

[POWER BLOCK]

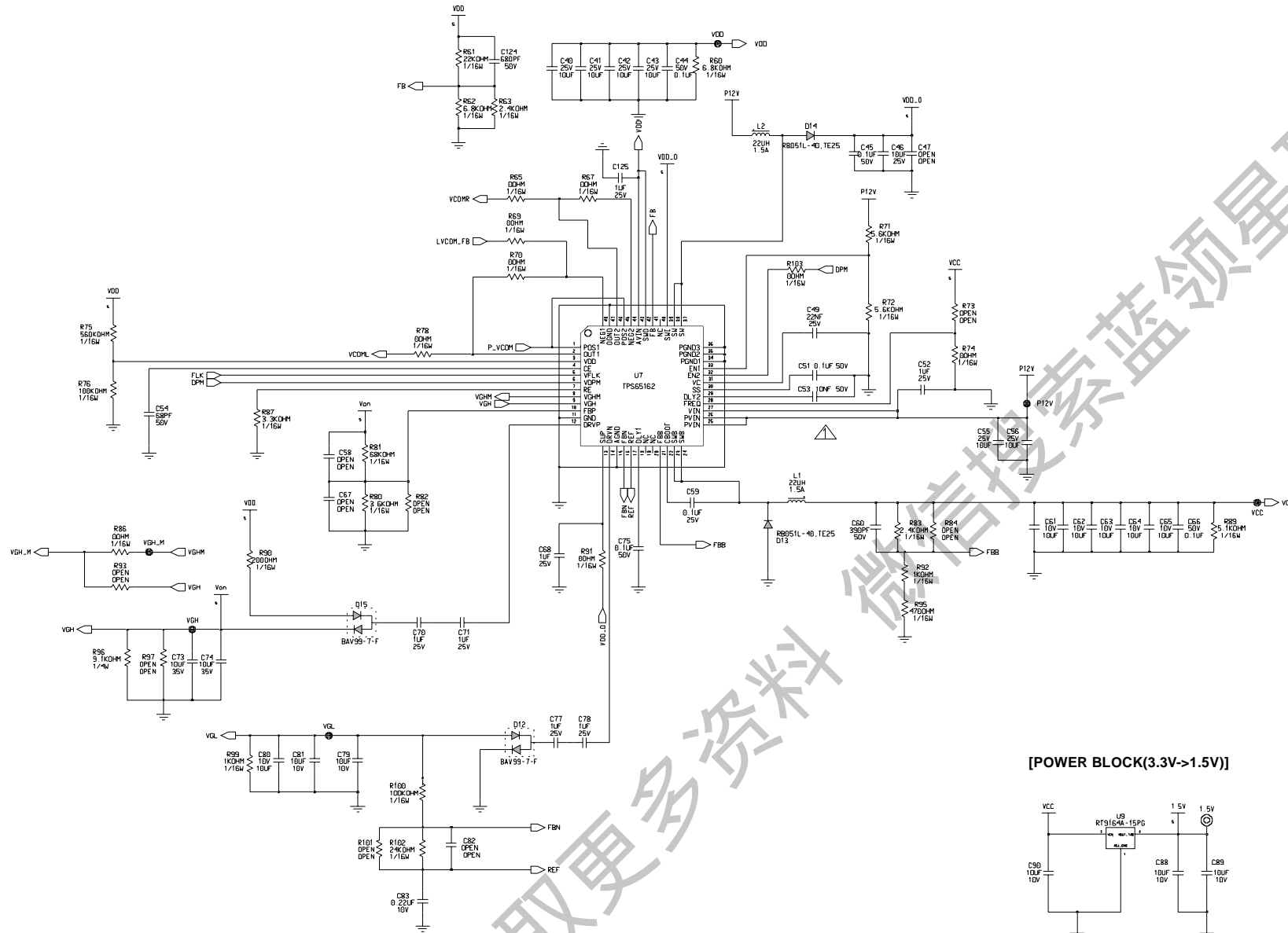

[P-VCOM BLOCK]

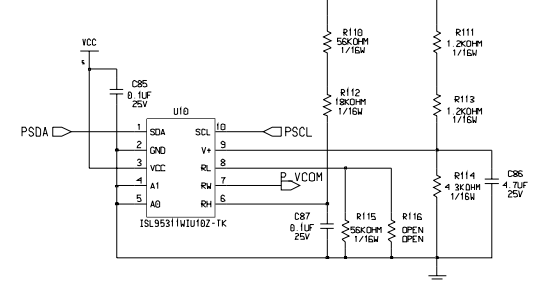

[MECH_CIRCUIT GND BLOCK]

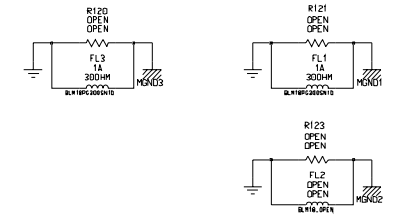

[POWER BLOCK(3.3V->1.5V)]

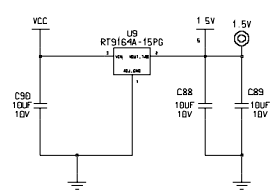

[SDRAM I/F BLOCK]

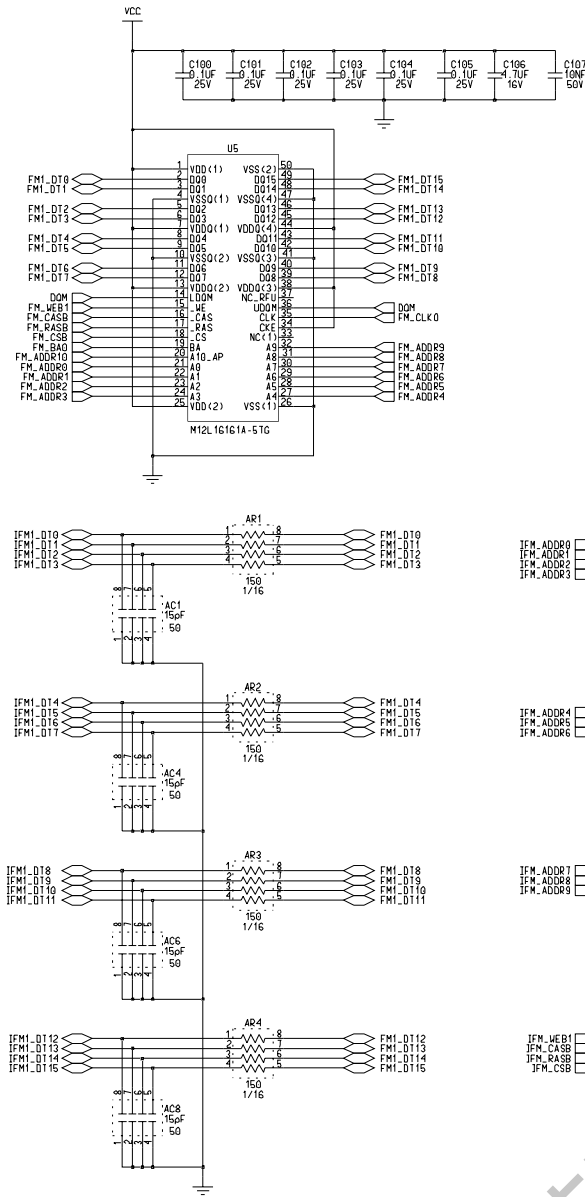

[AI I/F BLOCK]

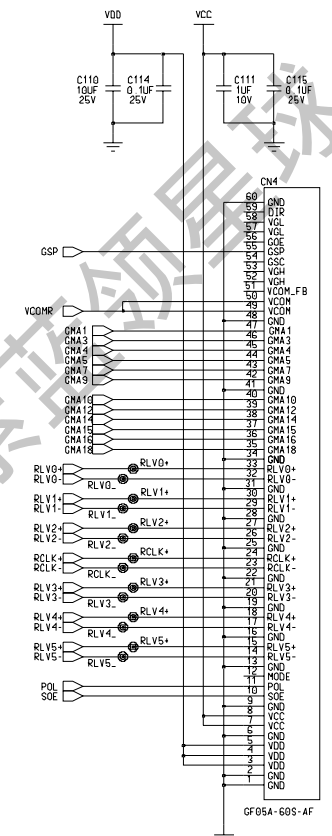
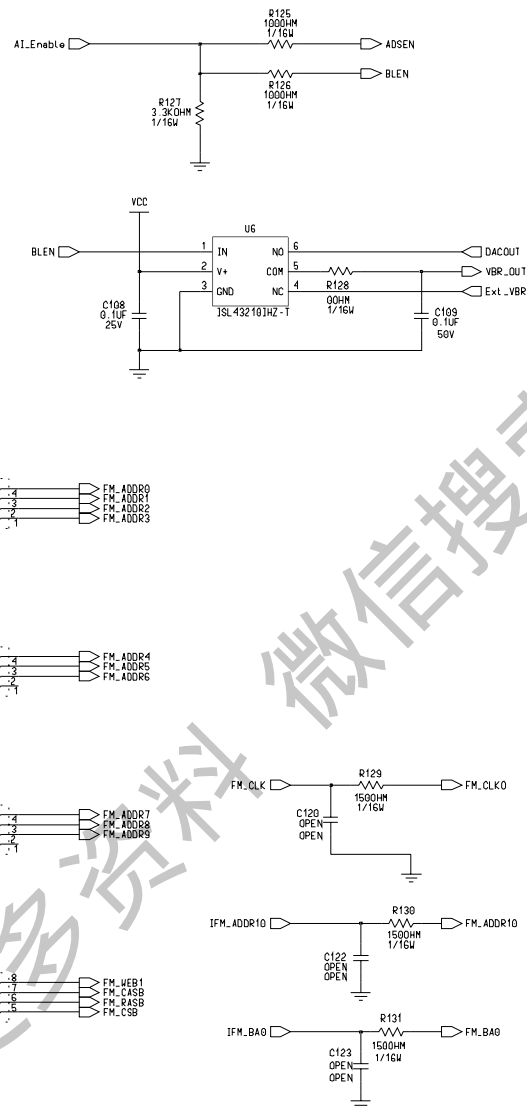

[CONTROL-SOURCE RIGHT CONNECTOR]

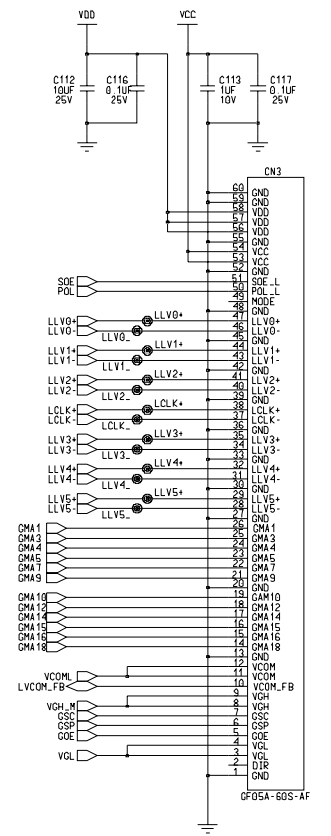

[CONTROL-SOURCE LEFT CONNECTOR]

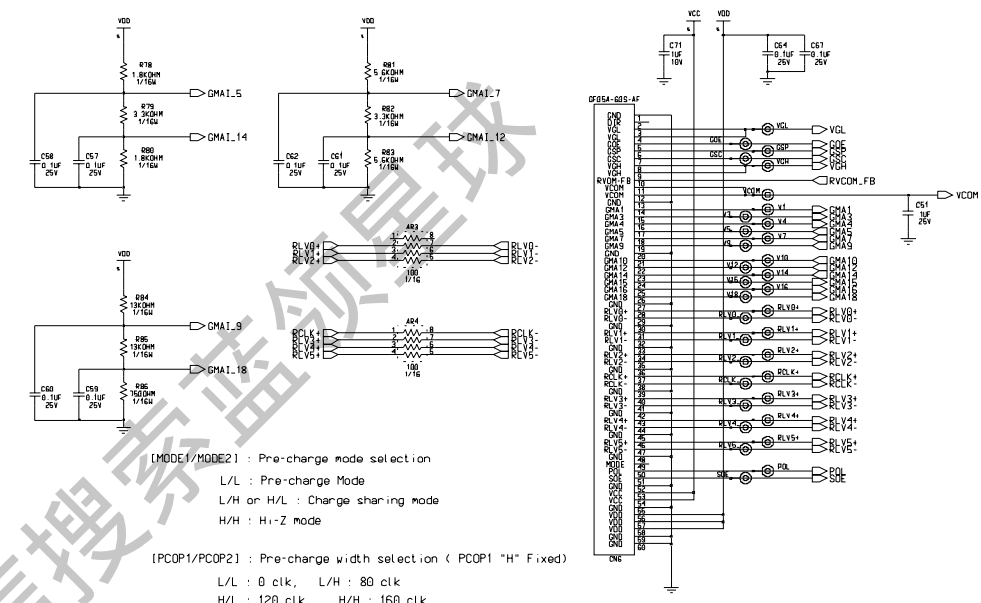
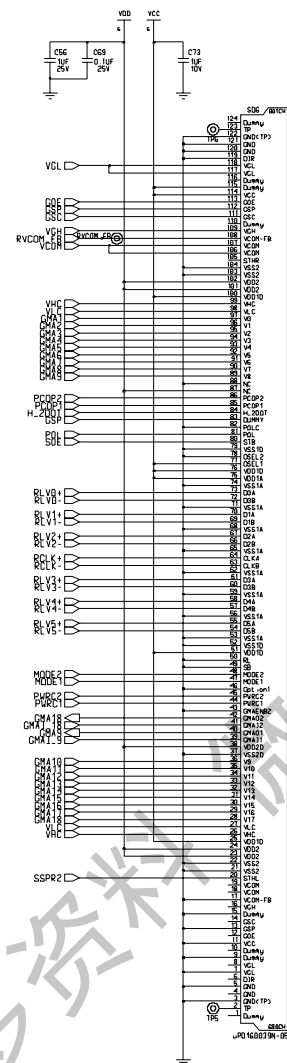
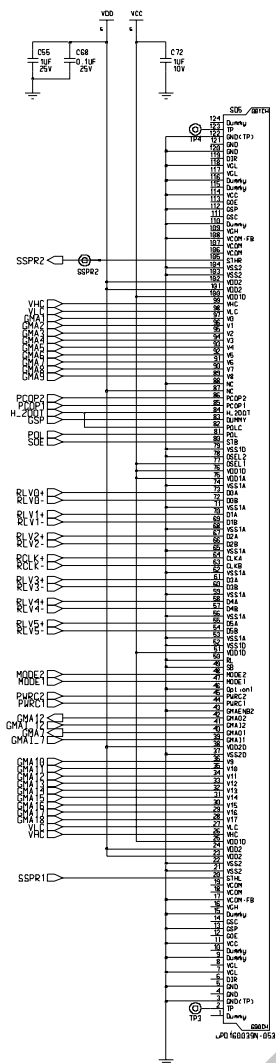
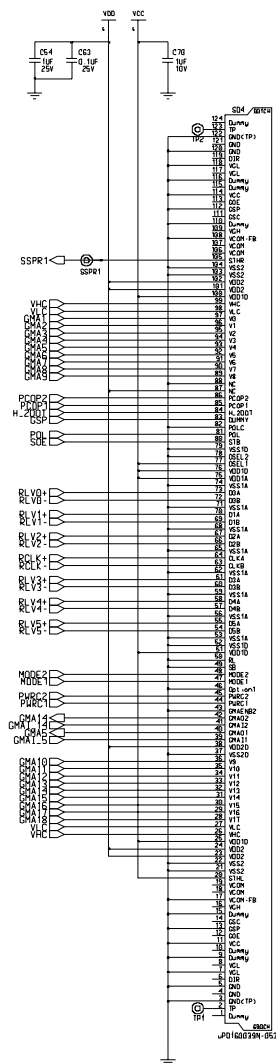

[MODE1/MODE2] : Pre-charge mode selection
 L/L : Pre-charge Mode
 L/H or H/L : Charge sharing mode
 H/H : Hi-Z mode

[PCOP1/PCOP2] : Pre-charge width selection (PCOP1 "H" Fixed)
 L/L : 0 clk, L/H : 80 clk
 H/L : 120 clk, H/H : 160 clk

[PWRC1/PWRC2] : Output power control (PWRC1 "L" Fixed)
 L/L : Minimum, L/H : Medium small
 H/L : Medium large, H/H : Maximum

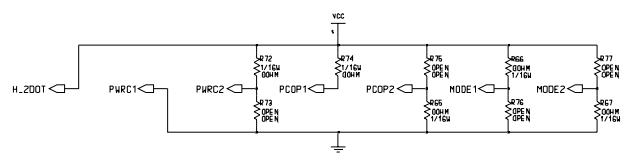
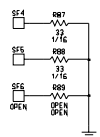

获取更多资料

Printed Circuit Board / 회로기판

Control(Top)

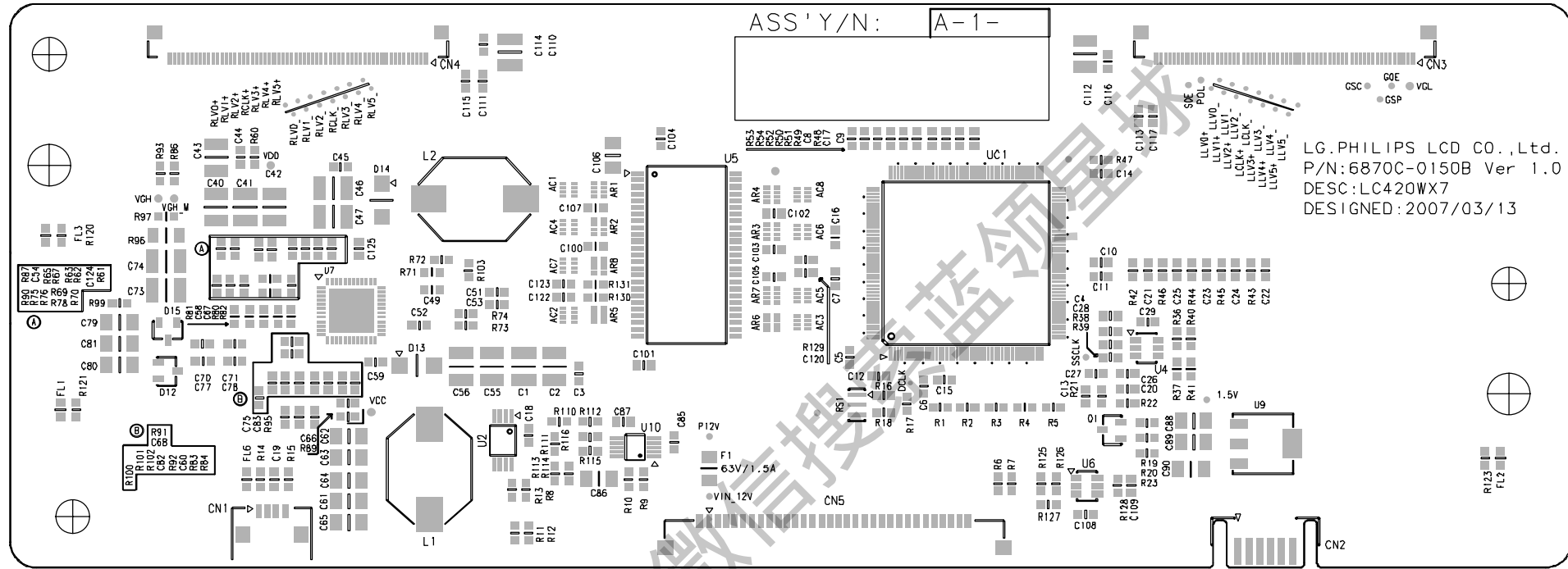

SOURCE(Left_Top)

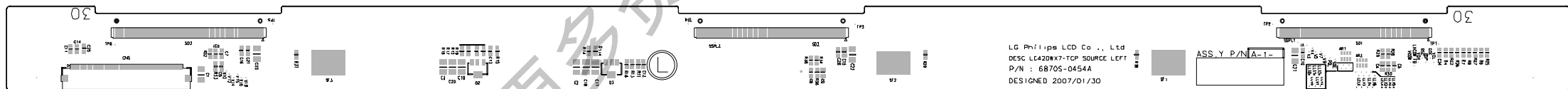

SOURCE(Right_Top)

