

获取更多资料 微信搜索 蓝领星球

[ DC/DC POWER BLOCK ]

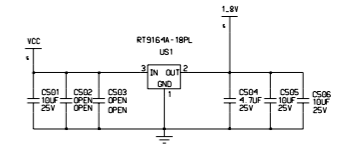

[ LED BLOCK ]

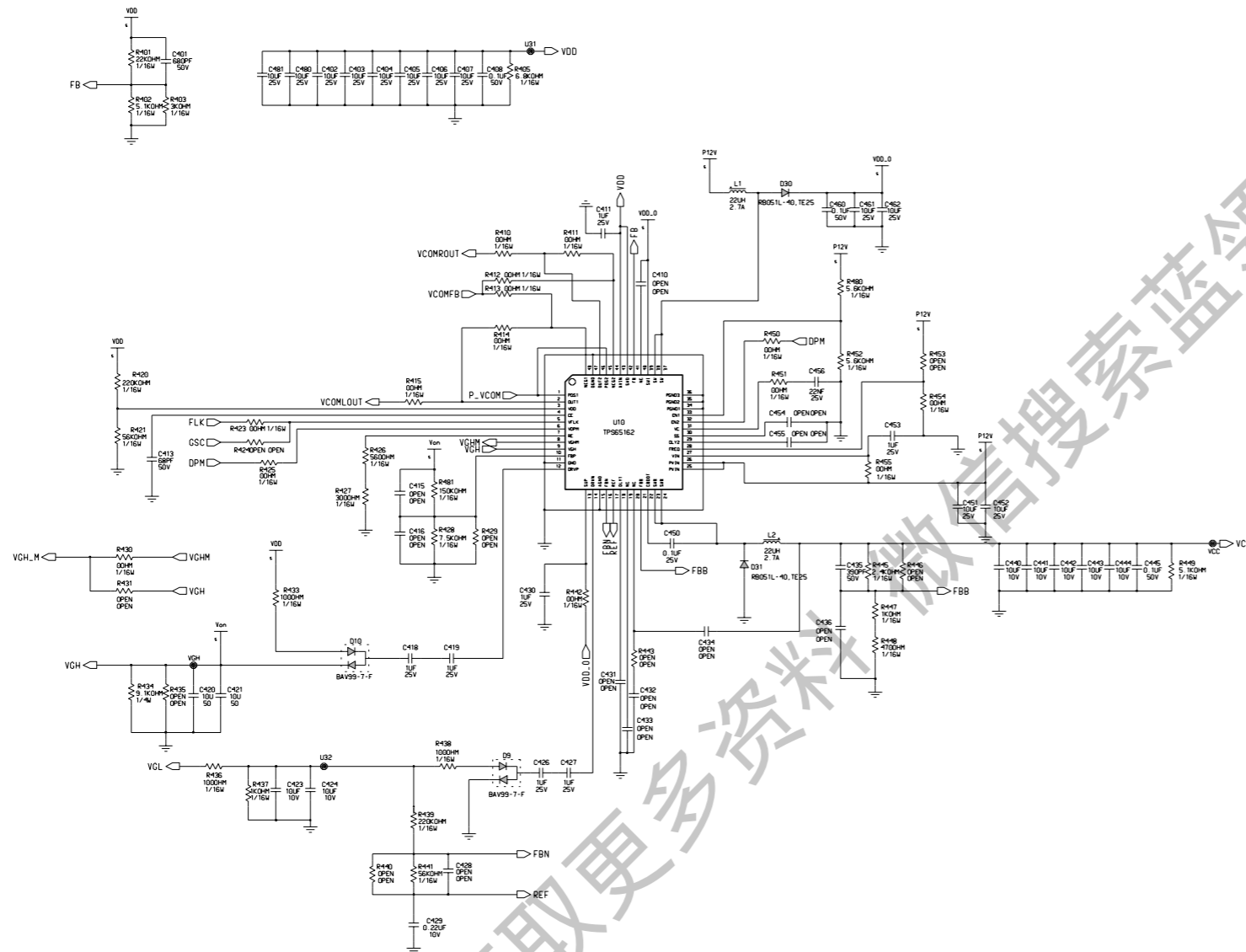
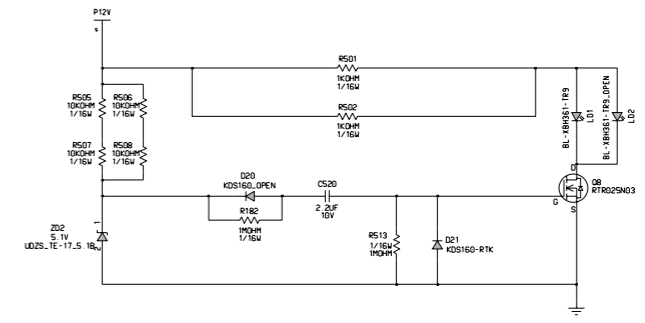

获取更多资料 微信搜索 蓝领星球

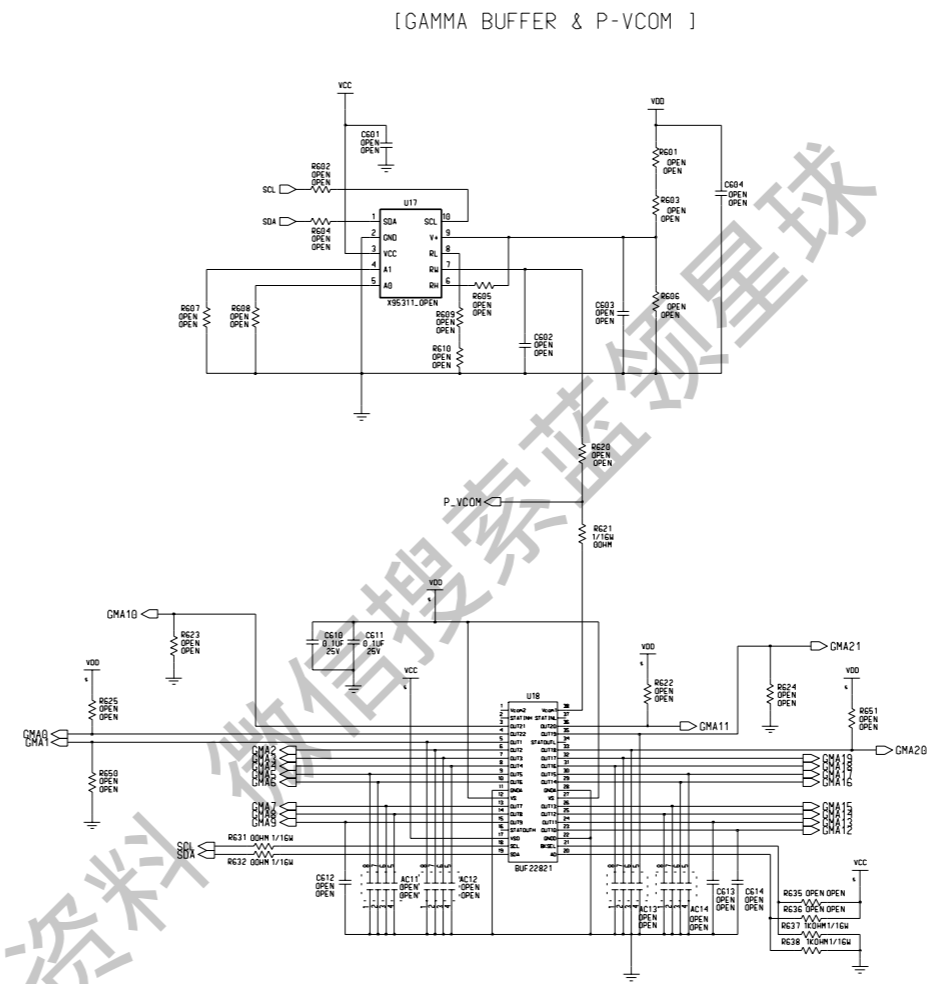
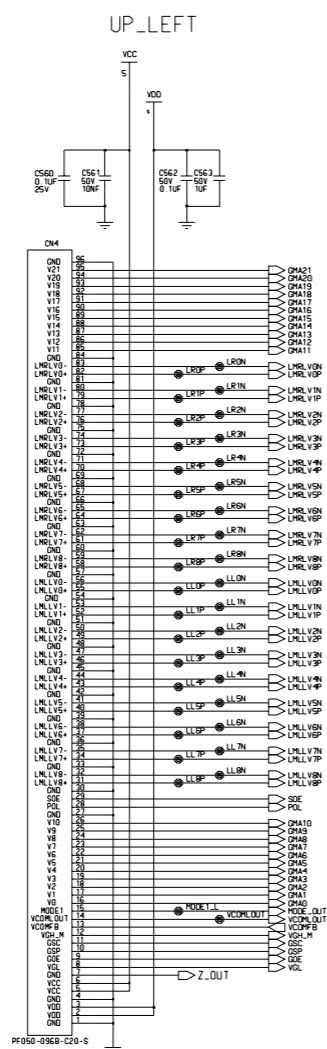
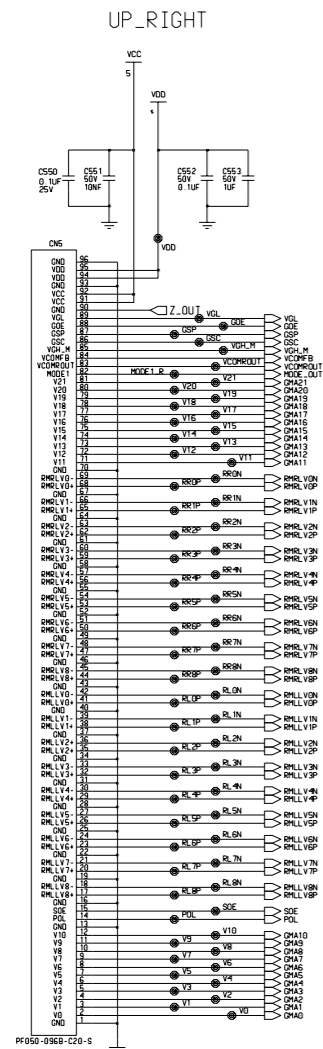

获取更多资料 微信搜索 蓝球星球

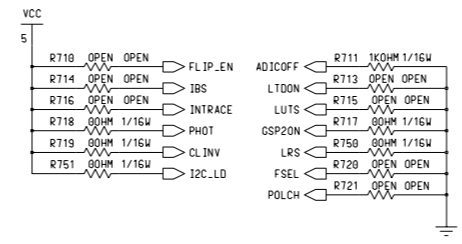
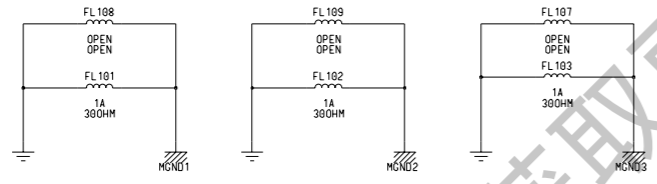
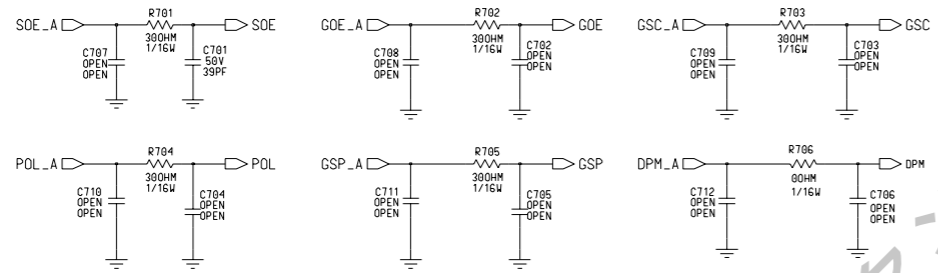
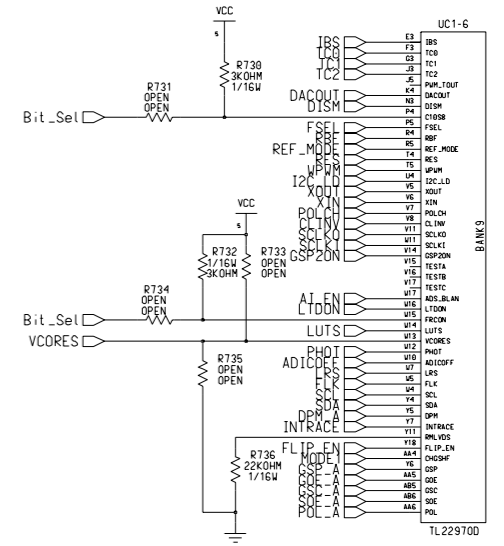
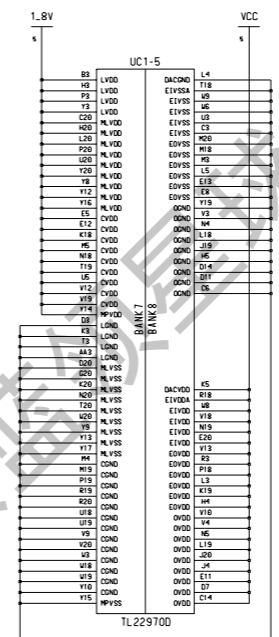
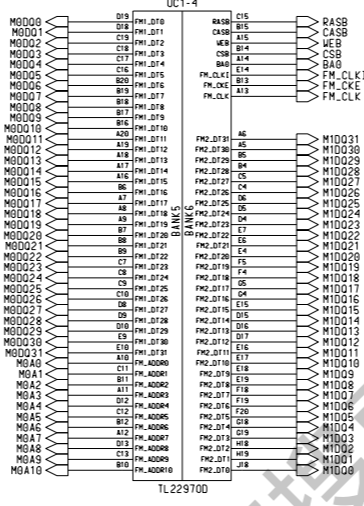
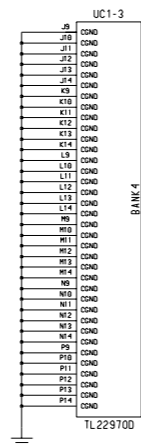
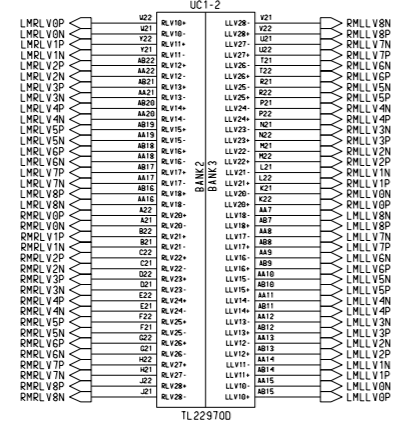
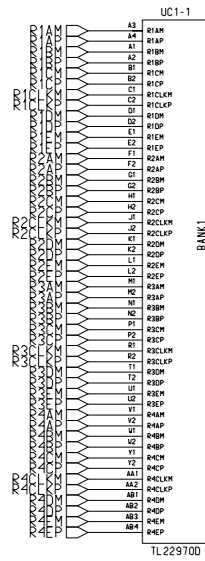

LC470WUD\_CONTROL  
CONTROL SCHEMATIC  
6871L-CONTROL

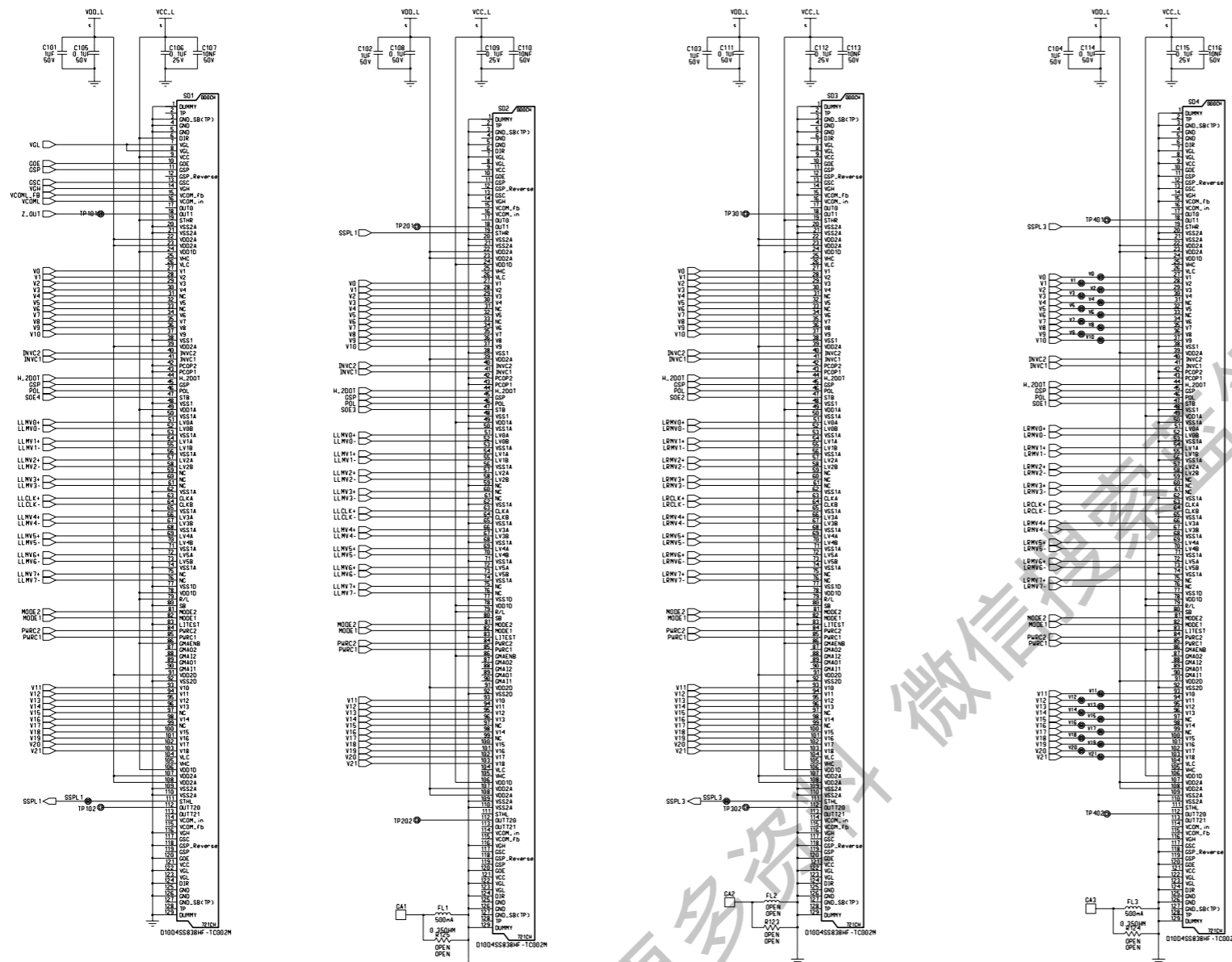

- [ H\_2DOT ] : INVERSION SELECT CONTROL  
L : Horizontal 2 Dot inversion Disable  
H : Horizontal 2 Dot inversion Enable
- [ SB ] : Bus-Line Set-Back Selection  
L : D0(+)  
H : D7(-) => D0(+)
- [ RL ] : Data Latch direction Control  
L : 720, 719 => 2.1  
H : 1, 2 => 719, 720
- [ DIR ] : Data Shift direction Control  
L : D102 => X270  
H : D101 => X1 => D102
- [ PWRC ] : Output buffer power Control  
HH : Maximum, HL : Medium Large, LH : Medium Small, LL : Minimum
- [ PCOP ] : Pre-charge width select  
HH : 320clk, HL : 240clk, LH : 160clk, LL : 0clk
- [ MODE ] : Output operation Control  
H : H-Z, HL : Charge Sharing, LL : Pre-charge
- [ GMAENB ] : Gamma buffer enable Selection  
H : Disable, L : Enable

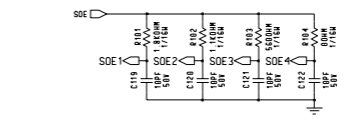

Mini-LVDS Termination

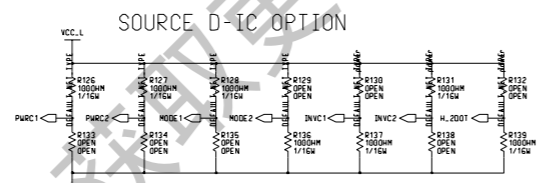
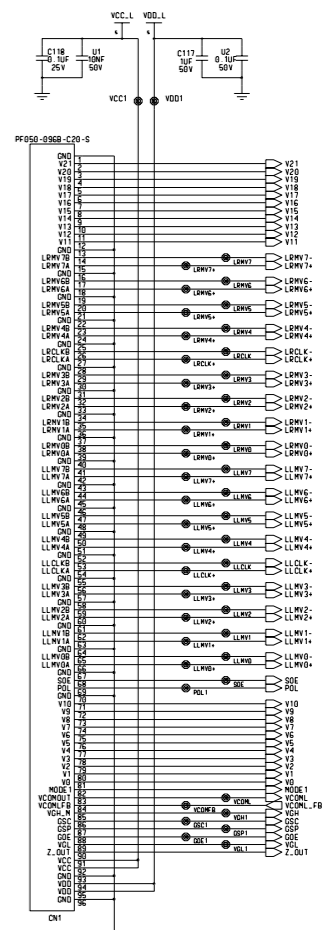
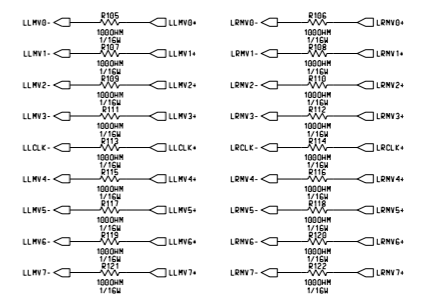

LC420WUD-SAA1-G31  
SOURCE LEFT SCHEMATIC

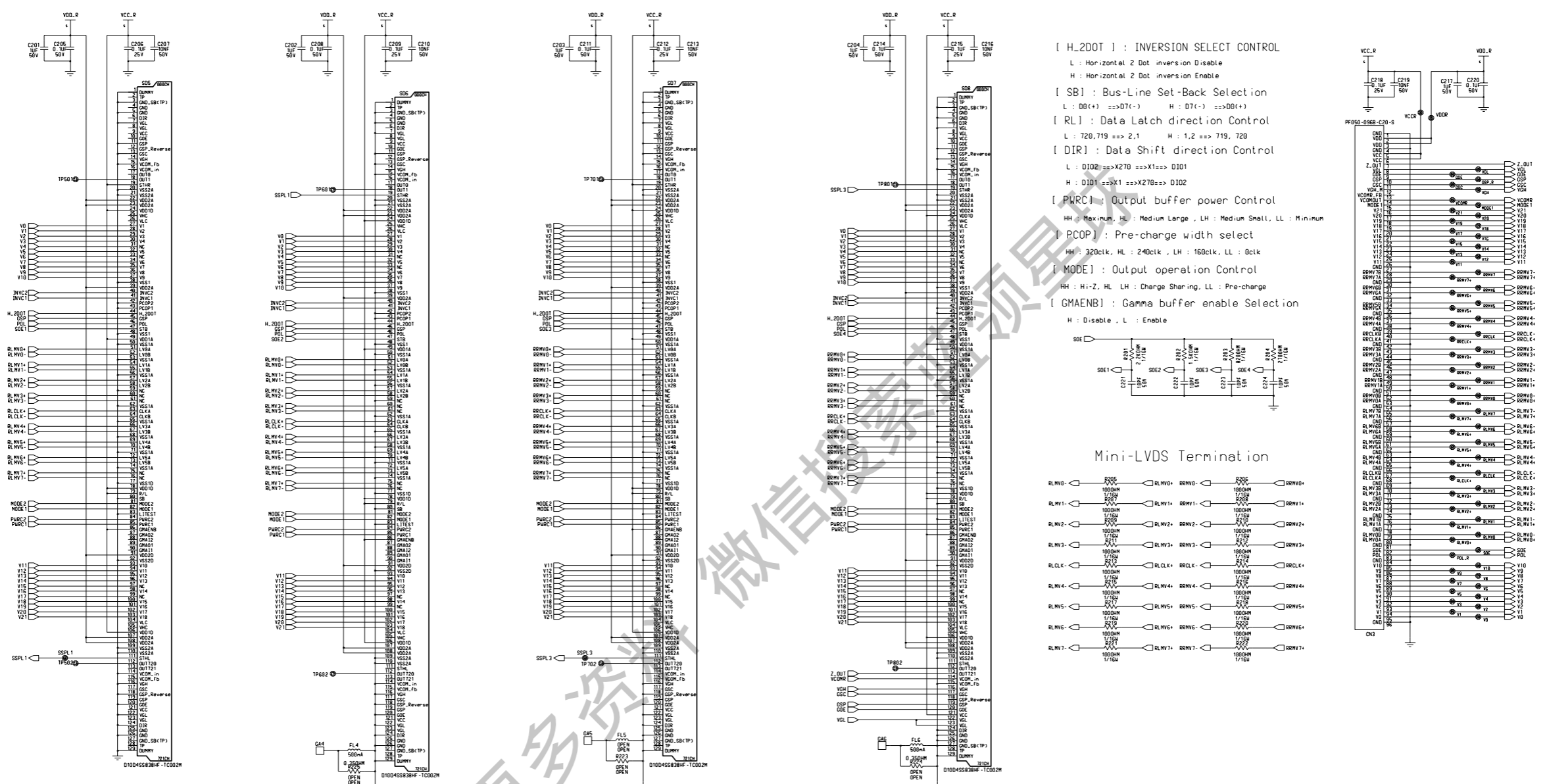

- [ H\_2DOT ] : INVERSION SELECT CONTROL  
L : Horizontal 2 Dot inversion Disable  
H : Horizontal 2 Dot inversion Enable
- [ SB ] : Bus-Line Set-Back Selection  
L : D0(+) ==>D7(-)    H : D7(-) ==>D0(+)
- [ RL ] : Data Latch direction Control  
L : 720,719 ==> 2,1    H : 1,2 ==> 719, 720
- [ DIR ] : Data Shift direction Control  
L : D102 ==>X270 ==>X1 ==> D101  
H : D101 ==>X1 ==>X270 ==> D102
- [ PWRC ] : Output buffer power Control  
HH : Maximum, HL : Medium Large, LH : Medium Small, LL : Minimum
- [ PCOP ] : Pre-charge width select  
HH : 320clk, HL : 240clk, LH : 160clk, LL : 0clk
- [ MODE ] : Output operation Control  
HH : Hi-Z, HL : Charge Sharing, LL : Pre-charge
- [ GMAENB ] : Gamma buffer enable Selection  
H : Disable, L : Enable

Mini-LVDS Termination

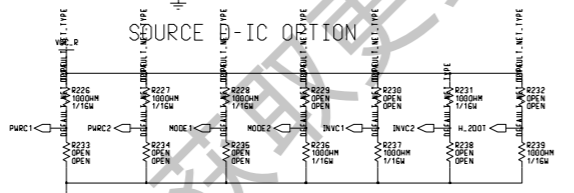
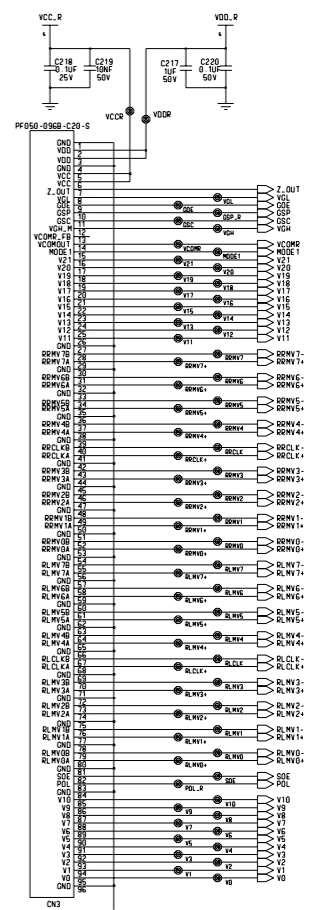
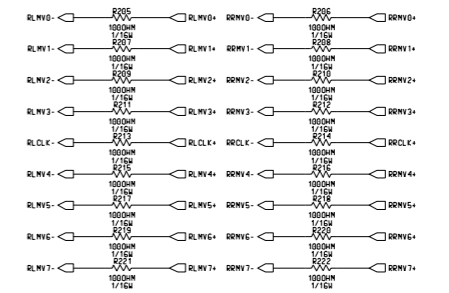

LC420WUD-SAA1-G31  
SOURCE RIGHT SCHEMATIC

# Printed Circuit Board / 회로기판

## SOURCE(Right\_Top)

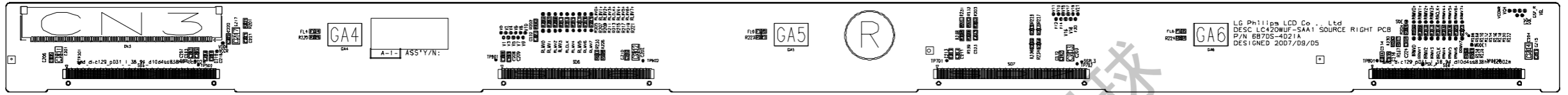

## SOURCE(Left\_Top)

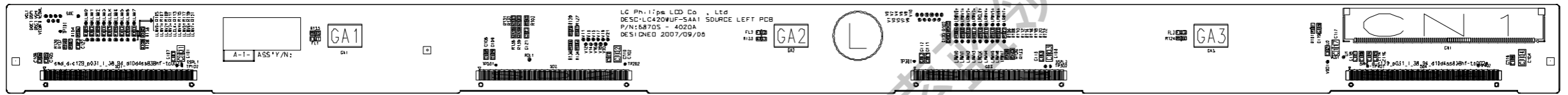

## Control(Top)

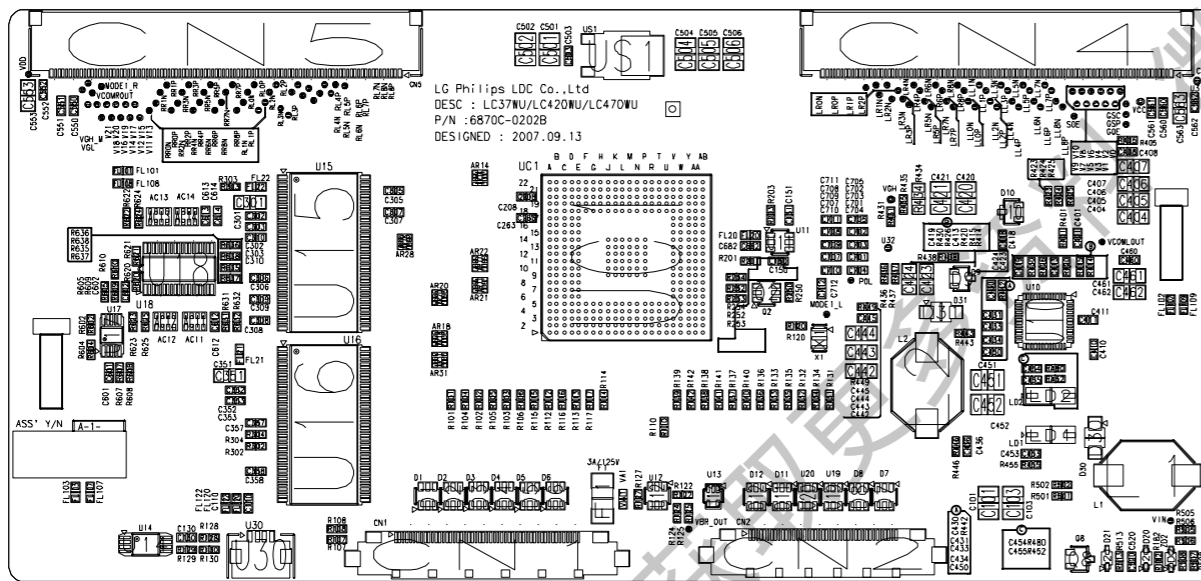

## Control(Bottom)

