

[FRCEN] : FRC (Other) Function Selection Pin  
 H : Enable, L : disable(Default value[OPEN] : "L")  
 [REVERSE] : Reverse option Selection Pin  
 (Default value[OPEN] : "L")  
 [DISM] LVDS Data mapping selection Pin  
 L : LG Format, H : DISM Format  
 (Default value [OPEN] : "L")  
 [OPC.EN] : OPC Function Enable Pin  
 H : Enable, L : disable(Default value[OPEN] : "H")  
 [FGD.EN] : The function to improve interface  
 H : Operating Mode, L : Bussess mode  
 (Default value : "H")  
 [C10S8] : 10bit or 8bit selection Pin  
 L : 8bit, H : 10bit(Default value : "H")

CONTROL SCHEMATIC(1/2)  
 LC470/550WUD-SBA1-731  
 6870C-4000A

[RIGHT FFC CONNECTOR]

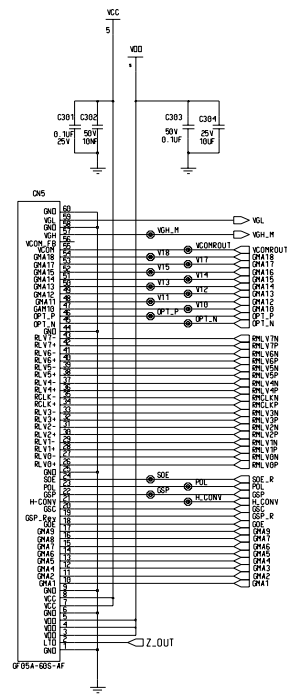

[LEFT FFC CONNECTOR]

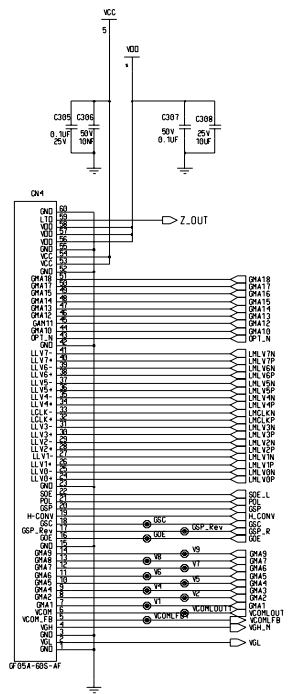

[POWER BLOCK]

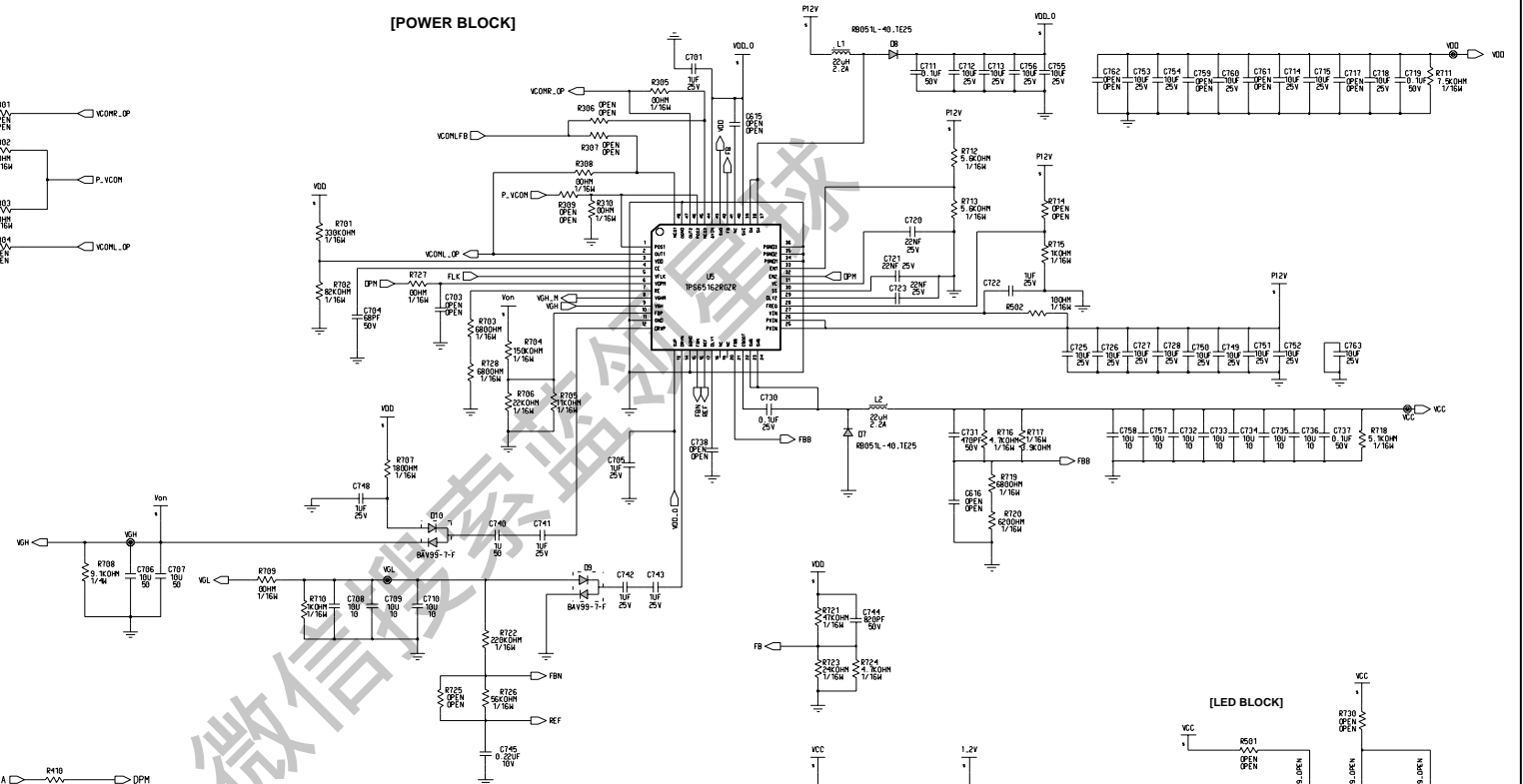

[P-GMA BLOCK]

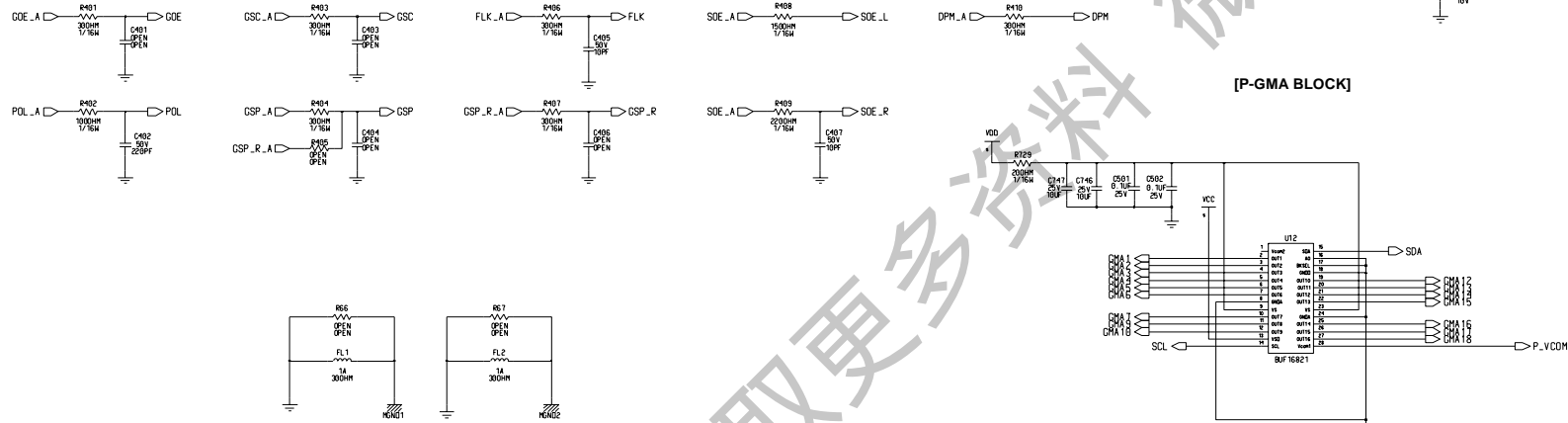

[LED BLOCK]

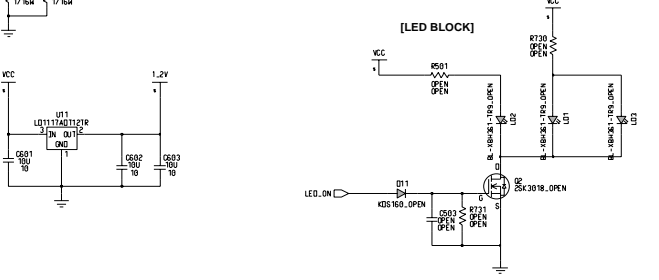

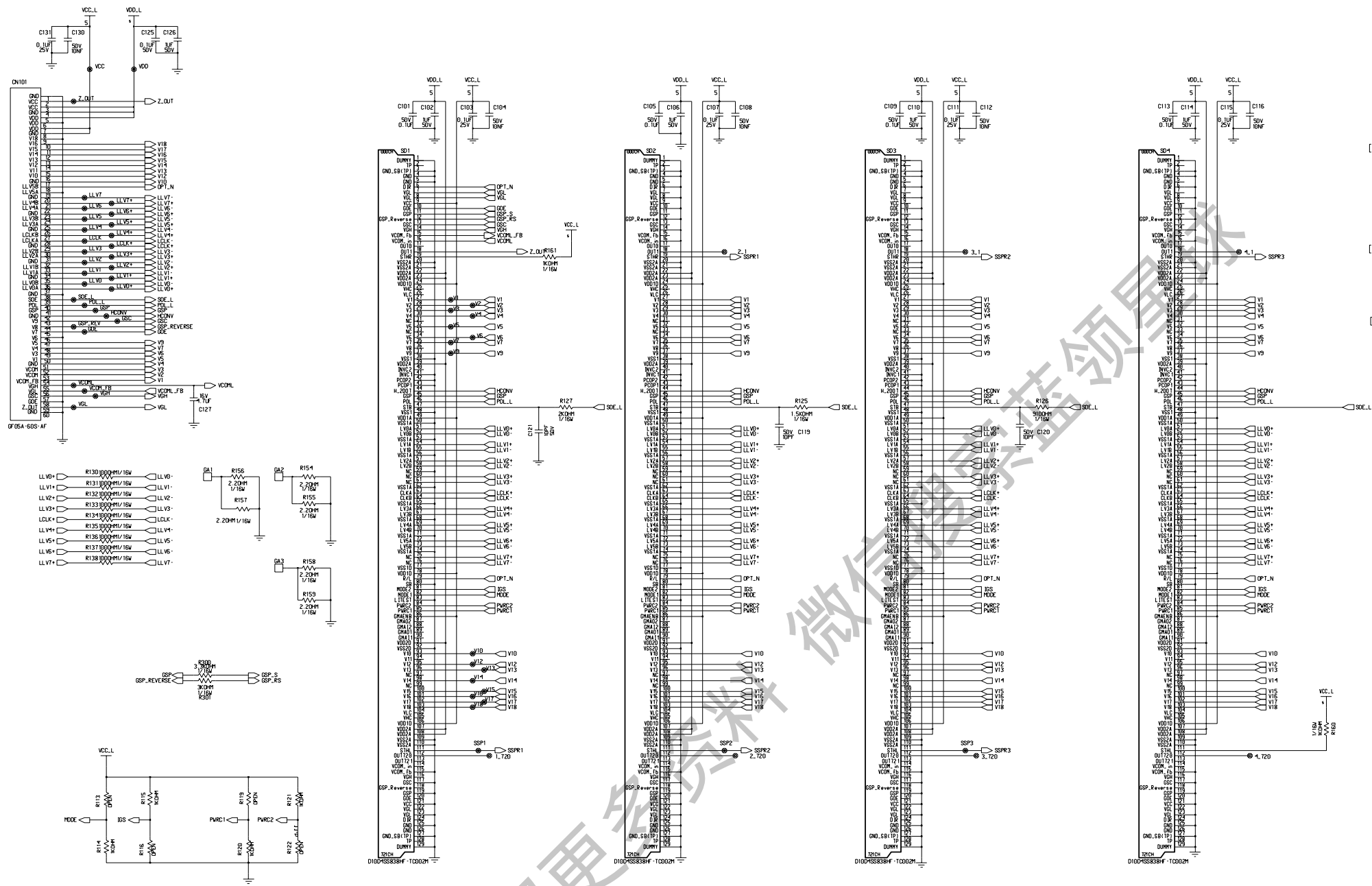

[PWRC1/PWRC2] : Output buffer power control  
 H/H : High Power Mode  
 H/L : Normal Mode  
 L/H : Low Power Mode  
 L/L : Ultra Low Power Mode

[MODE] : Output status control  
 High : Hi-Z  
 Low : Charge Sharing

[IGS] : Independent GMA selection (Full up)  
 High : IG OFF  
 Low : IG ON

获取更新资料

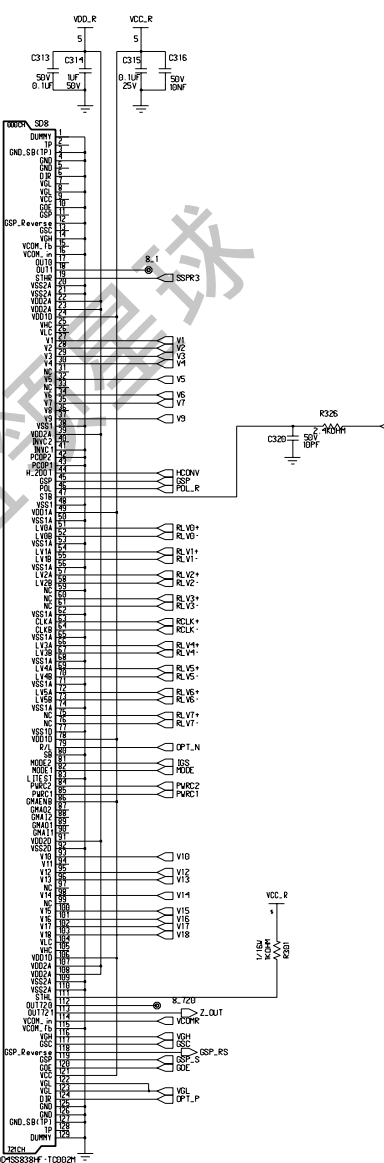
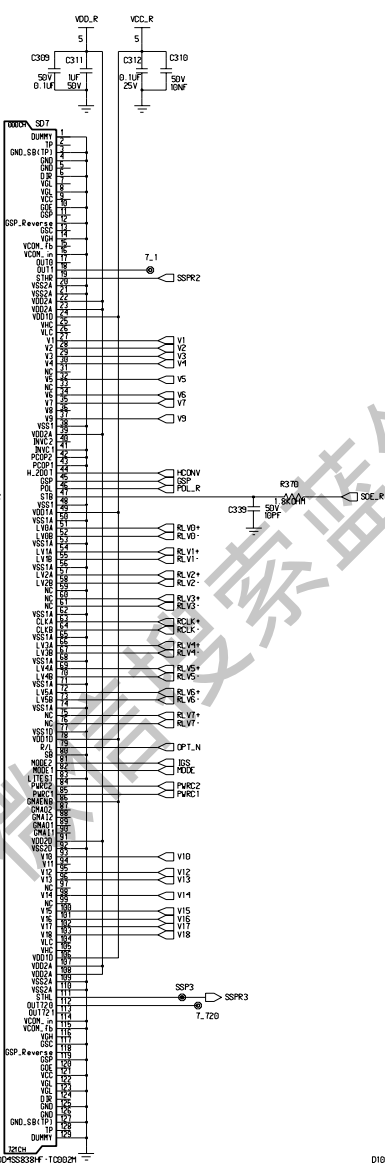
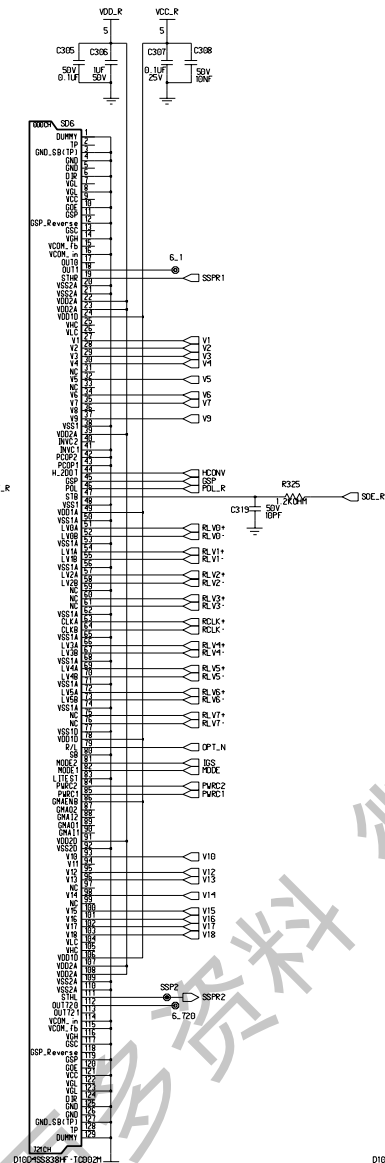
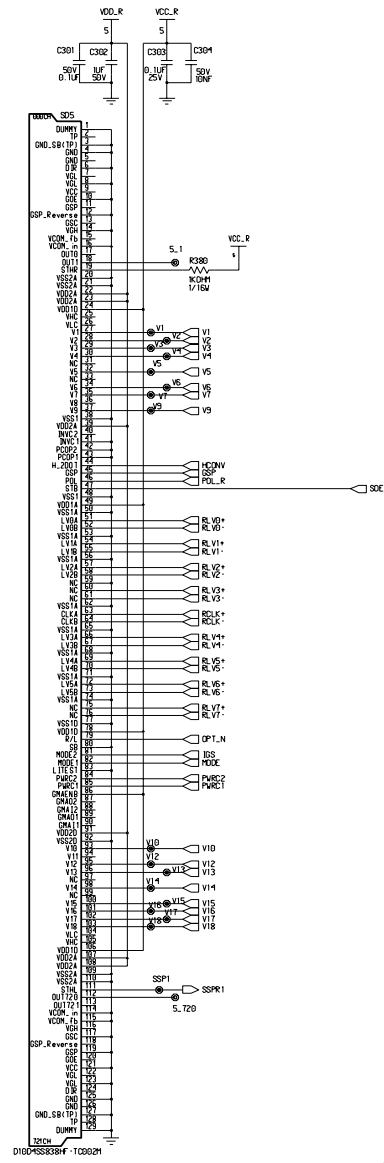
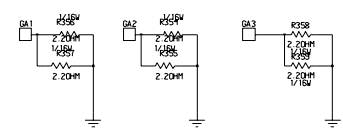
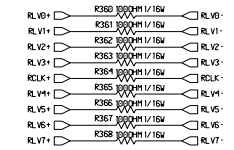
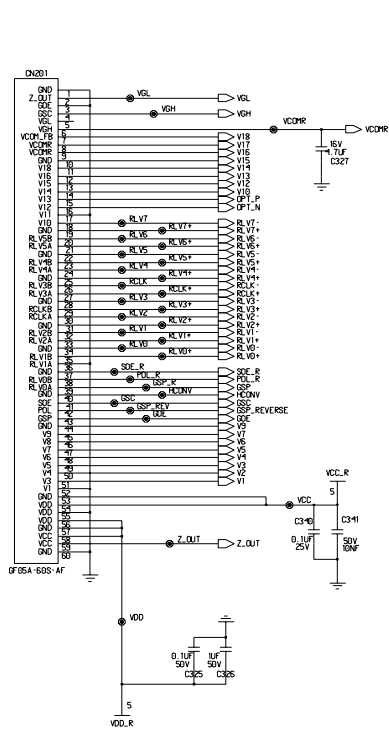

[PWRC1/PWRC2] : Output buffer power control  
 H/H : High Power Mode  
 H/L : Normal Mode  
 L/H : Low Power Mode  
 L/L : Ultra Low Power Mode  
 [MODE] : Output status control  
 High : Hi-Z  
 Low : Charge Sharing  
 [IGS] : Independent GMA selection (Full up)  
 High : IG OFF  
 Low : IG ON

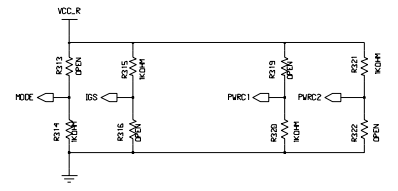

获取更多资料

Control(Top)

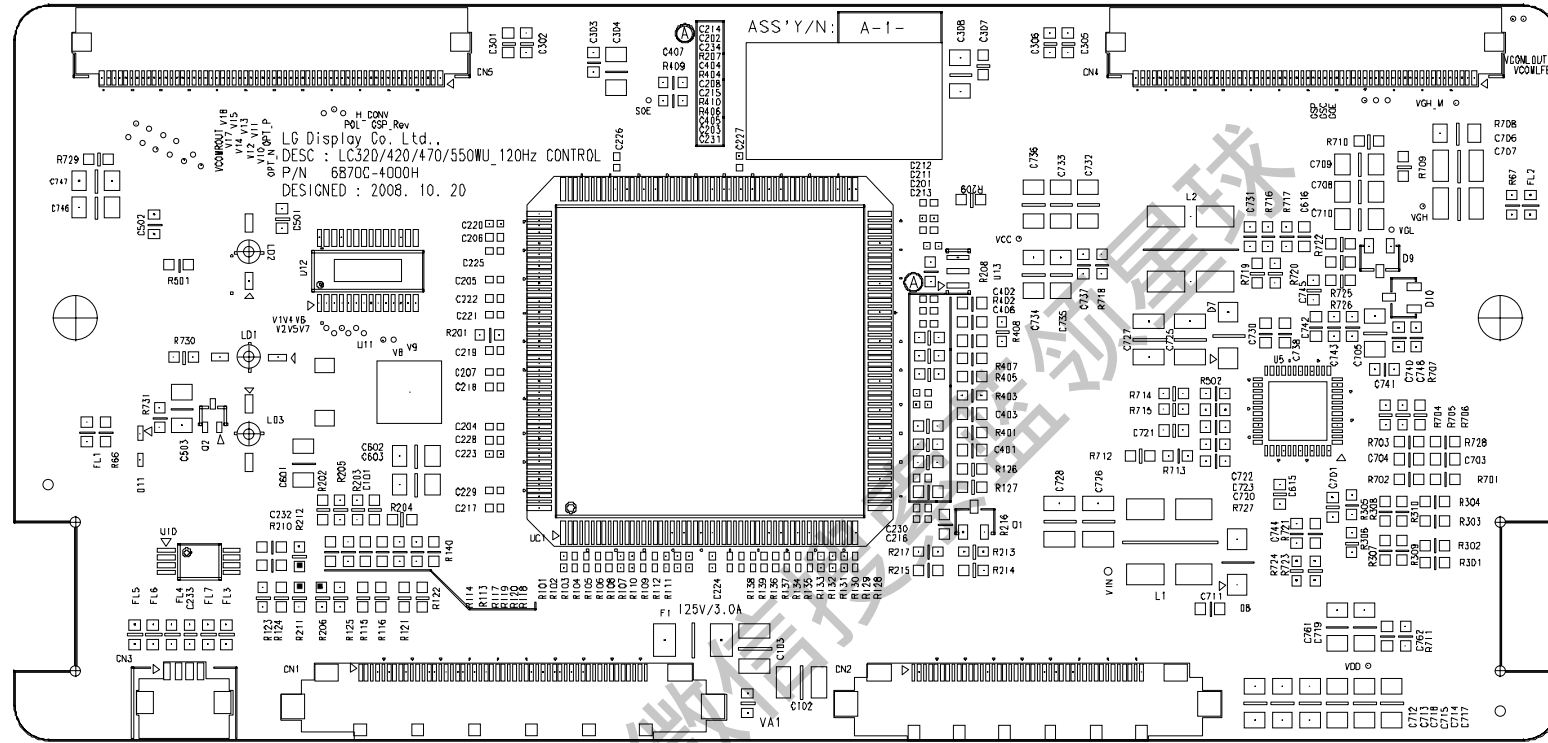

Control(Bottom)

