

使用說明書

OPERATING INSTRUCTIONS

R410A

MSD-CF09VB-H1

MSD-CF12VB-H1

⚠警告	由于處置錯誤將造成死亡、重傷或財產損失的可能性很大。
⚠注意	由于處置錯誤，可能造成空調機不能正常使用或造成損失。

⚠ WARNING	Incorrect handling could cause a serious hazard, such as death, serious injury, property loss etc. with a high probability.
⚠ CAUTION	Incorrect handling could make the conditioners not working normally or causing damage.

目 錄

安全事項	1
各部件名稱	5
操作前的準備工作	6
"I FEEL..."(體感...)自動運轉	8
用戶自己選擇運轉模式時(冷氣·除濕·送風)	10
風速·風向的調節	12
定時器設定(定時關·定時開)	14
長期不使用時	15
室內機外觀的清掃方法	16
前面板的拆下和安裝方法	17
茶精清新網的清掃	18
在請維修人員之前，請再次檢查以下項目	19
當您認為「發生故障？」時	20
安裝·移機·檢查	22
技術性能表	23

CONTENTS

SAFETY PRECAUTIONS	24
NAME OF EACH PART	28
PREPARATION BEFORE OPERATION	29
"I FEEL..."AUTO OPERATION	31
MANUAL OPERATION(COOL, DRY, FAN)	33
AIR FLOW VELOCITY AND DIRECTION ADJUSTMENT	35
TIMER OPERATION(OFF TIMER-ON TIMER)	37
WHEN THE AIR CONDITIONER IS NOT GOING TO BE USED FOR A LONG TIME	38
MAINTENANCE	39
METHOD OF DISASSEMBLY AND INSTALLATION OF THE FRONT PANEL	40
CLEANING THE CATECHIN FILTER	41
BEFORE CONTACTING THE SERVICEMAN, CHECK THE FOLLOWING AGAIN	42
WHEN YOU THINK THAT TROUBLE HAS OCCURED	43
INSTALLATION, RELOCATION AND INSPECTION	45
SPEC DATA	46

非常感謝您選用三菱電機房間空調器。

- 爲了確保正確安全地使用本機，在使用前，請一定先閱讀說明書。閱讀以後請妥善保存，以備必要時查閱。
- 購買機器時，須在出售店收取記載有「購買日期·店名」的有效證明。
- 顧客請不要自己安裝機器(自行安裝，將不能保證安全和功能)。

Thank you very much for purchasing this Mitsubishi room air conditioner.

- To use this unit correctly and safely, be sure to read this instruction manual before use. Keep this manual carefully for later reference.
- Be sure to receive a guarantee card from your dealer and shop name, etc. are entered correctly.
- This air conditioner should not to be installed by the customer (Safety and performance functions cannot be assured).



安全事項

- 使用前，一定請先詳讀此「安全事項」。
- 這裏所示的注意事項，是一些有關安全的非常重要的內容，一定要遵守。

文中所用“圖符號”的意思如下。

	絕對不可做。
	一定請按指示做。
	一定要接地線。
	一定請拔下電源線插頭。
	禁止踩到室內/室外機組上面或在它們上面堆放東西。
	請小心觸電的危險。
	禁止插進指頭或棒條等。

- 閱讀后，請和安裝說明書一起收藏在使用者容易發現的地方。

禁止在放置或使用揮發性、腐蝕性、可燃性化學制品的環境中使用空調。

- 在室內使用揮發性、腐蝕性、可燃性化學制品(如二甲苯、香蕉水、甲醇等)期間，必須禁止使用空調。
- 室內裝修油漆未干，必須打開門窗，進行通風，等房間內各種稀釋劑氣體揮發散盡，方可使用空調。
- 否則會引起機器腐蝕、變形，甚至引起火災。

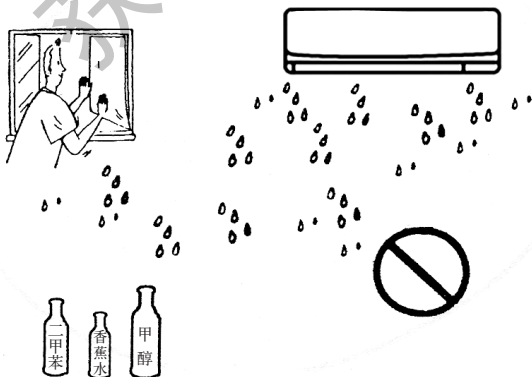

警告

禁止在電源綫的中途引綫或延長電源綫及禁止使用多孔插座。

- 可能因接觸不良、絕緣不良、超過允許電流量而會引起火災、觸電事故。

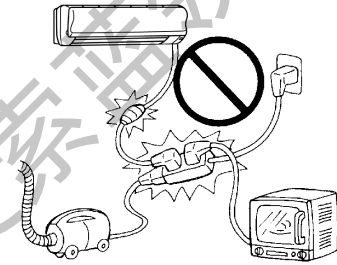

清除電源插頭上的灰塵，接插穩固。

- 若附着灰塵，或沒有插好，便有引起火災、觸電的可能。

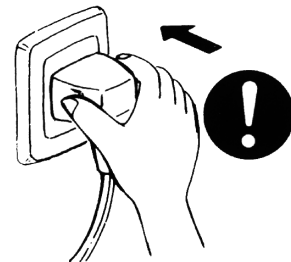

禁止損傷電源綫，或作連接加工。

- 若在電源綫上堆放重物、或加熱、連接加工，便有可能因短路而引起火災、觸電事故。

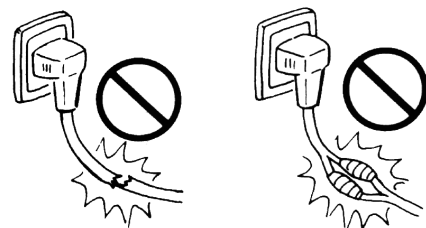

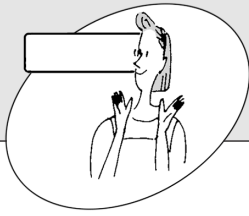

安全事項

警告

運轉中，禁止拔下電源插頭。

- 可能產生火花，引起火災事故。

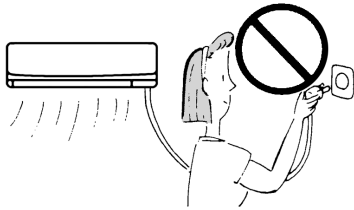

禁止在進風或排風口或出風口插入手指或棒條。

- 裏面有高速旋轉的風扇，會造成人身傷害。



禁止拉電源綫。

- 要卸下電源綫時，必須抓住插頭拔下。因為可能拉斷電源綫中的一部分芯綫而引起火災事故。



禁止用水洗刷空調機。

- 機器中如果進水，會降低絕緣性能，有發生觸電的危險。

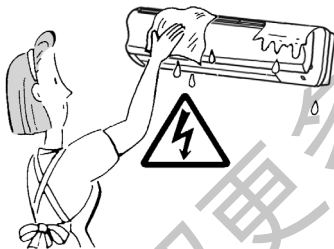

用戶不可自己進行修理或移設。

- 因為若處理不當，將可能引起火災、觸電、機器掉落傷人或漏水。請與出售店或技術服務中心聯系。

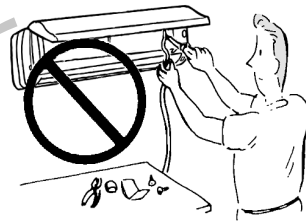

打掃時，應停止運轉，拔下電源插頭。

- 因為運轉中，有高速旋轉着的風扇可能傷人。

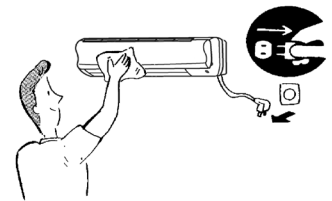

發覺異常時(有燒焦味等)，應立刻停止運轉，拔去電源插頭。

- 發覺異常而繼續運轉下去時，將引起故障。請與出售店或技術服務中心聯系。



不要自己安裝機器。

- 因為若安裝不當，將可能引起火災、觸電、機器掉落傷人或漏水。請與出售店或技術服務中心聯系。

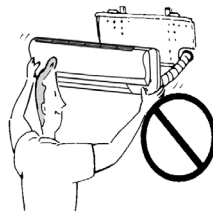

禁止用潮濕的手去操作開關。

- 有觸電的危險。



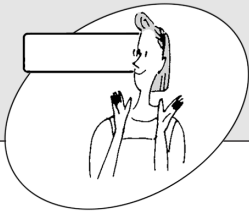

安全事項

警告

不要長時間讓冷風直吹肌膚。

- 可能會損害身體健康。

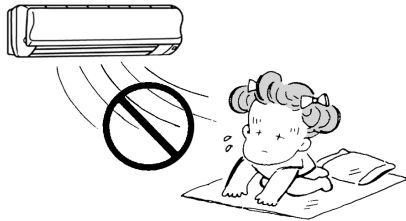

裝、卸面板時，禁止站在不穩固的腳臺上。

- 可能跌倒受傷。

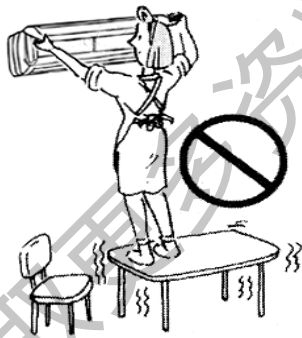

禁止用殺蟲劑、消毒劑、可燃性噴霧材料噴吹。

- 可能引起火災、變形。

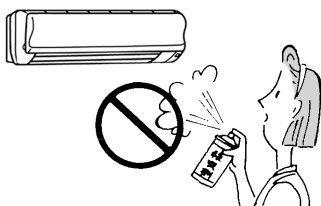

和燃燒器具一起使用時，應該時常換氣。

- 可能產生氧氣不足的現象。

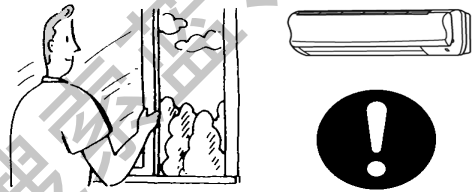

在拆卸茶精過濾網時，小心不要碰到室內機組的金屬部分。

- 有被刮傷的可能。



禁止燃燒器具放在直接吹得到風的地方。

- 可能引起燃燒器具的不完全燃燒。

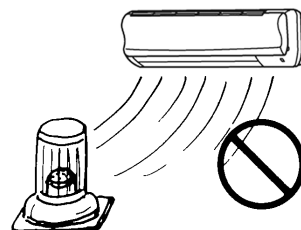



安全事項

警告

長期不使用機器時，應拔下電源插頭。

- 因堆積灰塵而有可能引起火災的危險。

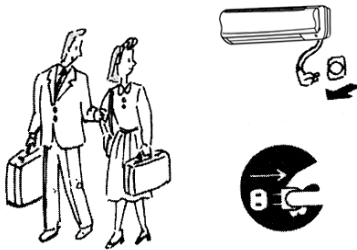

禁止到室外機組上去，或在上堆堆東西。

- 可能跌下受傷

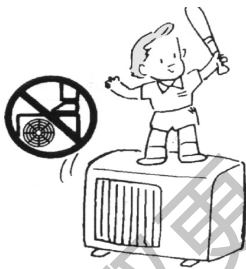

安裝臺如果已陳舊不堪，不可置之不理。

- 機組有翻倒傷人的可能。

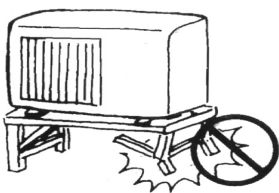

- 安裝機器，請與購買機器的出售店或技術服務中心聯系。

必須接地線。

- 空調插座應連接有專門接地線，地線切勿接到煤氣管、自來水管、避雷針導線、電話接地線上。
- 如果沒有接地線或地線沒有連接好，可能引起觸電事故。
- 在使用前請務必確認是否有接地線或接地線是否按要要求連接。



某些安裝場所(例如濕氣高的地方等),須安裝漏電斷路器。

- 若不裝漏電斷路器，便可能有觸電的危險。



禁止安裝在有可能泄漏腐蝕性、可燃性氣體的地方。

- 萬一氣體泄漏并聚集在機組周圍時，便有發生爆炸或損壞機器的危險。



排水口須保證能順利排水。

- 如果有排水不良狀況，機組將可能滴水浸濕污損家具。



注意

禁止開放着門窗，在高濕度狀況下作長時間的運轉。

- 開冷氣時，若在高濕度(80%以上)下作長時間連續運轉，空調機可能有冷凝水滴下，浸濕污損室內家具。

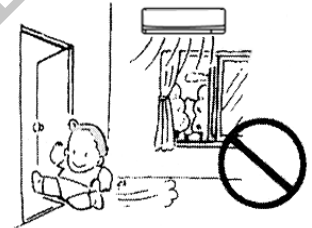

禁止當其它特殊用途。

- 不能作為保存精密機器、食品、動植物、美術品的用途。因為有降低保存品質的可能。

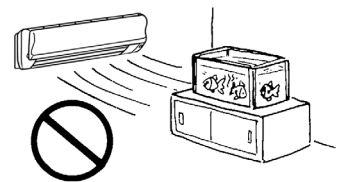

禁止在直接吹到風的地方放置動植物。

- 可能對動植物有不良影響。

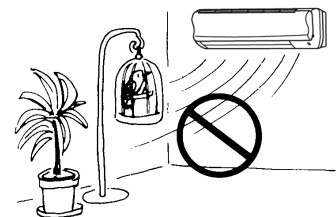

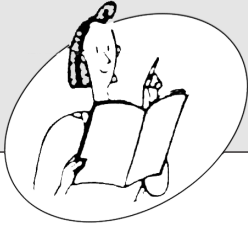

各部件名稱

室內機組

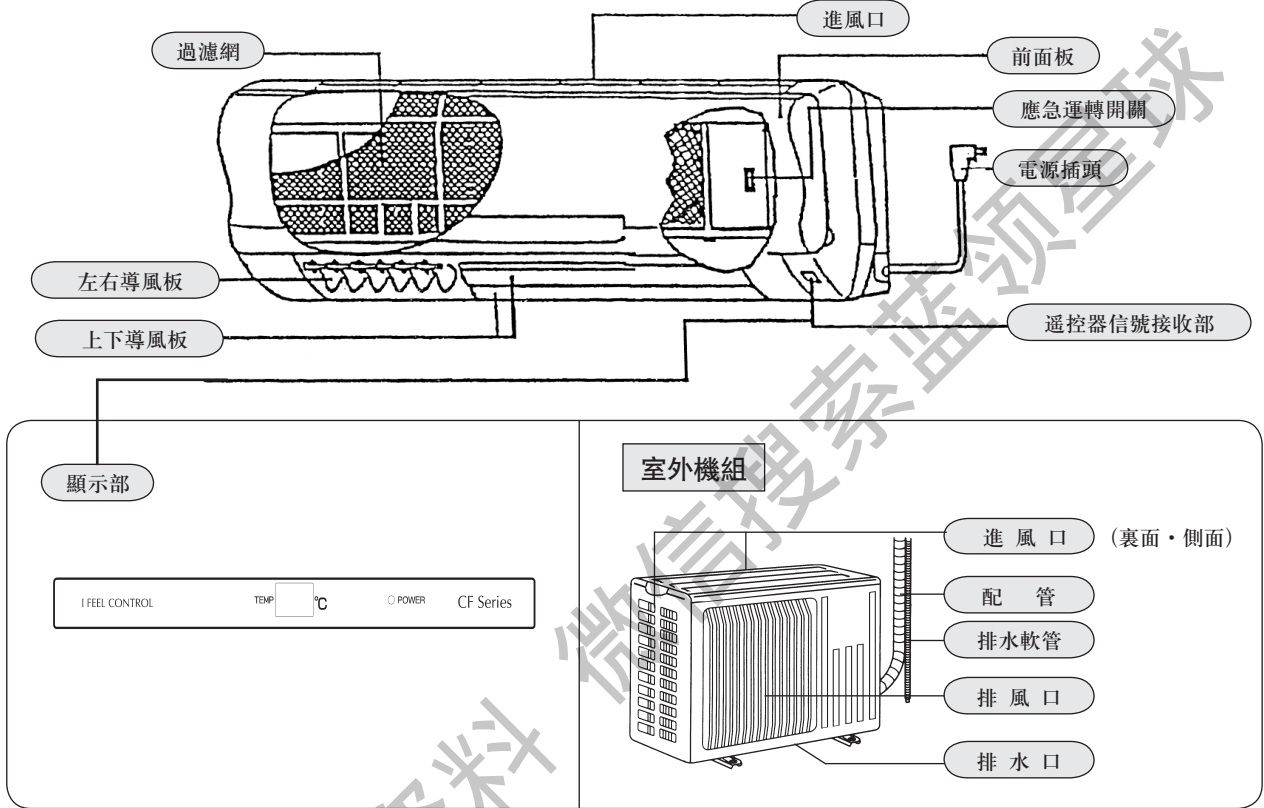

遙控器

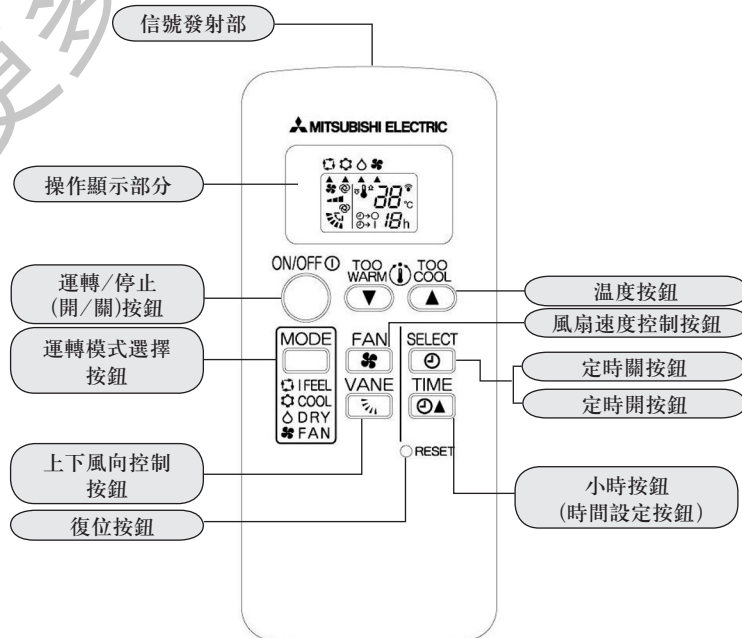



操作前的準備工作

自動重新啓動功能

該機型具有自動重新啓動功能，但在工廠出貨時，此功能設為關閉。如您需要使用自動重新啓動功能，請與技術服務中心聯繫。

自動重新啓動功能就是...

當使用遙控器控制室內機組時，記憶體記憶運轉模式，設定溫度和風扇速度。如果運轉過程中發生斷電或關閉了主電源，當電源恢復后“自動重新啓動功能”會自動啓動機器并以斷電前用遙控器設定的模式運轉。

室內機組

將電源插頭插入插座，將撥動開關推到開的位置。

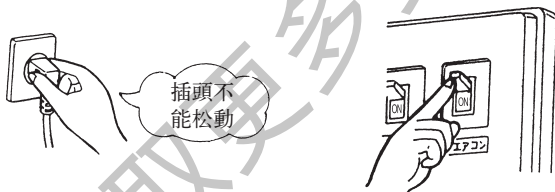

警告

須清除電源插頭上的灰塵，確實插穩固。
如果附着有灰塵或插座不良時，將有發生火災、觸電的危險。

遙控器

1 移去后蓋，裝入電池，重新裝好后蓋板。

先插入電池的負極。
檢查電池的極性是否正確。



先插入電池的負極

2 按下 復位 按鈕。

用尖細東西按下。

如果 復位 按鈕未按下，遙控器不能正常使用。



操作前的準備工作

遙控器的使用注意事項

- 信號可到達範圍是對着室內機組正面的直綫距離6米以內。
- 按下按鈕時，室內機組將發出“嗶!”或“嗶嗶!”收到信號的聲音。
如果沒此響聲，請再作一次按鈕操作。
遙控器必須小心使用。
- 如果讓它掉落地上，隨便投擲或浸了水則可能出現不能發送信號的情況。
- 不要用力擰扭遙控器，或用較強外力故意或作故意壓迫遙控器，這樣做可能會損壞其內部部件。

電 池

更換干電池的標準

信號常不易到達機組，或顯示變淡時，便請更換兩節7號鹼性電池（LR03）。

- 電池必須2節同時更換，且須屬同種電池。
- 不要使用充電式電池。
- 為防止電池漏液引起故障，在準備長期不使用時，應把電池都卸除。
- 鹼性電池壽命大約一年。
但要考慮干電池底面的建議期限(年月)，如果接近期，則必須盡早更換電池。

遙控器的安放

安放位置

- 便于操作使用且容易看見的地方。
- 幼兒的手摸不到的地方。

注 意

在有熒光燈的房間由于使用周期接通的高壓脈衝穩壓器或斷續振蕩器，有時室內機組也許接收不到來自遙控器的信號。

遙控器不能使用時(應急運轉)

當遙控器的干電池用完了電，或遙控器故障時，可利用本機上的應急運轉開關控制運轉。

- 1** 按下應急運轉開關。
每按一次應急運轉開關，機組將按應急制冷→停止的順序變化。

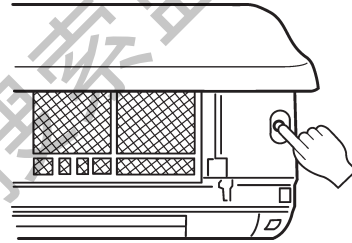

應急方式如下詳述。

溫控在試運轉的30分鐘內不起作用，而且機組處于連續運轉狀態。試運轉時風扇速度設置為高速并在30分鐘后切換到中速。

運 轉 內 容	冷氣
設 定 溫 度	24°C
風 速	中
上下風向板	自動

運轉模式將體現在室內機組的房間溫度顯示屏上。



要停止時，請按下應急運轉開關設定為停止。
每按下一次按鈕，即按照制冷→停止的順序變化。

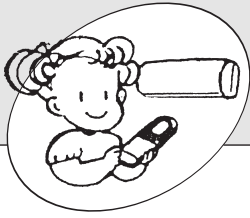

“I FEEL...” (體感...)自動運轉

在(I FEEL...(體感...))自動運轉模式下，一次操作就可自動使室內環境條件達到最佳狀態。

要選擇體感自動運轉時

按下 按鈕。

顯示 (自動運轉)時，空調機即可自動地控制為最適當的溫度。

● 要停止時

請按下 按鈕。

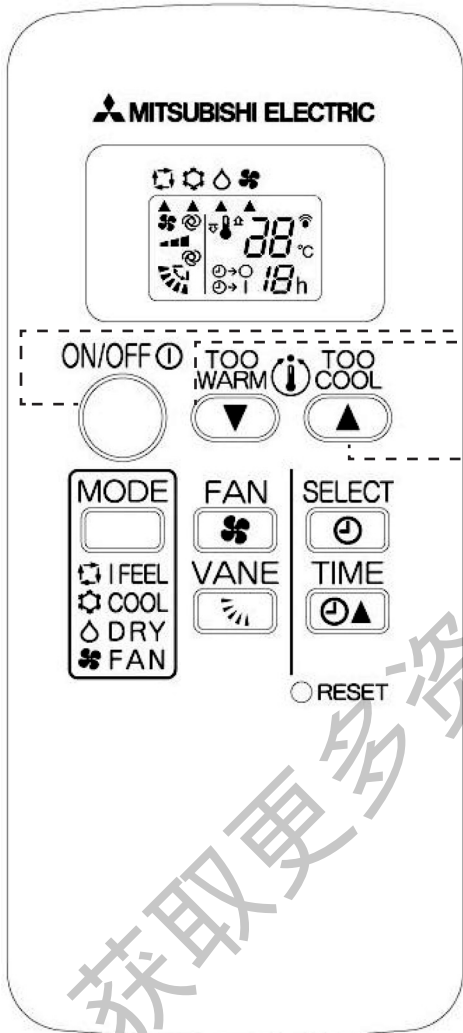

開始運轉后大約經過15分鐘，如果你感到太熱了，

要降低溫度時，可按下 按鈕。
按一次，大約下降1°C。

如果您感到太冷了，

要升高溫度時，可按下 按鈕。
按一次，大約上升1°C。

注意

不顯示自動運轉時請按 按鈕以設定自動運轉模式。

每按下一次，運轉模式即按照 (自動運轉) → (制冷) → (除濕) → (送風) 的順序變化。

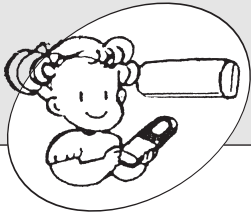

“I FEEL...” (體感...)自動運轉

自動運轉的結構

運轉模式選擇 (製冷、除濕)

開始運轉時，將根據室溫自動地設定製冷或除濕運轉，但在停機后2小時以內再運轉時，則將與上次運轉進行同樣內容的運轉。一旦設定好運轉內容后，室溫雖有變化也不受影響。

運轉內容如果不喜歡，可按下  按鈕，再選擇適當的運轉內容。

體感自動運轉內容

開始運轉時的室溫	運轉模式	目標溫度的標準(初期狀態)
大約25°C以上	製冷	大約24°C
大約13°C~25°C	除濕	—

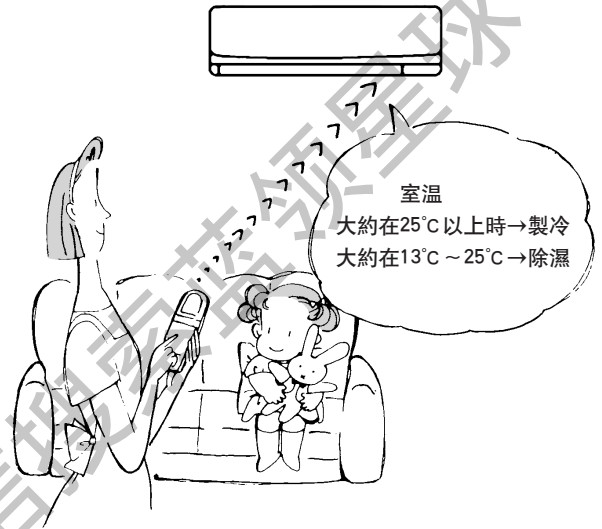

注意

- 如果室外氣溫太高，因為製冷運轉負載過大，因此，室溫便可能不能達到所設定的溫度(製冷時)。

注意

製冷：室溫高于設定溫度2°C以上時，因空調正運轉以達到目標(設定)溫度。設定溫度可能不能改變。請耐心等待直至室溫高于設定溫度2°C以內時再進行操作。

室內機組顯示

室內機組中部顯示屏指示運轉狀態。



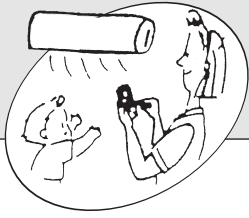

用戶自己選擇運轉模式時(製冷、除濕、送風)

選擇運轉模式，
可細微地調節溫度或風向。

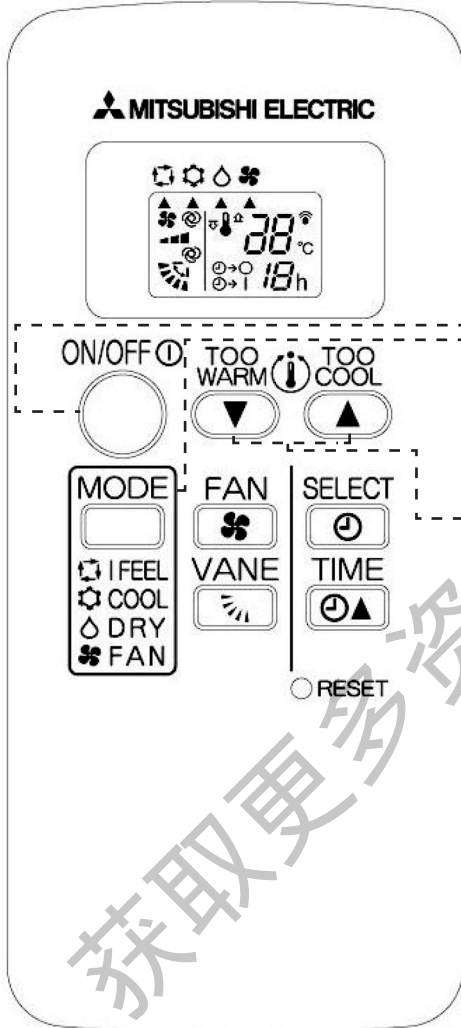

要選制冷·除濕·送風模式時

1 請按下 。

2 按下  選擇運轉模式。

每次按下按鈕，運轉模式即作  (自動運轉) →  (制冷) →  (除濕) →  (送風) 的順序變化。

● 要停止時

請按下 。

運轉模式設定以後，只要按下  按鈕，空調機即以設定模式進行運轉。

■ 要改變溫度時

■ 要降低溫度時，請按下  按鈕。

按一次，大約下降1°C。

■ 要升高溫度時，請按下  按鈕。

按一次，大約上升1°C。

除濕運轉時

■ 不能調節設定溫度。

■ 以稍低於室溫的溫度進行運轉。

注意

■ 環境溫度太高時，因為製冷運轉負載太大的關係，室內溫度可能無法達到設定的溫度。

■ 室內機組的顯示內容與“*I FEEL*”所顯示相同(請參看8頁)

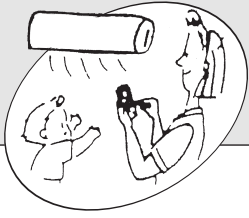

用戶自己選擇運轉模式時(製冷、除濕、送風)

使用空調須知

製冷

如何讓製冷運轉更有效率

① 關緊窗戶，放下窗簾，減小日照量。



② 在窗玻璃上貼市售的熱綫遮蔽用薄膜，也可減少進入室內的熱量。



③ 室外機組安裝在不易受太陽直射的地方。

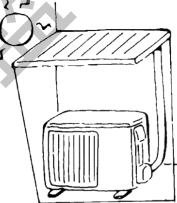

除濕

70%是人們感覺舒適的濕度分歧點

人覺得悶熱時，是因為空氣中的水蒸汽含量多，即濕度高的關係。濕度與溫度、風都有關係。一般認為人感到最舒適的濕度條件是夏季60%~75%，冬季55%~70%。







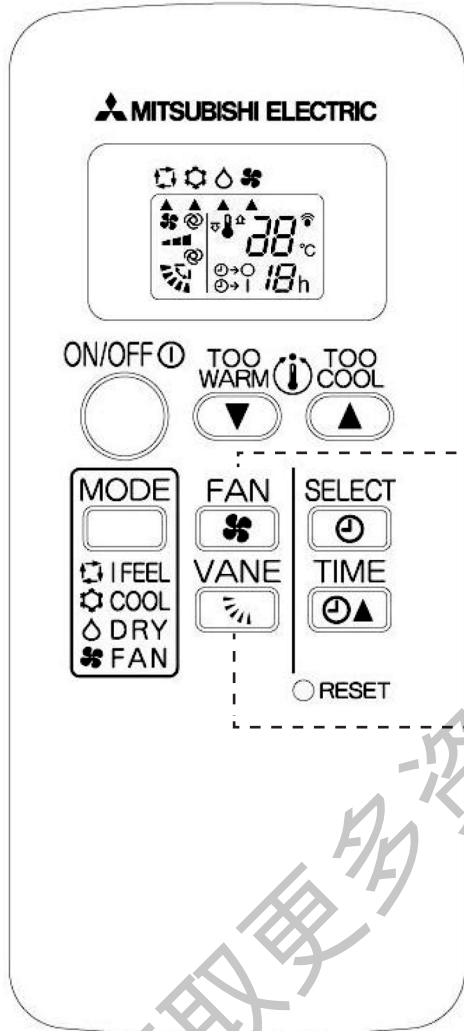

風速、風向的調節



選擇喜歡的风速與風向





要改變風速・風向時

要改變風速時，請按下  按鈕。





每次按下按鈕，即按照  (弱) →  (中) →  (強) →  (自動) 的順序改變風速。

- 要使整個房間都降溫時，請用  (強) 模式(製冷時)。
- 如果空調機的運轉聲音干擾休息，就可選擇  (低速) 檔。

要改變上下的風向時，請按下  按鈕。





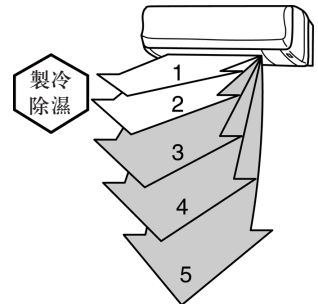

每次按下按鈕，即按照  (1) →  (2) →  (3) →  (4) →  (5) →  (擺動) →  (自動) 的順序改變上下風向。

上下風向的推薦範圍

- 平常請用  (自動)。
-  (製冷) 或  (除濕) 請用  (1)  (2) 的位置。





注意

- 除濕或製冷運轉，用  (4)， (5) 方向向下吹1個小時後，為防滴水，將自動地變成水平送風。
- 調節上下風向，請用遙控器操作控制。強制去轉動上下導風板，可能引起故障。
- 這裏的上下風向  (1) →  (2) →  (3) →  (4) →  (5) 僅為示意表示，并非表示導風板實際角度。



風速、風向的調節

自動風向

當用  按鈕把風向設定為自動  時，將根據運轉模式自動地決定上下導風板的位置進行最有效率的運轉。

(1) 製冷 • 除濕時
將以水平方向吹風。

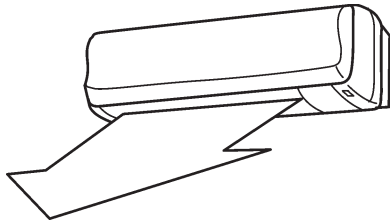

(2) 送風時
將以向下方吹風。

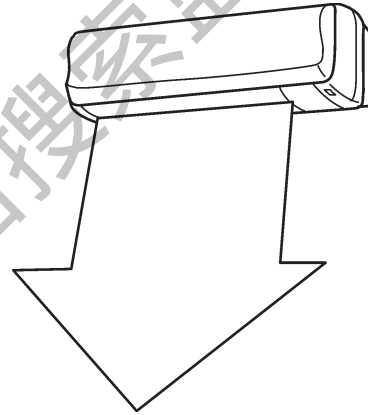

要改變左右風向時
請用手搖動左右導風板。

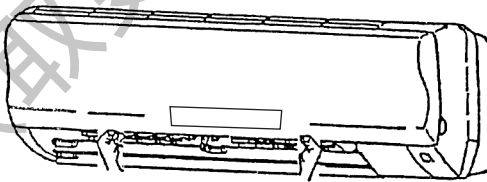

注意

調整，請在開始運轉前完成。
運轉中，因為上下導風板擺動，可能會夾住你的手指。



定時器設定(定時關/定時開)

定時器

可預設在就寢後或您回家時或起床時間、關空調器。

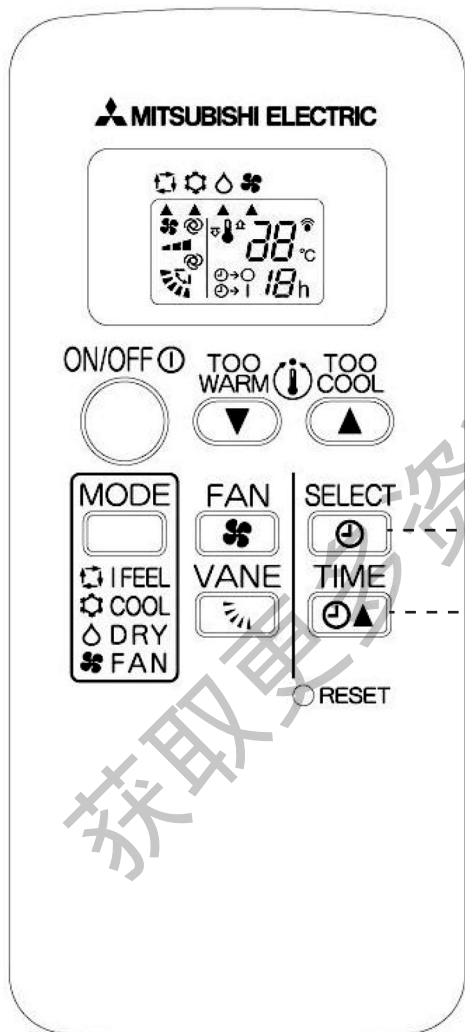

如何設置定時開

- 1 運轉時按^{SELECT}按钮。
按定時運轉按钮，“⊙→|”圖形表示。
- 2 使用按钮^{TIME}設置定時器時間。
每按一下^{TIME}按钮，時間延長1小時。

解除定時器：

- 按下^{SELECT}按钮。

如何設置定時關

- 1 運轉時按^{SELECT}按钮。
按定時運轉按钮，“⊙→○”圖形表示。
- 2 使用^{TIME}按钮設置定時器時間。
每按一下^{TIME}按钮，時間延長1小時。

解除定時器：

- 按下^{SELECT}按钮。

注意

- 定時開、定時關不能同時設定。
- 設定時間能以1小時為單位。
- 定時器設定中及設定后按^{SELECT}按钮後，定時器設定取消，所有的運行停止。
- 設定時間最大為12小時。
- 設定定時運轉後，運轉指示燈亮。

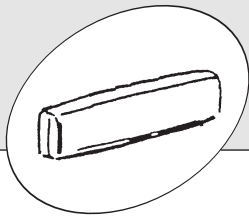

長期不使用時

長期不使用時

1 實施風扇運轉3~4小時，讓空調機內完全干燥。

- 要進行風扇運轉時，請設定為製冷運行模式并選擇最高設定溫度。

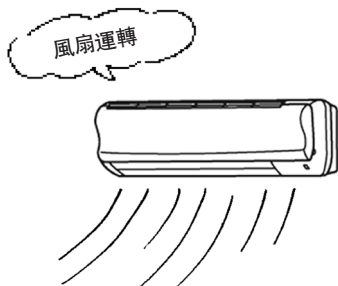

2 關掉電源開關，然後拔掉電源綫插頭。

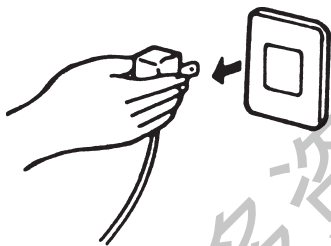

⚠ 警告

長期不使用機器時，應拔下電源插頭。
因為可能堆積灰塵而引起火災。

3 取出遙控器中的電池。

要再開始使用時

1 清掃茶精清新網，并裝回本機。 (清掃的方法，請參看18頁)

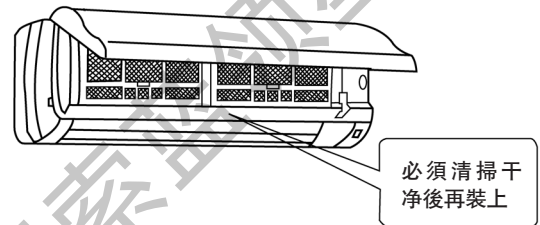

2 室內及室外機組的進風口、排風口，須確認是否被遮蔽了。

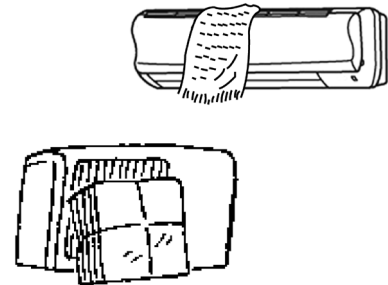

3 確認接地綫是否牢固。

⚠ 警告

要接地綫。

- 地綫不可接在煤氣管、自來水管、避雷針、電話綫上面。
- 若無接地綫或不按要求接地綫，可能有觸電危險。



室內機外觀的清掃方法

清掃之前

關掉電源開關，拔下電源插頭。

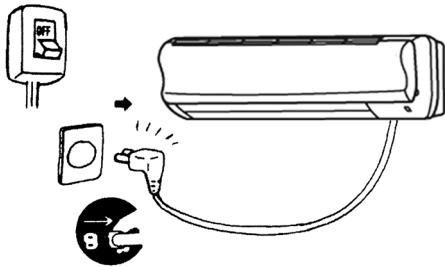

警告

清掃時，必須停止運轉，拔下電源插頭并關掉電源開關。
因為運轉中，高速旋轉中的風葉，可能造成人身傷害。

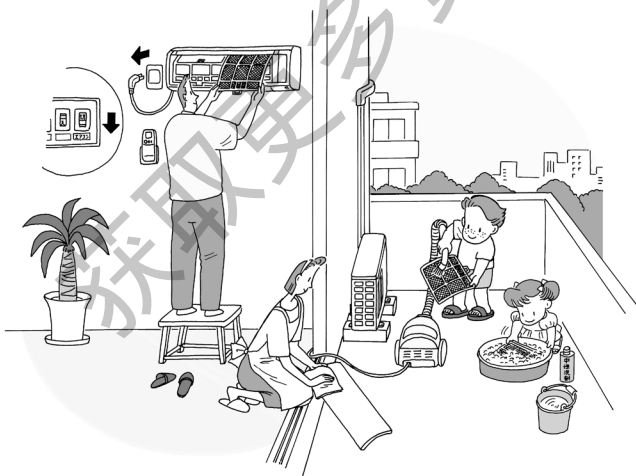

電源插頭的清掃

清掃電源插頭上的灰塵。

室內機 / 遙控器的清掃

用柔軟的布擦拭干淨，汽油，揮發性油，稀釋劑，研磨粉，洗滌劑會損壞產品，所以請不要使用。

拆下并清潔前面板

- 1 用柔軟的布擦拭或水洗。
水洗後用柔軟的布擦干淨水分并陰干。
- 2 滯留在顯示部的水分應從反面用柔軟的布吸取水分。
- 3 頑固污漬可以用軟布沾取中性清潔劑擦拭。
- 4 嚴禁使用汽油，揮發油，混合溶劑，磨擦粉，消毒劑和洗滌精，請勿用刷子或百潔布之類堅硬接觸面的工具清洗。
- 5 請勿長時間(2小時以上)置于熱水中或置于直射陽光及取暖器作用範圍內，否則會導致前面板變形及變色。

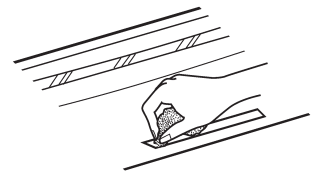

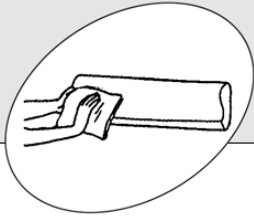

前面板的拆下和安裝方法

前面板的拆下

- 1 用雙手抓住前面板，水平提起并握住鉸鏈部向前拉出。

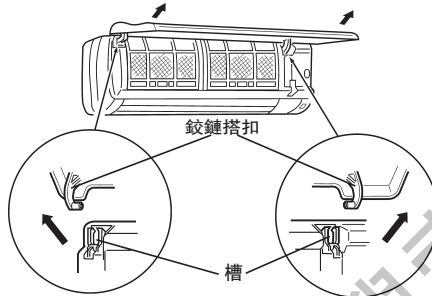

- 2 不要强行抽出前面板，不要掉落，否則會造成前面板破損。

- 3 拆裝前面板時，不要站在不穩定臺面上，否則有可能翻倒受傷。

前面板的安裝

- 1 用兩手握住前面板的兩端，把前面板大致水平放置，再把鉸鏈部(下圖)放入室內機最上部的槽中。(左右鉸鏈搭扣插入，直至聽到“咔嚓”聲為止)。

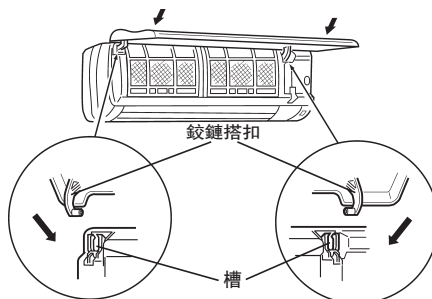

- 2 用雙手握住前面板的兩端并關上前面板，再用手按一下下圖箭頭表示的三個部位，至此前面板就安裝完畢。

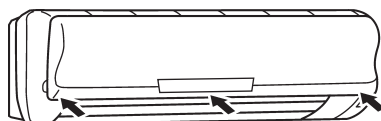



茶精清新網的清掃

清掃時，只可將前面板打開到如圖示位置，不要打開到水平位置。水平位置時，前面板將會脫落下來。

茶精清新網的清掃(二星期一次為標準)

1 卸下茶精清新網。

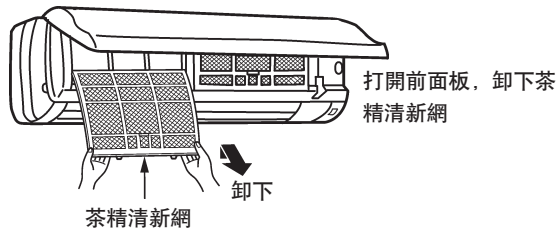

警告

拆卸茶精清新網時，請注意別碰到室內機組的金屬部分，因為有被刮傷的可能。

2 卸下的茶精清新網，可用吸塵器清掃或用水洗滌干净。

- 如果茶精清新網太髒了，可用加入中性洗滌劑的溫水溶液洗刷。
- 禁止用熱水(大約50°C以上)清洗，以免變形。

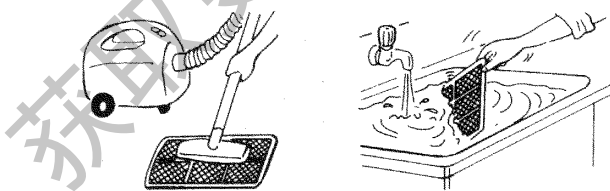

3 用水洗滌過後，應待陰干後才能使用。

- 茶精清新網，禁止利用直射陽光干燥或用火烘干。

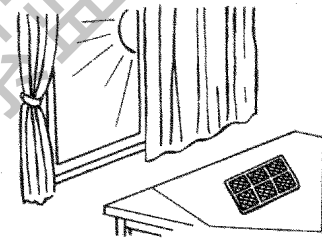

4 安裝茶精清新網。

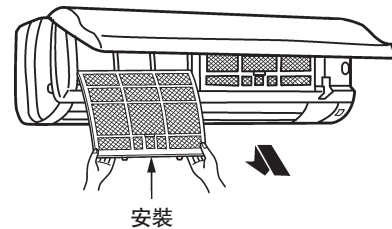

茶精清新網的作用：綠茶成份的茶精分解，清除香烟、汗水等的臭味，更能抑制細菌的產生，成長，繁殖。（依照日本紡織檢查協會，纖維產品的定量抗菌性試驗方法。）

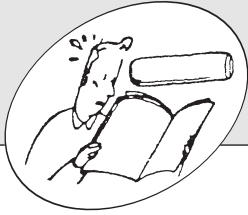

在請維修人員之前，請再次檢查以下項目

完全不運轉？



進行下一步檢查！

- 1 電源開關或保險絲是否切斷了。

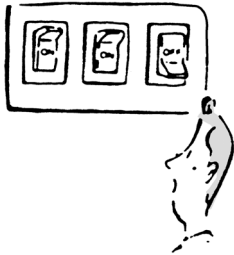

- 2 是否設定着「定時開狀態」。



製冷運轉無法制冷？



進行下一步檢查！

- 1 溫度調節是否適當。



- 2 空氣過濾網是否髒了。



- 3 室外機組的排風口、吸氣口是否被遮蔽了。

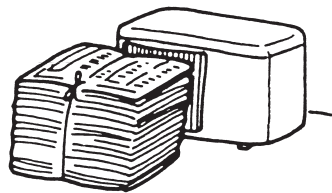

遙控器不顯示，遙控器不靠近機器便不起作用。
遙控器信號不易到達機組，並且顯示變淡時。

- 1 干電池是否沒有電了。

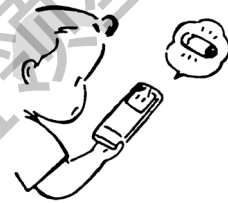

- 2 干電池的(+)、(-)電極是否裝反了。

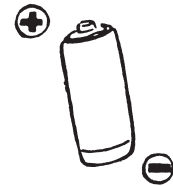

發生停電時？⇒ 進行下一步檢查！

空調機處于停止狀態。通電后，請再按運轉/停止按鈕。

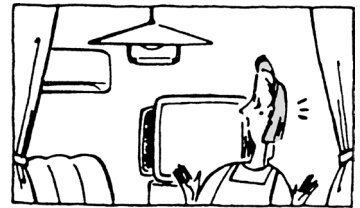

檢查上述各項目後，如果問題仍不能解決時，請立即停止使用，并與機器的出售店或技術服務中心進行聯系。

在要求維修之前，請注意下列情況。

- 在使用電子式熒光燈的房間裏，有可能不能接收遙控信號。
- 在無線電廣播電波弱的地方，可能在空調機運轉着的時候，收聽短波廣播會有噪聲。
- 打雷時，請停止運轉并拔下電源插頭或關掉電源開關器。否則，可能有損傷空調電氣部件的危險。



當您認為「發生故障？」時

是否出了故障？

答案(不是異常)

雖然，重新開機
運轉，可是室外機大約
3分鐘內并不啓動。

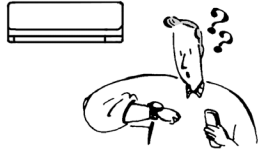

- 這是根據微型電腦的指示以保護空調機的現象，請放心等待。

發出“嘩噓！”的聲音。

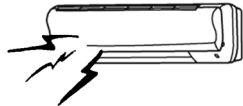

- 因溫度變化，前面板發生膨脹、收縮引起的摩擦聲音。

房間裏有臭味兒。

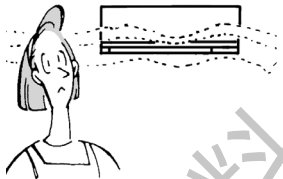

- 這是空調機吸取牆壁、地毯、家具、衣服所含霉味而吹出到空氣中的現象。

除濕(△)運轉中，
風扇停止了。

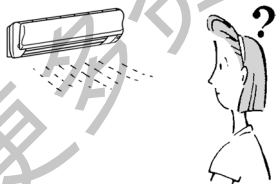

- 附在室內機組熱交換器上的水分再蒸發時，濕度便會上升。爲了抑制此現象，當室溫已充分下降時，室內機組的送風運轉便會自行停下來。

可聽到象流水
的聲音。



- 這是空調機內部的制冷劑在流動的聲音。
- 附着在熱交換器上的水滴匯流聲。

運轉中，
自行改變風向。

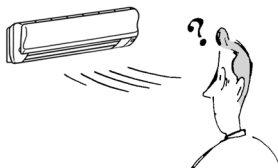

- 除濕或製冷運轉中，向下送風一個小時之后，爲防滴水而自動將上下導風板調整到水平位置繼續送風。



當您認為「發生故障？」時

是否出了故障?

答案(不是異常)

室內機發出“布
噓”聲音。



■ 這是空調機啓動或停止冷媒流動的聲音。

室外機組有漏水現象。

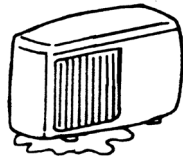

■ 冷氣運轉中，管道或管道接頭部分將因冷卻而引起水份冷凝。

可從室內機組聽到“咯嗒
咯嗒”聲音。



■ 這是風扇或壓縮機開關正在切換（接通/斷開）的聲音。

房間不能充分製冷。

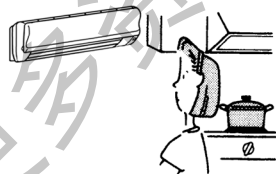

- 排風扇或液化竈具使用時，製冷負荷加重，導致製冷效果不足。
- 室外氣溫太高時，製冷效果不足。

運轉中，室內機出風口吹
出霧氣。

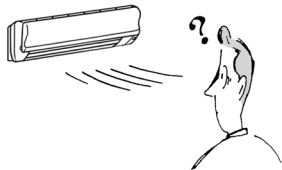

■ 空氣中的水份遇到從室內機出風口裏吹出的冷風而迅速凝結成霧氣所至。



安裝、移機、檢查

安裝場所

禁止安裝在如下的場所。

- 有可能洩漏可燃性氣體的地方。

⚠ 注意

- 禁止安裝在有可能洩漏可燃性氣體的地方。因為萬一洩漏的氣體聚集在機組周圍，將有引起爆炸的可能。
- 在電波信號較弱的地方，使用無線接受設備（電視機/收音機等）如發生信號明顯有干擾時，建議另購信號放大器，以提高接受質量。

- 有很多機油的地方。
- 海邊等鹽份多的地方。
- 溫泉等會產生硫化氣體的地方。
- 飛散油滴，聚集油煙的地方。
- 周圍有高频機器或無線電設備/無繩電話或手機。

電氣施工

- 電源請一定使用空調機專用的綫路。
- 電源開關須採用規定的容量。

⚠ 警告

- 用戶不可自己安裝。安裝不妥，將可能發生火災、觸電、機組掉落傷人，或漏水等問題。
- 禁止在電源綫中途引綫，或用延長電綫，或使用多孔插座。接電不妥，可能因接觸不良，絕緣不良或超過電流容量而發生火災或觸電等事故。請洽詢購買機器的出售店或專業者為您服務。

⚠ 注意

- 空調插座應連接有專門接地綫，地綫切勿接到煤氣管、自來水管、避雷針導綫、電話接地綫上。
- 如果沒有接地綫或地綫沒有連接好，可能引起觸電事故。
- 在使用前請務必確認是否有接地綫或接地綫是否按要​​求連接。
- 安裝空調機時有些地方（潮濕的地方），須裝漏電保護器。不裝漏電保護器，可能有觸電的危險。

電視機或收音機等無線接受設備需距離室外機3m以上，如這樣還有明顯信號干擾時，可再加長相互間距離，以提高接受質量。

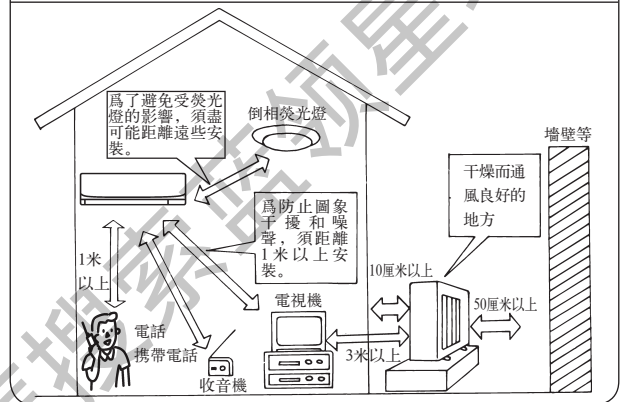

檢查維修

- 空調機用過幾年之後，因內部骯髒，性能將減低。
- 因使用狀況而可能發生臭味，或因堆積塵垢而造成冷凝水的排水不良。
- 與普通的檢查維修不同，最好請專門技術人員為您服務。請與本空調器的出售店或技術服務中心聯系。

運轉噪聲問題也須考慮

- 室外機組的排風口附近不可堆置東西。因為將會減低機器效能也可能增大運轉噪聲。
- 運轉作用中，如果發生異常聲，即請與本空調器的出售店或技術服務中心聯系。

要移機時

- 因增改建房間，遷居而須拆卸下空調機及再安裝時，必須找專門技術人員為您服務。

⚠ 注意

用戶請不要自己修理或移設空調機。如果處理不當，便有發生火災、觸電、機組掉落傷人、漏水等的危險。請與本空調機的出售店或技術服務中心聯系。

如果電源軟綫損壞，必須使用專用軟綫或從制造廠或維修部門買到的專用組件來更換。

此外，如果還有不明白的地方，即請找機器的出售店聯系。

技術性能表

型號	MSD-CF09VB-H1	MSD-CF12VB-H1
防觸電保護	I類	
電源	220V~50Hz	
制冷量(W)	2800	3650
制冷輸入功率(W)	890	1160
制冷輸入電流(A)	4.2	5.5
循環風量(m ³ /h)	553	548
加液量(g)	750	1080
室內噪聲(dB(A))制冷時(高速檔/低速檔)	40/26	40/29
室外噪聲(dB(A))	45	46
室內淨質量(kg)	10	10
室外淨質量(kg)	27	37
室內尺寸 高×長×寬(mm)	278×815×238	
室外尺寸 高×長×寬(mm)	550×800×285	
標準配管 長(m)	4	
排氣側允許工作過壓(MPa)	4.15	
吸氣側允許工作過壓(MPa)	1.64	
熱交換器的最大工作壓力(MPa)	4.71	
儲罐允許工作壓力(MPa)	1.94	

注：① 本產品適用環境溫度範圍：

		室內	室外
制冷	上限	32°C 干球 23°C 濕球	43°C 干球 —
	下限	21°C 干球 15°C 濕球	21°C 干球 —

② 噪音值是表示出廠前全消音試驗室環境下測得數據。

③ 產品執行：GB/T7725 GB4706-32-2004 GB4343-1-2003

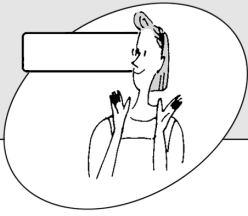

SAFETY PRECAUTIONS

- Be sure to read these "safety precautions" before use.
- Since these cautionary items shown here are important for safety, be sure to observe them. Marks and their meanings are as shown below.

Meanings of symbols used in this manual are as shown below.

	Be sure not to do.
	Be sure to follow the instruction.
	Be sure to apply grounding.
	Be sure to disconnect the power plug from the power outlet.
	Never step on the indoor/outdoor unit and do not put anything on them.
	Danger of electric shock, be careful.
	Never insert your finger or stick etc.

- After reading this manual, keep it together with the installation manual in handy place for easy reference.

Do not use the air conditioner in an environment where the volatile, corrosive or flammable chemical is in use.

- When the volatile, corrosive, or flammable chemical (e.g. dimethylbenzene, banana oil, carbinol etc.) is in use, be sure not to use the air conditioner.
- When the paint is wet, be sure to open the window to keep ventilation. To use the air conditioner after the dilution gas has been eliminated completely.
- Otherwise the unit may be corroded, or deformed, even it may cause a fire.



⚠ WARNING

Do not connect using branched outlet or an extension cord, and do not attach many loads to one electric outlet.

- A fire or electric shock may result from poor contact, poor insulation, exceeding the permissible current, etc.

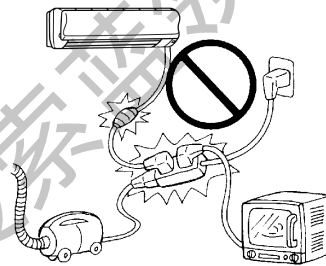

Remove dirt from the power plug and securely insert into the outlet.

- If dirt adheres to the plug or insertion is incomplete, it may cause a fire or electric shock.

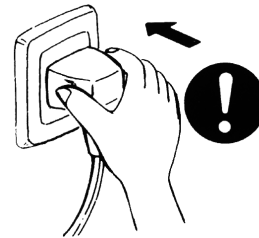

Do not scratch or process the power cord, etc.

- Do not put heavy object on the power cord, do not heat it, and do not process it. The cord may be damaged and it may cause a fire or electric shock.

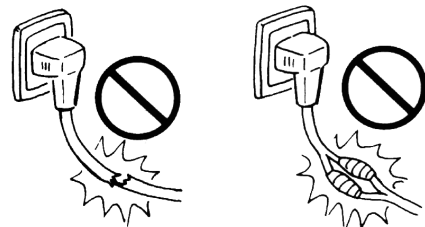

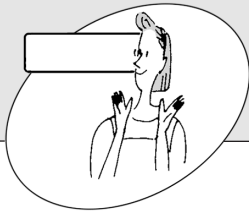

SAFETY PRECAUTIONS

⚠ WARNING

Do not disconnect/connect the power plug during operation.

- This may cause a fire due to sparks, etc.

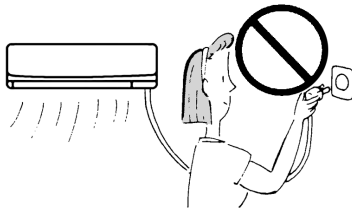

Do not clean the air conditioner with water.

- Water may enter the unit and degrade the insulation. It may cause an electric shock.

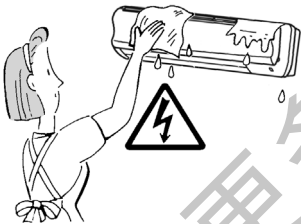

When an abnormality (smell of burning, etc.) occurs, stop the air conditioner, and disconnect the power plug or turn off the breaker.

- If the unit continues to be operated in an abnormal condition, it may cause a fire, trouble, etc. In this case, consult your dealer.



Do not insert your finger or stick, etc. into the air inlet/air outlet.

- Since the fan rotates at high speed, this may cause an injury.



Repair or relocation should not be done by the customer.

- If this is done incorrectly, it may cause a fire, electric shock, injury by dropping of the unit, water leakage, etc. Consult your dealer or service center.

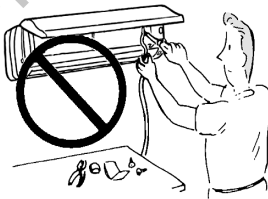

The customer should not install this unit.

- If this is done incorrectly, it may cause a fire, electric shock, injury by dropping of the unit, water leakage, etc. Consult your dealer or service center.

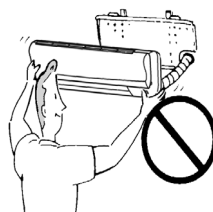

Do not pull the power cord.

- Hold the power plug to disconnect it. The core wire of the power cord may be disconnected and it may cause a fire.

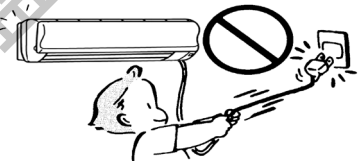

When the unit is to be cleaned, switch off, and disconnect the power plug or turn off the breaker.

- Since the fan rotates at high speed during operation, it may cause an injury.

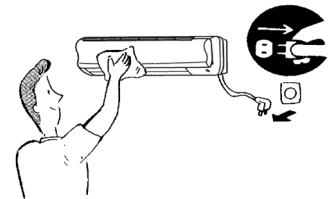

Do not operate switches with wet hands.

- It may cause an electric shock.





SAFETY PRECAUTIONS

⚠ WARNING

Do not expose the skin to cool air directly for long time.

- This could damage your health.

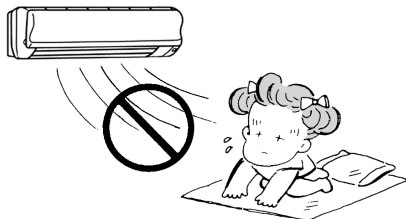

Do not step onto an unstable bench when attaching/detaching the panel.

- It may cause an injury, etc. by falling down.



Do not apply an insecticide or flammable spray.

- It may cause a fire or deformation of the cabinet.

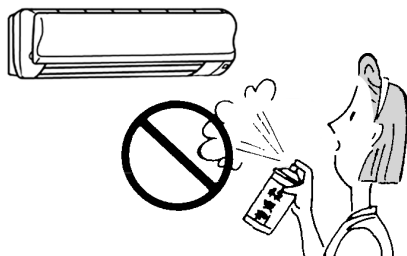

Ventilate well when used together with a stove, etc.

- An oxygen shortage may occur.

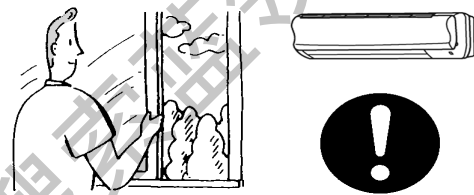

When the air filter is to be removed, do not touch the metal parts of the indoor unit.

- It may cause an injury.

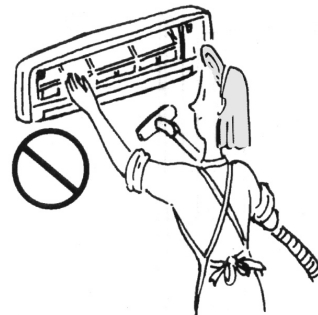

Do not put a stove, etc. where is exposed to direct air flow.

- It may cause imperfect combustion.

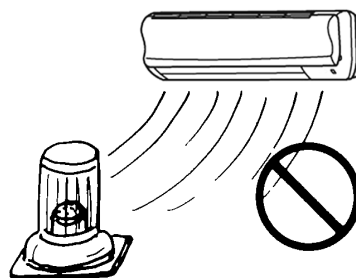



SAFETY PRECAUTIONS

⚠ WARNING

When the unit is not going to be used for a long time, disconnect the power plug or turn off the breaker.

- If not, dirt may collect and cause a fire.

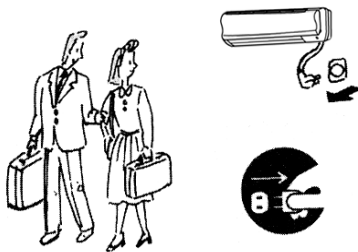

Do not step on the indoor/outdoor unit and do not put anything on it.

- It may cause an injury through dropping or falling down.

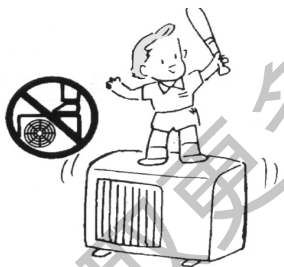

Do not leave on installation stand which is damaged.

- The unit may drop or fall down and cause an injury.

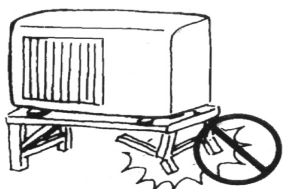

- Consult your dealer or service center for installing the air conditioner.

Apply grounding.

- Air conditioner socket must apply grounding by a special grounding wire. Do not connect the grounding wire to a gas pipe, water pipe, lightning rod or grounding wire of a telephone.
- If a grounding wire is absent or incorrect, it may cause an electric shock.
- Be sure whether there is a grounding wire and whether it is connected correctly.



Install an earth leakage breaker depending on the place where the air conditioner is to be installed (humid place, etc..)

- If the earth leakage breaker is not installed, it may cause an electric shock.



Do not install the unit where flammable or corrosive gas could leak.

- If gas leaks or collects around the unit, it may cause an explosion, or the unit may be damaged.



Drain water should be fully drained.

- If the drainage route is incomplete, water may drop from the unit, it may wet and spoil furniture.

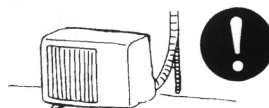

⚠ CAUTION

Do not operate for a long time in high humidity, e.g. leaving a door or window open.

- In the cooling mode, if it is operated in a room with high humidity (80% r.h. or more) for a long time, water condensed in the air conditioner may drop and may wet and spoil furniture, etc.

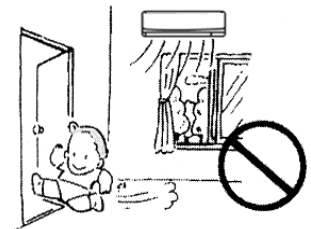

Do not use for special purposes.

- Do not use this air conditioner to preserve precision devices, food, animals, plants and art objects. It may cause deterioration of quality, etc.

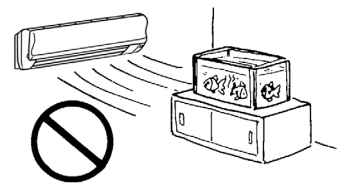

Do not put a pet or house plant where will be exposed to direct air flow.

- This could injure the pet or plant.

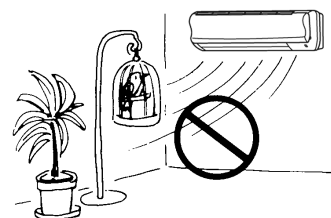

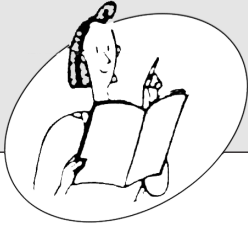

NAME OF EACH PART

Indoor unit

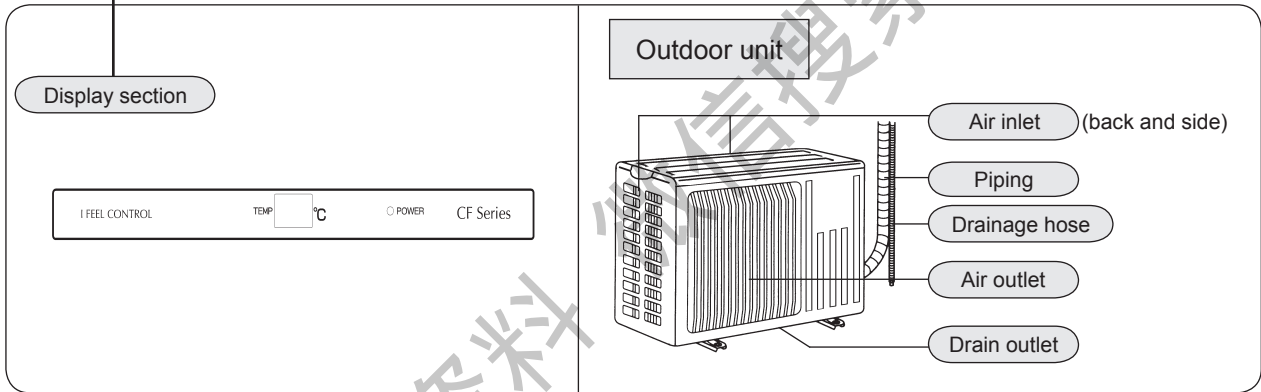
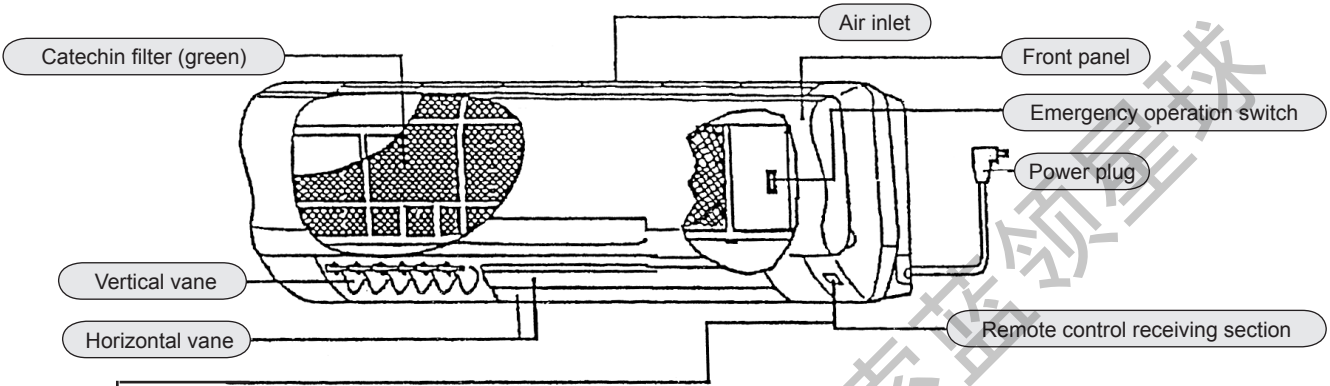

Remote controller

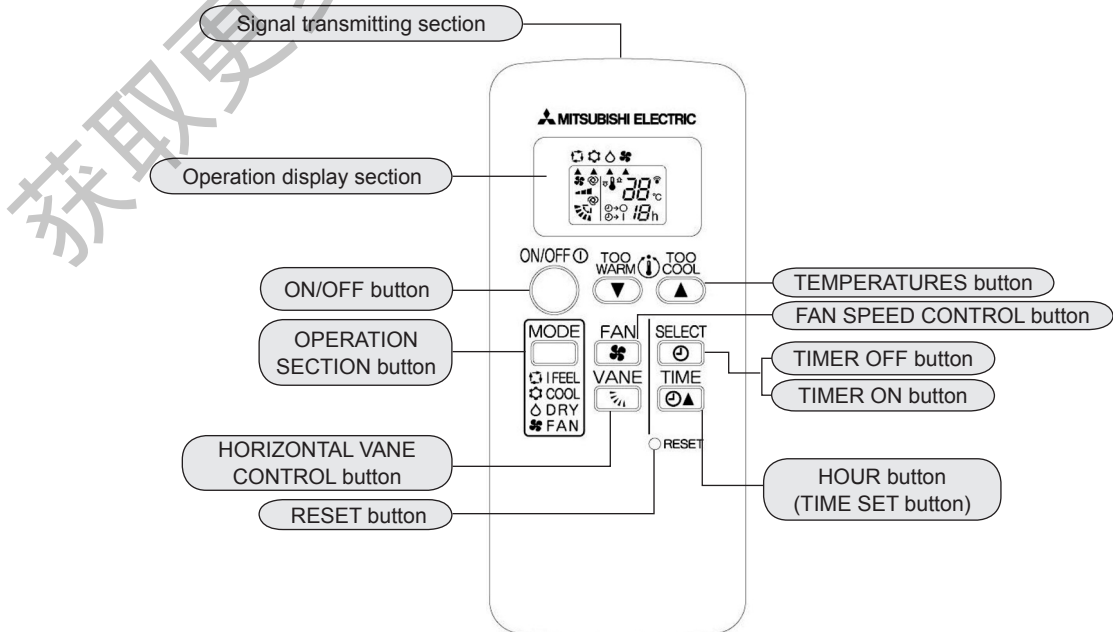



PREPARATION BEFORE OPERATION

AUTO RESTART FUNCTION

■ This unit has AUTO RESTART FUNCTION, but when it is leaving factory, this function is set off. If you need this AUTO RESTART FUNCTION, please contact with the Service Center. Because the configuration of the unit should be changed.

AUTO RESTART FUNCTION is...

The operation mode, set temperature and fan speed will be memorized when using the remote controller to control the indoor unit. If a power failure occurs during operation, the AUTO RESTART FUNCTION may start the unit automatically and run it at the mode set by the remote controller before the power is off.

INDOOR UNIT

■ Insert the power plug into the power outlet and turn the breaker on.



! WARNING

Remove dirt from the power plug and insert it securely. If dirt adheres to the plug or insertion is incomplete, it may cause a fire or electric shock.

REMOTE CONTROLLER

1 Remove the back lid and insert batteries, and then reattach the front lid.

Do not confuse (+) and (-).



Insert the cathode of the batteries in the first.

2 Press the RESET button.

Press it using a thin stick.

■ If the RESET button is not pressed, the remote controller may not operate correctly.



PREPARATION BEFORE OPERATION

Notes for using the remote controller

- The range that the signal can reach is about 6m when pointed at the front of the indoor unit.
- When the button is pressed, one or two beeps will be heard from the indoor unit. If no sound is heard, operate again. Use the remote controller carefully.
- If it is dropped, thrown or gets wet, it may not operate.
- Do not wring or press the remote controller, it may cause the components inside the remote controller damage.

Batteries

Reference for replacing batteries

When the signal does not operate the indoor unit, or the display becomes dim, replace the batteries with new alkaline batteries (LR03)

- Replace 2 batteries with new batteries of the same type. Do not use rechargeable batteries.
- To prevent from liquid leakage, take out all batteries when the remote controller is not going to be used for a long time.
- The service life of an alkaline battery is about 1 year. However, since the recommended usable time limit is indicated (month/year) on the bottom of the battery, a battery the time limit of which is approaching may become exhausted sooner.

Laying the remote controller

Laying places

- The places where it is easy to operate and easily visible.
- The places where children can not touch.

NOTE

In rooms where inverter type fluorescent lamps are used, the signal from the wireless remote controller not be received.

WHEN THE REMOTE CONTROLLER CANNOT BE USED (Emergency operation)

When the batteries of the remote controller run out or remote controller malfunctions, Emergency operation can be done using the Emergency operation switch.

1 Press the Emergency operation switch.

Each time the switch is pressed, the unit alternates between the Emergency COOL mode and STOP mode.

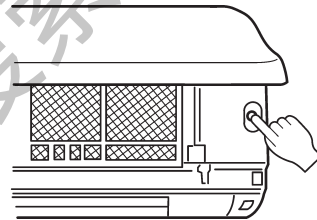

Details of operation are as shown below. However, the temperature control does not work for about 30 minutes at first and the unit is set to the continuous operation mode with the fan speed set to "Medium", 30 minutes later:

Details of operation	Cool
Set temperature	24°C
Fan speed	Medium
Horizontal vane	Auto

The operation mode is indicated by the room temperature on the indoor unit as following figures.

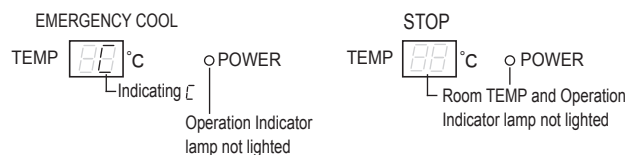

To stop the Emergency operation, press the Emergency operation switch.

Each time the switch is pressed, the unit alternates between the Emergency COOL mode and STOP mode.

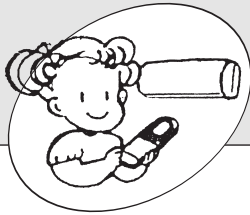

"I FEEL..." AUTO-OPERATION

With the "I FEEL..." auto-operation mode, the optimum room condition can be set automatically by one-touch operation.

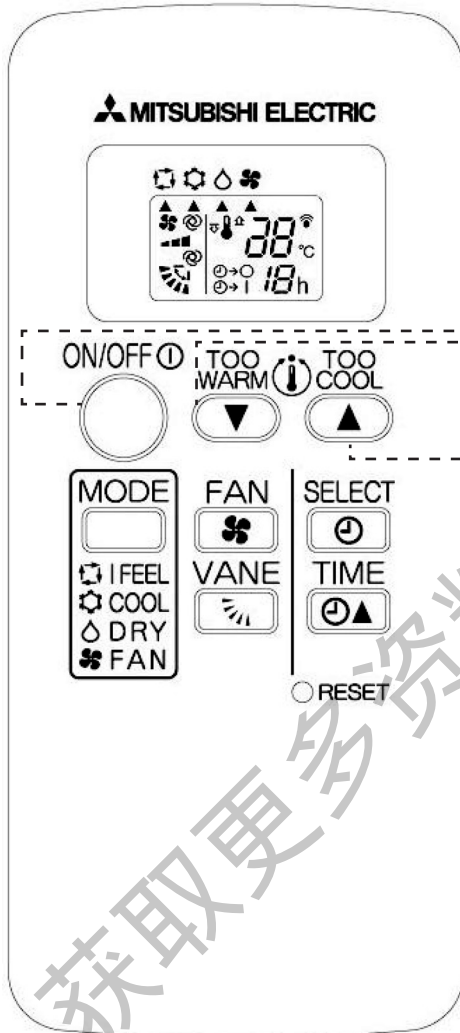

TO SELECT "I FEEL..." AUTO-OPERATION

Press the button.

When the "I FEEL..." is displayed, the air conditioner is automatically controlled at the optimum temperature.

● To stop operation

Press the button.

When about 15 min. passes after operation start. If you feel slightly warm,

Press the button to lower the temperature. One press lowers the temperature by about 1°C.

If you feel slightly cool,

Press the button to raise the temperature. One press raises the temperature by about 1°C.

NOTE

When auto-operation is not displayed, press the button to set to the "I FEEL..." auto-operation mode.

Each time the button is pressed, the operation mode is changed in sequence, from (I FEEL...), (COOL), (DRY) to (FAN).

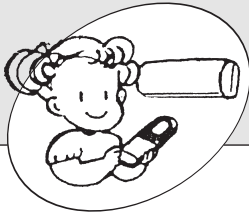

"I FEEL..." AUTO-OPERATION

DESCRIPTION OF "I FEEL..." MODE

Details of operation

According to the room temperature when the operation starts, the operation mode is automatically selected between COOL and DRY. However, when operation is started again within 2 hours after the operation is stopped, the same operation mode before it is stopped is selected. The operation mode selected first is not changed even if the room temperature changes. If the operation mode does not match the room condition, select the requires operation mode by pressing the  button.

Details of auto-operation

Room temperature when started	Operation mode	Target temperature (initial state)
About 25°C or higher	COOL	About 24°C
About 13°C ~ 25°C	DRY	--

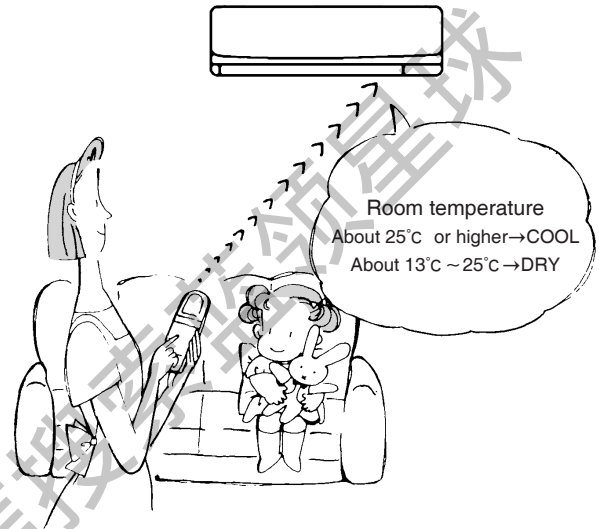

NOTE

COOL: When the room temperature is 2°C higher than the set temperature, the set temperature may not be changed since the air conditioner is operating to reach the target (set) temperature. In this case, please wait until the room temperature drops to within 2°C of the set temperature and then change the set temperature.

Details of display on the indoor unit.

The middle indicator of the indoor unit indicates the operation state.

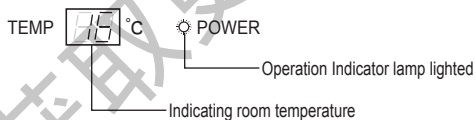

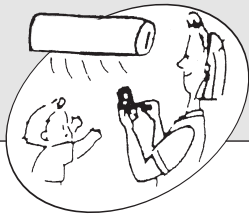

MANUAL OPERATION (COOL, DRY, FAN)

With this operation mode, the temperature and airflow direction can be finely adjusted by selecting the operation mode.

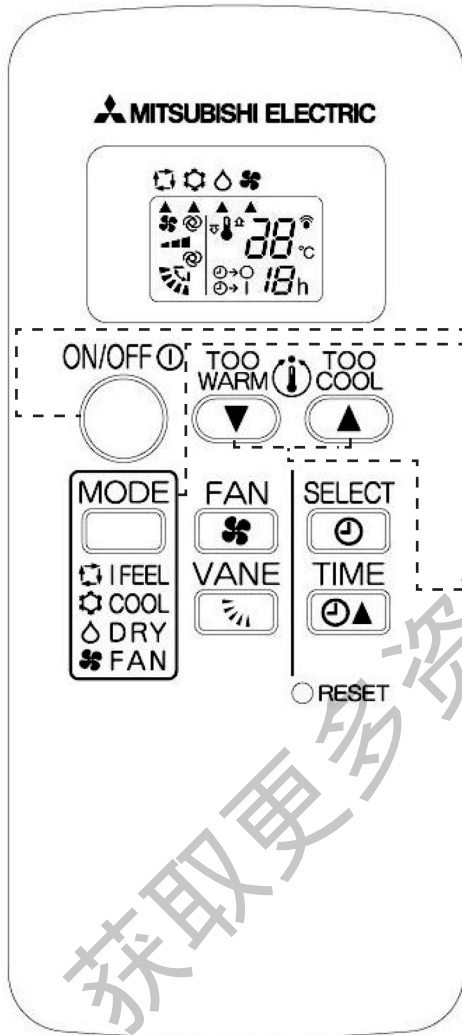

To select the "COOL", "DRY" OR "FAN" MODE

1 Press the button.

2 Select the operation mode by pressing the button. Each time the button is pressed, the operation mode is changed in sequence, from (I FEEL...), (COOL), (DRY) to (FAN).

● To stop operation:

Press the button. After the operation mode is set once, the operation starts in the mode set previously from the next time by simply pressing the button.

■ When the set temperature is to be changed:

■ Press the button to lower the temperature. One press lowers the temperature by about 1°C .

■ Press the button to raise the temperature. One press raises the temperature by about 1°C .

IN "DRY" OPERATION

- The temperature control (temperature setting) cannot be done.
- The room temperature is slightly lowered in this operation mode.

■ The details displayed on the indoor unit are the same as those in the "I FEEL...". See page31.

NOTE

- When the ambient temperature is too high, the room temperature may not reach the set temperature since the unit operates to cool at high load.

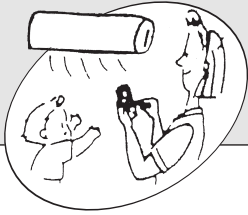

MANUAL OPERATION (COOL, DRY, FAN)

CONVENIENT INFORMATION

COOL For effective cooling

① Close the windows and pull down blinds. Sunshine is reduced and cooling efficiency increases.



② Paste a heat shield film (generally available) on the window. Heat entering the room is reduced.



③ Block the outdoor unit from direct sunlight. This saves energy.

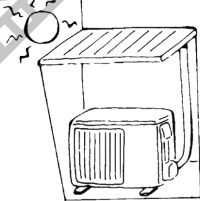

DRY The humidity at which humans feel comfortable

When air contains too much moisture, humans feel clammy. Humidity is related with temperature and wind. The humidity at which humans feel comfortable is 60% ~ 75% RH in summer, 55% ~ 70% RH in winter.





AIR FLOW VELOCITY AND DIRECTION ADJUSTMENT

AIR FLOW velocity and direction can be selected as required.

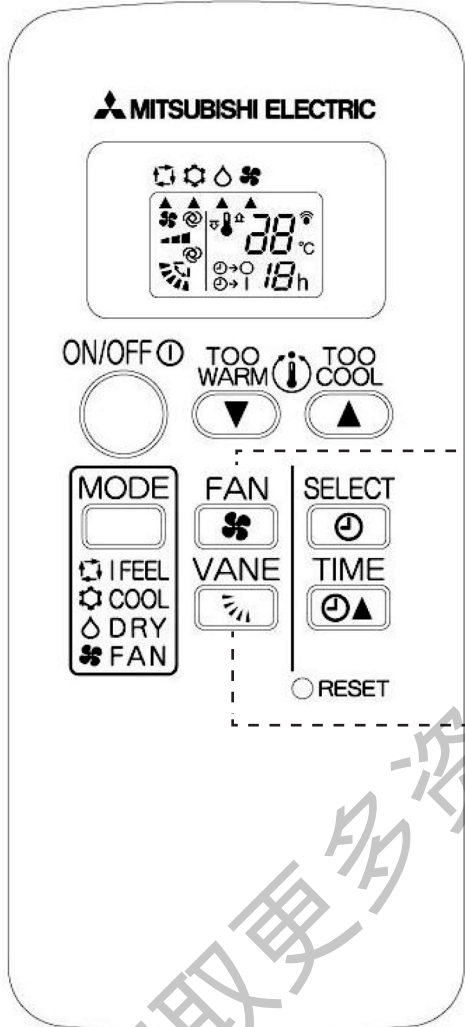

HOW TO CHANGE THE AIR FLOW VELOCITY AND DIRECTION

■ To change the AIR FLOW velocity, press the button.

Each time the button is pressed, fan speed is changed in sequence, from [Lo] [Med] [Hi] [AUTO].

- To cool the whole room, use the (Hi) mode.
- If the sound of the air conditioner operation disturbs your sleep, use the (Lo) mode.

■ To change the AIR FLOW blowing direction vertically, press the button.

Each time the button is pressed, angle of horizontal vane is changed in sequence, from (1) (2) (3) (4) (5) (SWING) (AUTO).

RECOMMENDED HORIZONTAL VANE RANGE

- Use in the (AUTO) position usually.
- Use (1) or (2) position (COOL, DRY) when adjusting as required.

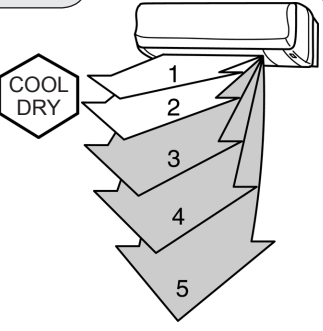

NOTE

- In the cooling or drying operation, when the air conditioner is operated with AIR FLOW blowing down (4) or (5) for 1 hour, the AIR FLOW direction is automatically set to level to prevent condensed water from dropping.
- Adjust the vertical AIR FLOW direction using the remote controller. If the horizontal vane are moved manually, it may cause trouble.
- The direction of AIR FLOW at this place (1) (2) (3) (4) (5) just a sketch map and it does not indicate the actual angle of the vane.



AIR FLOW VELOCITY AND DIRECTION ADJUSTMENT

AUTO AIR FLOW DIRECTION

When the AUTO mode is selected with the  button, the position of the horizontal vane are automatically set to correspond to the operation mode to perform effective operation.

(1) COOL, DRY

The AIR FLOW blows level.

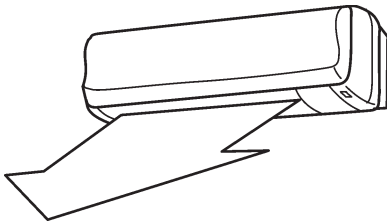

(2) FAN

The AIR FLOW blows down.

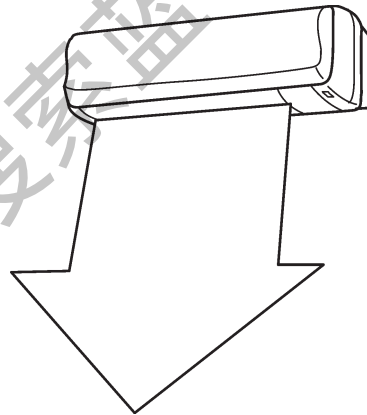

■ To change the horizontal direction of the AIR FLOW move the vertical vanes manually.

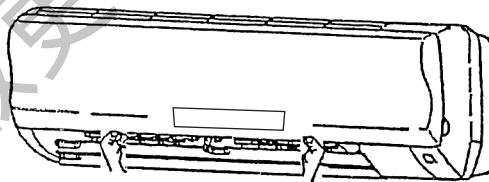

NOTE

- Adjust the vanes before starting operation.
- Since the horizontal vane move automatically during operation, your fingers may be caught.





TIMER OPERATION (OFF TIMER ON TIMER)

TIMER

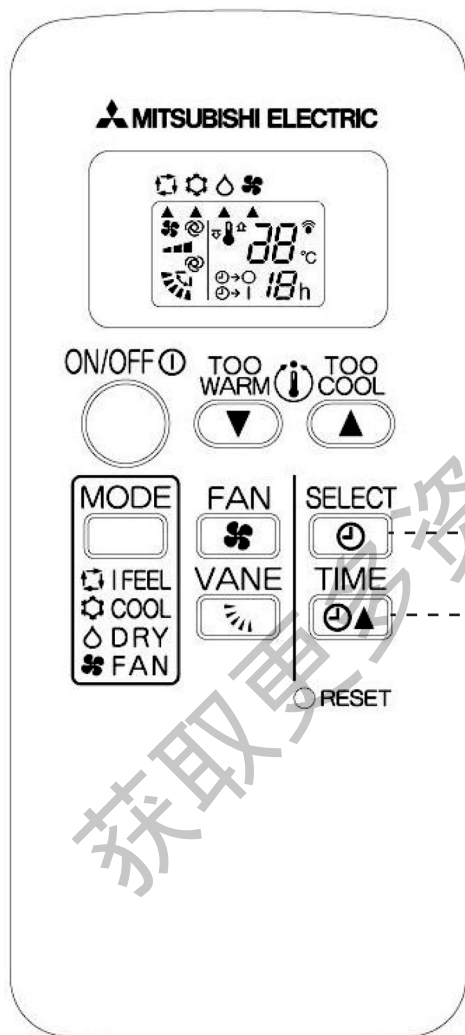
It is convenient to set the timer for the time when you go to bed, when you get home, when you get up, etc.





HOW TO SET THE ON TIMER

- 1** Press the  button during operation. Each time this button is pressed, "⊙·|" display.
- 2** Use  button set the time of timer. Once press  button, the time will increase 1 hour.

How to release the timer.

-  Press the  button.

HOW TO SET THE OFF TIMER

- 1** Press the  button during operation. Each time this button is pressed, "⊙·O" display.
- 2** Use  button set the time of timer. Once press  button, the time will increase 1 hour.

How to release the timer.

-  Press the  button.

NOTE

- ON timer and OFF timer can be set simultaneously.
- Hour set are both available.
- During or after setting the timer, if the  button is pressed, the timer will be released, and the air conditioner will be stopped.
- The maximal time which is set is 12 hours.
- After setting the timer, operation indicator lamp lighted.

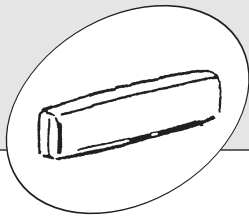

WHEN THE AIR CONDITIONER IS NOT GOING TO BE USED FOR A LONG TIME

When it is not going to be used for a long time:

1 Perform FAN operation for 3 or 4 hours to dry the inside of the air conditioner.

- Before perform fan operation, please set the unit work under the cool mode, and select the highest temperature.

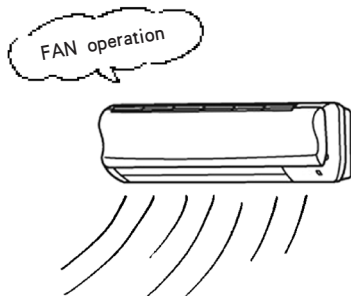

2 Turn off the breaker, then disconnect the power plug.

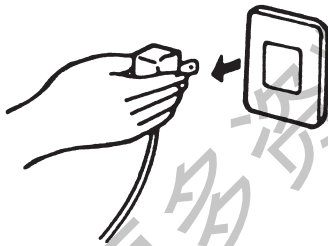

⚠ WARNING

Disconnect the power plug or turn off the breaker when the air conditioner is not going to be used for a long time. Dirt may collect and may cause a fire.

3 Remove the batteries from the remote controller.

When the air conditioner is to be used again:

1 Clean the air filter and install it in the indoor unit. (Refer to page 41 for cleaning it.)

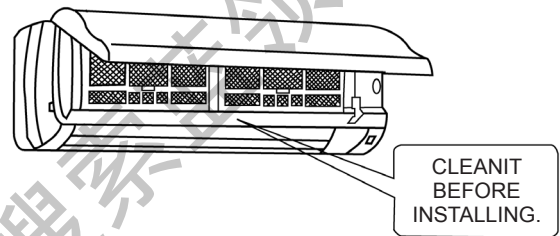

2 Check that the air inlet and outlet of the indoor/outdoor unit are not blocked.

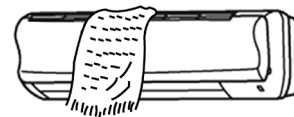

3 Check that the ground wire is connected correctly.

⚠ WARNING

Apply grounding.

- Do not connect a grounding wire to a gas pipe, water pipe, lightning rod or grounding wire of a telephone.
- If a grounding is absent or incorrect, it may cause an electric shock.



MAINTENANCE

Before starting maintenance

Turn off the breaker, then disconnect the power plug.

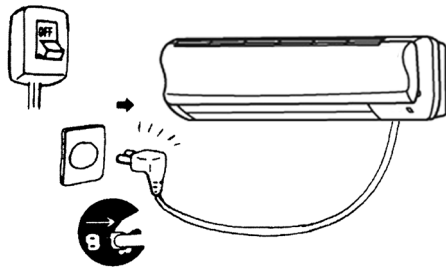

⚠ WARNING

When the unit is to be cleaned, switch off and disconnect the power plug or turn off the breaker. Since the fan rotates at high speed during operation, it may cause an injury.

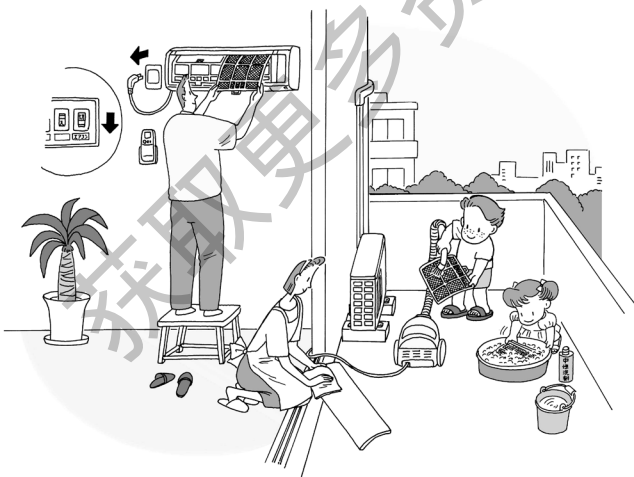

Cleaning the plug

Sweeping dust on the plug.

Cleaning the indoor unit/remote controller

Do not use gasoline, benzene, dilution, polishing powder, detergent, and insecticide. The unit may be damaged.

Detaching and cleaning the front panel

1 Wiping or cleaning by water with soft cloth. After cleaning by water, please wipe the water away, and dry in shade.

2 The water remained at the display section should be extracted from the rear.

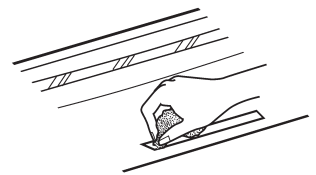

3 Other dirt can use neutral cleanser and soft cloth to clean.

4 Do not use gasoline, benzene, dilution, polish powder, detergent and insecticide. Do not use brush or any other hard tools.

5 Do not put in hot water for long time (2hr above), do not put in the sun directly, and do not put in the valid range of the heater, otherwise, the front panel would be distortion and deformation.

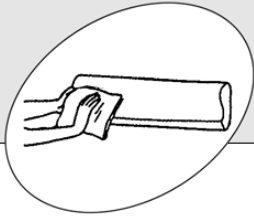

METHOD OF DISASSEMBLY AND INSTALLATION OF THE FRONT PANEL

Disassembly the front panel

- 1 Hold the front panel in both hand,and rise to plane,then pull out.

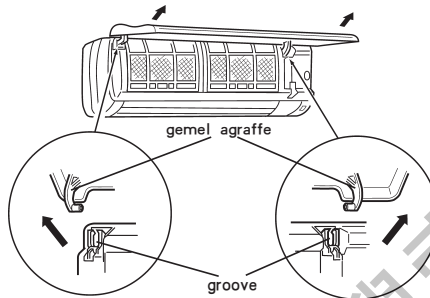

- 2 Do not pull the front panel out by force,and do not drop down,otherwise,the front panel would be damaged.
- 3 Do not step onto an unstable bench when attaching/detaching the front panel.It may cause an injury by falling down.

Installation the front panel

- 1 Hold the front panel in both hand and rise to plane,then insert the gamel on the front panel into the groove on the top of the indoor unit.(Lock until it clicks)

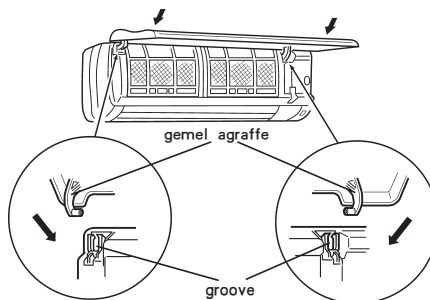

- 2 Hold the front panel in both hand and close the front panel,then press the three place which denote by arrows in the following figure,thus,the installation is done.





CLEANING THE CATECHIN FILTER

When the front panel is to be opened, do not open it up to the level position. If you do, the front panel may come off.

Cleaning the catechin filter.
(about once every 2 weeks)

1 Remove the catechin filter.

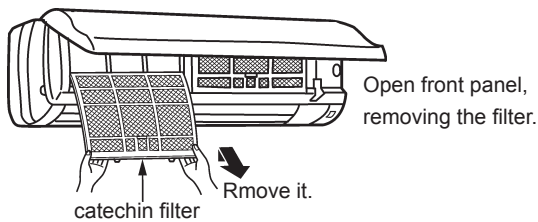

CAUTION

When the catechin filter is to be removed, do not touch the metal parts of the indoor unit. It may cause an injury.

2 Clean dirt from the catechin filter using a vacuum cleaner or by washing with water.

- If dirt is conspicuous, wash with a solution of detergent in lukewarm water.
- If hot water (50°C or more) is used, it may be deformed.

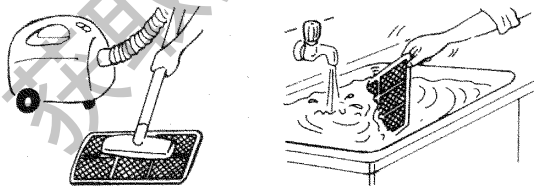

3 After washing with water, dry well in the shade.

- Do not expose the catechin filter to direct sunlight or heat from a fire when drying it.

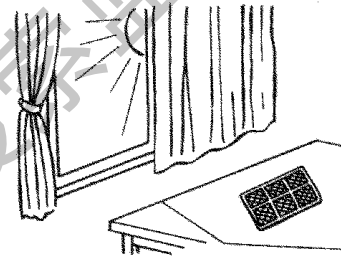

4 Install the catechin filter.

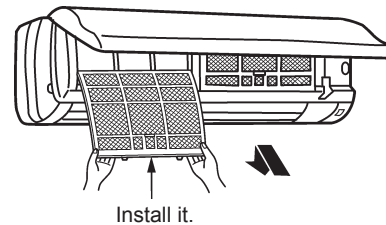

Function of the CATECHIN filter: Along with the resolution of the CATECHIN (composition of green tea), the odour of cigarette and sweat is eliminated, furthermore the germ is restrained to develop, grow up, and breed. (test method: Fiber product's quantitative germproof test method of Japanese textile inspection association.)

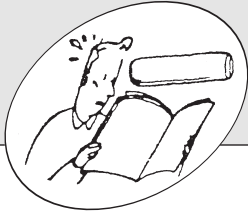

BEFORE CONTACTING THE SERVICEMAN, CHECK THE FOLLOWING AGAIN

The air conditioner cannot be operated.

↓
Check the following.

- 1 The breaker is turned on and fuse is not blown.

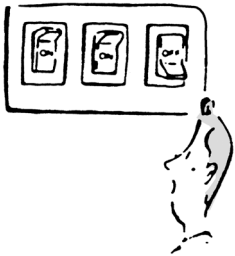

- 2 The ON-timer is not set.



Cannot be cooled sufficiently.

↓
Check the following.

- 1 The temperature setting is correct.



- 2 Air filter is not dirty.



- 3 Outlet of the outdoor unit are not blocked.

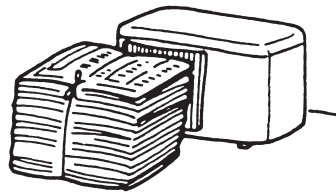

Display of the remote controller does not appear. The remote control signal cannot be received if it is not near the air conditioner.

- 1 The batteries are exhausted.

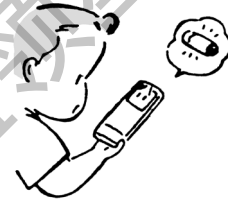

- 2 The polarity(+,-)of the batteries is confused.



When a power failure occurs. → Check the following.

The air conditioner is kept stopping. After the power is restored, pressing the ON/OFF button again.

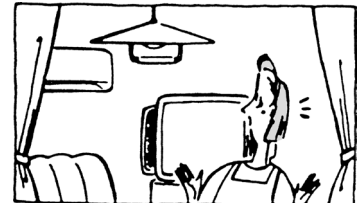

Even if the above items are checked, when the air conditioner does not recover from the trouble, stop using the air conditioner and consult your dealer or service center.

Note the following cases:

- The remote control signal may not be received in a room with an electronic ON/OFF type fluorescent lamp (inverter type fluorescent lamp, etc.) is used.
- In a weak radio wave area, when the air conditioner is operated, noise may be generated in SW radio reception.
- When thunder is heard, stop operation and pull out the power plug or turn off the breaker. Otherwise, the electrical parts may be damaged.



WHEN YOU THINK THAT TROUBLE HAS OCCURED

QUESTION

ANSWER (not a malfunction)

The air conditioner cannot be operated about for 3 minutes when re-started.

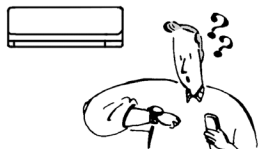

- This protects the air conditioner by instructions from the microprocessor.Wait.

Crack sound is heard.

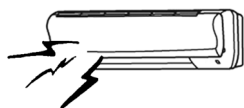

- This sound is generated by the expansion/constriction of the fron panel,etc.due to changes of temperature.

Room smells funny.

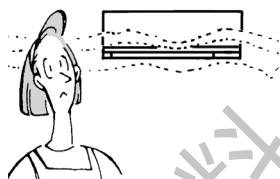

- The air conditioner sucks an odor adhering a wall,carpet,furniture,cloth,etc.and blow it out with air.

Fan stops during the DRY operation.

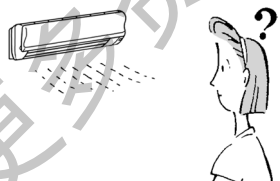

- If water condensing to the heat-exchanger evaporated again,the humidity increase.To prevent this,fan operation of the indoor unit stops when the room temperature has dropped sufficiently.

Water flowing sound is heard.



- This is the sound of refrigerant flowing inside the air conditioner.
- This is the sound of condensed water in the heat-exchanger flowing.

Air flow direction is changed during operation.

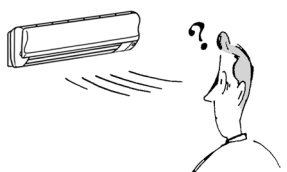

- When the air conditioner is operated in the COOL or DRY mode,if the operation continues with air blowing down for 1 hour,the direction is automatically set to level to prevent condensed water from dropping.



WHEN YOU THINK THAT TROUBLE HAS OCCURED

QUESTION

ANSWER (not a malfunction)

Hissing sound is sometimes heard.



- This is the sound when the flow of refrigerant inside the air conditioner is switched.

Water leaks from the outdoor unit.

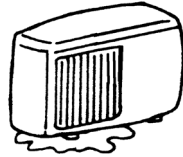

- During cooling operation, pipe or pipe connector section are cool and cause water condensed.

A mechanical sound is heard from the indoor unit.



- This is sound of the switch turning ON/OFF the fan or compressor.

The room is not cooled sufficiently.

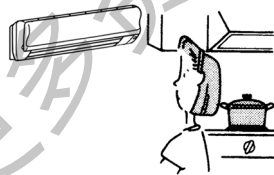

- Because the exhaust fan or stove is in use, the thermal load is high. Thus, the cooling capacity is not enough.
- The cooling capacity is not enough because the outdoor temperature is too high.

During operation, mirage is blown out from the air outlet of the indoor unit.

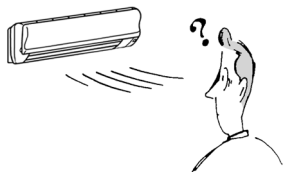

- The moisture in the air meets with the cold air from the air outlet of the indoor unit, and cause the moisture condensed.



INSTALLATION,RELOCATION AND INSPECTION

INSTALLATION PLACE

Avoid installing the air conditioner in the following places.

- Where flammable gas could leak.

⚠ CAUTION

- Do not install the unit where flammable gas could leak. If gas leaks and collects around the unit, it may cause an explosion.
- If the wireless receiver (TV, radio, etc.) has signal disturb where the signal is weak, a signal amplifier is advised to install to improve the receiving quality.

- Where there is much machine oil.
- Salty place such as the seaside.
- Where sulfide gas is generated such as a hot spring.
- Where oil is splashed or is filled with oily smoke.
- Where there is high frequency machine or wireless device (wireless phone or mobile phone).

ELECTRICAL WORK

- Provide an exclusive circuit for power supply of the air conditioner.
- Be sure to observe the breaker capacity.

⚠ WARNING

- The customer should not install this unit. If this is done incorrectly, it may cause a fire, electric shock, injury by dropping of the unit, water leakage, etc.
- Do not connect using branched outlet or an extension cord, and do not attach many loads to one electric outlet. A fire or electric shock may result from poor contact, poor insulation, exceeding the permissible current etc. Consult your dealer or a specialist.

⚠ WARNING

- Air conditioner socket must apply grounding by a special grounding wire. Do not connect a grounding wire to a gas pipe, water pipe, lightning rod or ground wire of a telephone.
- If a grounding is incorrect or absent, it may cause an electric shock.
- Be sure whether there is a grounding wire and whether it is connected correctly.
- Install an earth leakage breaker depending on the place where the air conditioner is to be installed (humid place, etc.). If the earth leakage breaker is not installed, it may cause an electric shock.

TV set, radio or other wireless receiver should be 3m or more away from the outdoor unit. However, if there still is signal disturb, the distance should be lengthened.

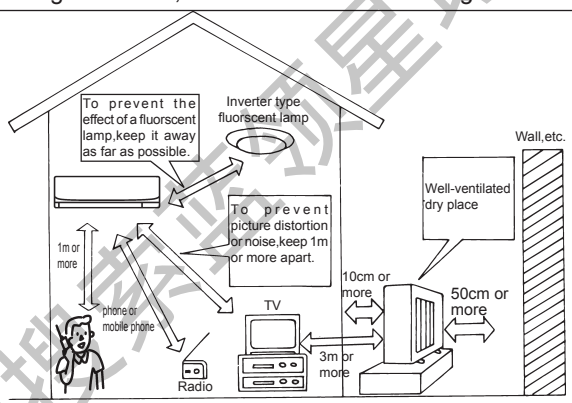

INSPECTION AND MAINTENANCE

- When the air conditioner is used for several seasons, the capacity may be lowered due to dirt inside the unit.
- Depending on the use condition, an odor may be generated or dehumidified water may not drain out smoothly due to dirt, dust, etc.
- It is recommended to apply inspection and maintenance (charged) by a specialist in addition to normal maintenance. Consult your dealer.

ALSO CONSIDER OPERATION SOUND

- Do not put an object around the air outlet of the outdoor unit. It may cause lowering of capacity or increase operation sound.
- If abnormal sound is heard during operation, consult your dealer.

RELOCATION

- When the air conditioner is to be removed or reinstalled because of rebuilding, moving, etc. special techniques and work are required.

⚠ WARNING

Repair or relocation should not be done by the customer. If this is done incorrectly, it may cause a fire, electric shock, injury by dropping of the unit, water leakage, etc. Consult your dealer or service center.

If the power supply cord is damaged, be sure to replace it with the special cord or the special wire assembly bought from the air conditioner factory or the service department.

If you have any questions, consult your dealer.

SPECIFICATIONS

model	MSD-CF09VB-H1	MSD-CF12VB-H1
Electric-shock proof protection	I type	
Power supply	220V ~ 50Hz	
Cooling capacity(W)	2800	3650
Rated power input(W)	890	1160
Rated current(A)	4.2	5.5
Air flow volume(m ³ /h)	553	548
Refrigerant charging(g)	750	1080
Noise (indoor unit(dB(A)))(Hi/Lo)	40/26	40/29
Noise (outdoor unit(dB(A)))	45	46
Net weight (indoor unit)(kg)	10	10
Net weight (outdoor unit)(kg)	27	37
Dimensions H×W×D (indoor unit)(mm)	278×815×238	
Dimensions H×W×D (outdoor unit)(mm)	550×800×285	
Connect pipe length (m)	4	
Highest work pressure of discharge(MPa)	4.15	
Highest work pressure of suction(MPa)	1.64	
Maximum work pressure of heat exchange(MPa)	4.71	
Limit pressure of accumulator(MPa)	1.94	

Note: ❶ Guaranteed operating range:

		Indoor	Outdoor
Cooling	Upper Limit	32°C DB, 23°C DB	43°C DB, -
	lower Limit	21°C DB, 15°C DB	21°C DB, -

❷ The noise value is tested in the condition of laboratory (No background noise).

❸ Test standard: GB/T7725 GB4706 · 32-2004 GB4343 · 1-2003

获取更多资料 微信搜索蓝领星球



MITSUBISHI ELECTRIC CORPORATION

HEAD OFFICE TOKYO BLDG. MARUNOUCHI TOKYO JAPAN 100-8310

WG79A446H01