

HITACHI

Inspire the Next

SPLIT TYPE AIR CONDITIONER

INDOOR UNIT/OUTDOOR UNIT

MODEL

RAS-E10CAK/RAC-E10CAK
RAS-E13CAK/RAC-E13CAK

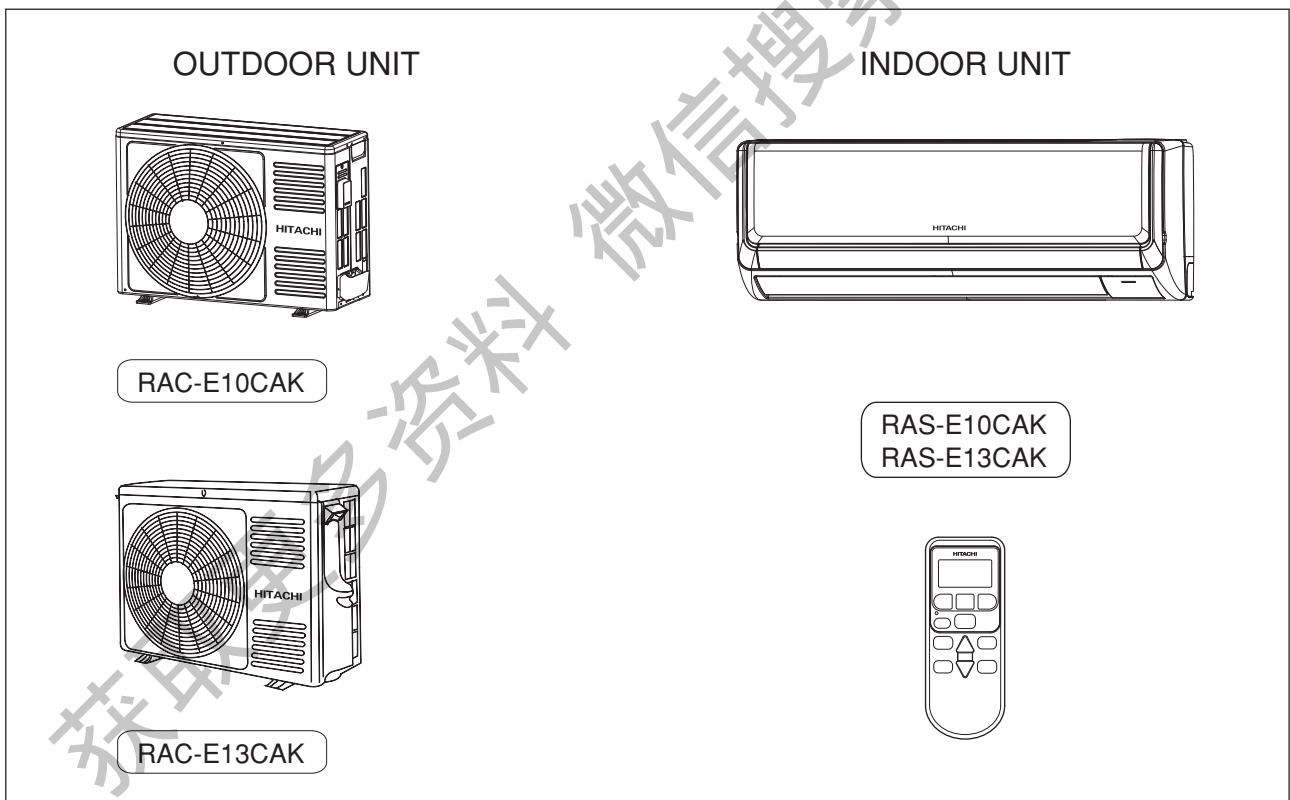

Instruction manual

To obtain the best performance and ensure years of trouble free use, please read this instruction manual completely.

Page 1~20

使用說明書



請詳細閱讀這本使用說明書以了解正確的使用法，使機器長久發揮最高性能。

21~40頁







SAFETY PRECAUTION

- Please read the “Safety Precaution” carefully before operating the unit to ensure correct usage of the unit.
- Pay special attention to signs of “⚠ Warning” and “⚠ Caution”. The “Warning” section contains matters which, if not observed strictly, may cause death or serious injury. The “Caution” section contains matters which may result in serious consequences if not observed properly. Please observe all instructions strictly to ensure safety.
- The signs indicate the following meanings.

 Make sure to connect earth line.	 The sign in the figure indicates prohibition.
 Indicates the instructions that must be followed.	

- Please keep this manual after reading.



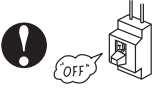

PRECAUTIONS DURING INSTALLATION

 WARNING	<ul style="list-style-type: none"> • Do not reconstruct the unit. Water leakage, fault, short circuit or fire may occur if you reconstruct the unit by yourself. 	
	<ul style="list-style-type: none"> • Please ask your sales agent or qualified technician for the installation of your unit. Water leakage, short circuit or fire may occur if you install the unit by yourself. • Please use earth line. Do not place the earth line near water or gas pipes, lightning-conductor, or the earth line of telephone. Improper installation of earth line may cause electric shock. 	
 CAUTION	<ul style="list-style-type: none"> • A circuit breaker should be installed depending on the mounting site of the unit. Without a circuit breaker, the danger of electric shock exists. 	
	<ul style="list-style-type: none"> • Do not install near location where there is flammable gas. The outdoor unit may catch fire if flammable gas leaks around it. 	
	<ul style="list-style-type: none"> • Please ensure smooth flow of water when installing the drain hose. 	

PRECAUTIONS DURING SHIFTING OR MAINTENANCE

 WARNING	<ul style="list-style-type: none"> • Should abnormal situation arises (like burning smell), please stop operating the unit and turn off the circuit breaker. Contact your agent. Fault, short circuit or fire may occur if you continue to operate the unit under abnormal situation. 	
	<ul style="list-style-type: none"> • Please contact your agent for maintenance. Improper self maintenance may cause electric shock and fire. 	
	<ul style="list-style-type: none"> • Please contact your agent if you need to remove and reinstall the unit. Electric shock or fire may occur if you remove and reinstall the unit yourself improperly. 	
	<ul style="list-style-type: none"> • If the supply cord is damaged, it must be replaced by the special cord obtainable at authorized service/parts centers. 	

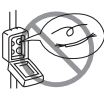
PRECAUTIONS DURING OPERATION

 WARNING	<ul style="list-style-type: none"> • Avoid an extended period of direct air flow for your health. 	
	<ul style="list-style-type: none"> • Do not put objects like thin rods into the panel of blower and suction side because the high-speed fan inside may cause danger. 	
	<ul style="list-style-type: none"> • Do not use any conductor as fuse wire, this could cause fatal accident. 	
	<ul style="list-style-type: none"> • During thunder storm, disconnect and turn off the circuit breaker. 	

PRECAUTIONS DURING OPERATION

- The product shall be operated under the manufacturer specification and not for any other intended use.



- Do not attempt to operate the unit with wet hands, this could cause fatal accident.

- When operating the unit with burning equipments, regularly ventilate the room to avoid oxygen insufficiency.



- Do not direct the cool air coming out from the air-conditioner panel to face household heating apparatus as this may affect the working of apparatus such as the electric kettle, oven etc.

- Please ensure that outdoor mounting frame is always stable, firm and without defect. If not, the outdoor unit may collapse and cause danger.



- Do not splash or direct water to the body of the unit when cleaning it as this may cause short circuit.

- Do not use any aerosol or hair sprays near the indoor unit. This chemical can adhere on heat exchanger fin and blocked the evaporation water flow to drain pan. The water will drop on tangential fan and cause water splashing out from indoor unit.

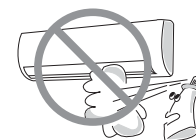

W
A
R
N
I
N
G



- Please switch off the unit and turn off the circuit breaker during cleaning, the high-speed fan inside the unit may cause danger.

- Turn off the circuit breaker if the unit is not to be operated for a long period.



- Do not climb on the outdoor unit or put objects on it.

- Do not put water container (like vase) on the indoor unit to avoid water dripping into the unit. Dripping water will damage the insulator inside the unit and causes short-circuit.



- Do not place plants directly under the air flow as it is bad for the plants.

- When operating the unit with the door and windows opened, (the room humidity is always above 80%) and with the air deflector facing down or moving automatically for a long period of time, water will condense on the air deflector and drips down occasionally. This will wet your furniture. Therefore, do not operate under such condition for a long time.
- If the amount of heat in the room is above the cooling or heating capability of the unit (for example: more people entering the room, using heating equipments and etc.), the preset room temperature cannot be achieved.

- This appliance is not intended for use by young children or infirm persons unless they have been adequately supervised by a responsible person to ensure that they can use this appliance safely.
- Young children should be supervised to ensure that they do not play with the appliance.

PRODUCT PERFORMANCE AND TECHNICAL PARAMETERS

- Fuzzy control
- High performance rotary compressor
- Low noise air intake system
- Temperature sensing automatic dehumidification
- Sleep mode with automatic adjustable temperature controls
- High performance timer
- Remote control swing mode
- Automatic parking air vent grilles
- Automatic fan speed adjustment
- Left right drain hoses
- Automatic functions
- High sensing thermostat
- 3 minute delay circuitry
- 3 fan speed selection
- Flared piping joints
- Instant dehumidifying functions
- High performance cooling functions
- Stainless filter



Fuzzy control

Fuzzy control

The common timer controls will always switch on the air conditioner at a predetermined time that could cause over cooling, however, with this advanced fuzzy control system the air conditioner will be either switched on before preset time or delayed depending on the indoor temperature changes, allowing the room temperature to reach the preset temperature within an optimal time frame, as such it will create an optimal air conditioned environment and will also provide greater savings on electrical energy consumption.



Quiet

Low noise air intake system

This newly modified low noise air intake system allows better and smoother air flows that will provide a quiet and refreshing environment.



Sleep mode with automatic adjustable temperature controls

After adjusting the sleep mode timer before sleep, the temperature will be automatically controlled and adjusted accordingly to the lowering or body temperature during sleep and lower temperature throughout the night, to provide a conducive environment for a good sleep.

An hour after setting the sleep mode timer, the air conditioner will automatically adjust the optimal temperature; during summer it will be adjusted to 2°C higher than the preset room temperature, and the timer can be set at a 1-hour, 2-hour, 3-hour and 7-hour cycle. All can be set by pressing the control buttons that save you the trouble to preset the required operating modes before sleep.



Temperature sensing automatic dehumidification

Hitachi air conditioners are specially equipped with precise and reliable temperature sensing automatic dehumidification function, that automatically operates the dehumidification whenever the room temperature exceeds the preset temperature and it stops whenever the room temperature falls back within the preset temperature as such it stabilizes the temperature and provides a more conducive environment for the user.

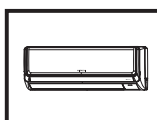

Well designed unit body

The indoor unit incorporates the latest design and has a non-bulky body that measures 221 x 780 x 280mm.

NAMES AND FUNCTIONS OF EACH PART

INDOOR UNIT

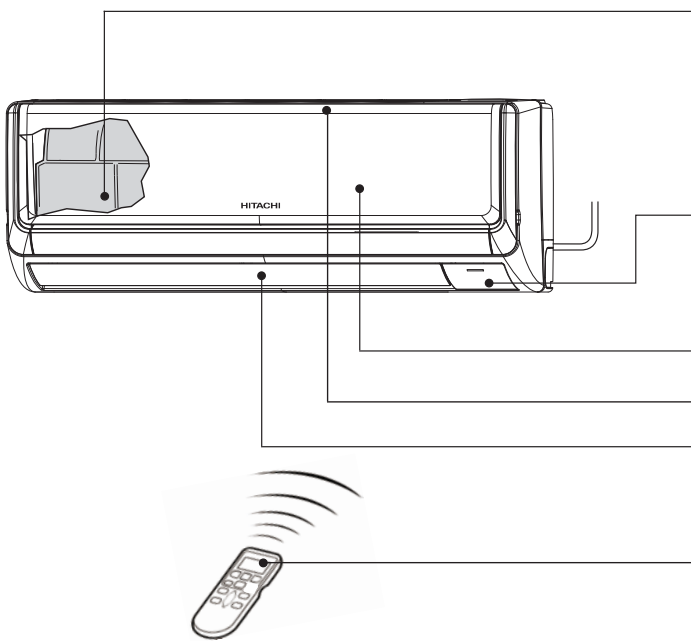

AIR FILTER

To prevent dust from coming into the door unit.
(Refer page 15)

INDOOR UNIT INDICATORS

Light indicator showing the operating condition.
(Refer page 6)

FRONT PANEL

SUPPORT PANEL

HORIZONTAL DEFLECTOR · VERTICAL DEFLECTOR (AIR OUTLET)

(Refer page 13)

REMOTE CONTROL

Send out operation signal to the indoor unit. So as to operate the whole unit.
(Refer page 7)

OUTDOOR UNIT

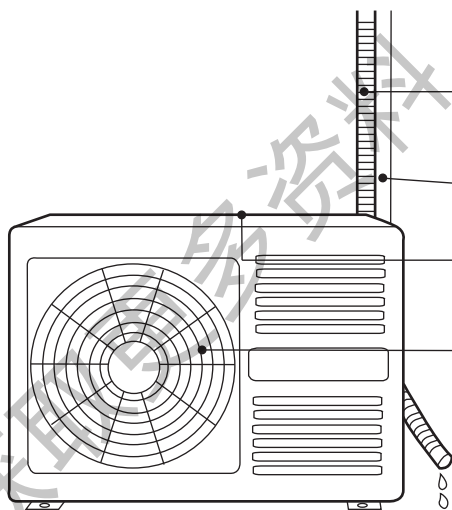

DRAIN PIPE

Condensed water drain to outside.

CONNECTING CORD

AIR INLET (BACK, LEFT SIDE)

AIR OUTLET

MODEL NAME AND DIMENSIONS

MODEL	WIDTH(mm)	HEIGHT(mm)	DEPTH(mm)
RAS-E10CAK, RAS-E13CAK	780	280	221
RAC-E10CAK	700(+59)	505	258(+48)
RAC-E13CAK	750(+91)	548	288(+47)

ATTACHING AND REMOVING FRONT PANEL

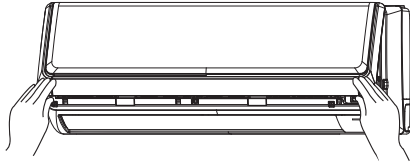

- While gripping both the left and right hand edges [recessed in the front housing] of the front panel, lift up to open the front panel.
- After completion of job, slightly lift up the front panel and pull down to close the front panel. Ensure that the 3 sets of left, centre and right clips are fully secured.

RECEIVABLE INDICATOR FUNCTIONS

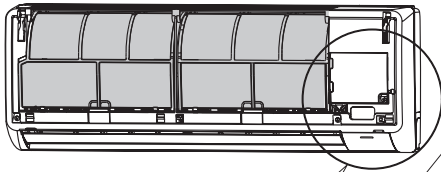

Operation Lamp (YELLOW)

This lamp lights during operation. The lamp flashes when the defrosting is functioning in "heating" mode or at the time the pre-heating is operating in 2 to 3 minutes.

Timer Lamp (ORANGE)

This lamp lights when the timer is working. The lamp flashes periodically when any abnormality occurs in the indoor unit.

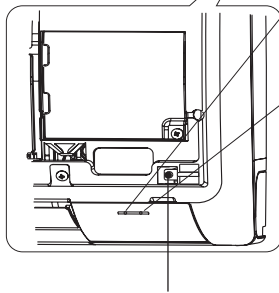

Temporary Switch

OPERATION INDICATOR

TEMPORARY SWITCH

When the remote control device is not functioning, use the Temporary Switch mode

- (1) When the Temporary Switch is pressed, the unit will operate as per the previous setting.
- (2) Press the Temporary Switch a second time will stop the operations of the air conditioner unit.

AUTO RESTART FUNCTION

In the event of power failure, the air conditioner will restart automatically.

In the event of power failure during TIMER operation, the timer will be reset and the unit will begin or stop operating under a new timer setting.

NAMES AND FUNCTIONS OF REMOTE CONTROL UNIT

REMOTE CONTROLLER

This controls the operation of the indoor unit. The range of control is about 7 meters. If indoor lighting is controlled electronically, the range of control may be shorter.

This unit can be fixed on a wall using the fixture provided. Before fixing it, make sure the indoor unit can be controlled from the remote controller.

- **Transmission sign**
The transmission sign blinks when a signal is sent.
- **Display**
This indicates the room temperature selected, current time, timer status, function and intensity of circulation selected.
- **AIR CIRCULATION button**
Use this button to set air circulation in the room or start operation.
- **DEHUMIDIFYING button**
Use this button to reduce water quantity in the room or start operation.
- **COOLING button**
Use this button to set cooling mode in the room or start operation.
- **RESET button**
- **STOP button**
Press this button to stop operation only.
- **SLEEP button**
Use this button to set the sleep timer.
- **FAN SPEED selector**
This determines the fan speed. Every time you press this button, the intensity of circulation will change from Ⓐ (AUTO) to Ⓔ (HI) to Ⓜ (MED) to Ⓛ (LOW) (during the Ⓢ (AIR CIRCULATION) mode, from Ⓔ HI to Ⓜ MED to Ⓛ LOW).
- **AUTO SWING button**
Controls the angle of the horizontal air deflector and to turn off filter lamp.
- **TEMPERATURE button**
Use this button to raise or lower the temperature setting. (Keep pressed, and the value will change more quickly.)
- **OFF-TIMER button** Select the turn OFF time.
- **ON-TIMER button** Select the turn ON time.

	CIRCULATION / START
	DEHUMIDIFY / START
	COOLING / START
	FAN
	FAN SPEED LOW MED HI
	SLEEP TIMER
	STOP
	TIMER SELECTOR ON TIMER OFF TIMER
	AUTO SWING

Precautions for Use



- Do not put the remote controller in the following places.
 - In direct sunlight.
 - In the vicinity of a heater.
- Handle the remote controller carefully. Do not drop it on the floor, and protect it from water.
- Once the outdoor unit stops, it will not restart for about 3 minutes (unless you turn the power switch off and on or unplug the power cord and plug it in again).
This is to protect the device and does not indicate a failure.
- If you press the FUNCTION selector button during operation, the device may stop for about 3 minutes for protection.

COOLING OPERATION

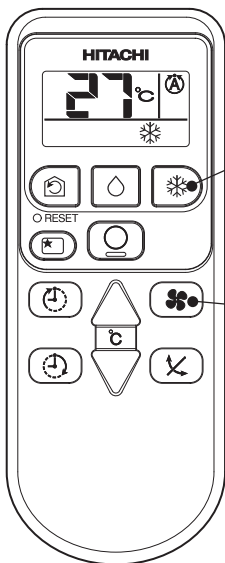
Use the device for cooling when the outdoor temperature is 21-43°C.
If humidity is very high (over 80°C) indoors, some dew may form on the air outlet grille of the indoor unit.



1

Press the  button so that the display indicates  (COOL).

Set the desired FAN SPEED with the  (FAN SPEED) button (the display indicates the setting).

 (AUTO) : The FAN SPEED is HI at first and varies to MED or LOW automatically when the preset temperature has been reached.

 (HI) : Economical as the room will become cool quickly.

 (MED) : Fan speed slow.

 (LOW) : Fan speed slower.

2

Set the desired room temperature with the TEMPERATURE button (the display indicates the setting).

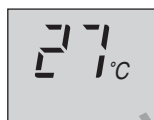



The range of 25-28°C is recommended as the room temperature for cooling.

If the temperature setting is 27°C, the room temperature will be controlled at around 27°C.

The temperature setting and the actual room temperature may vary somewhat depending on conditions.

3

Press the  (COOLING) button. Cooling operation starts with a beep. Press the  (STOP) button to stop operation. The cooling function does not start if the temperature setting is higher than the current room temperature (even though the  (OPERATION) lamp lights). The cooling function will start as soon as you set the temperature below the current room temperature.

STOP

- As the settings are stored in memory in the remote controller, you only have to press the  (COOLING) button next time.

DEHUMIDIFYING OPERATION

Use the device for dehumidifying when the room temperature is over 16°C.
When it is under 15°C, the dehumidifying function will not work.

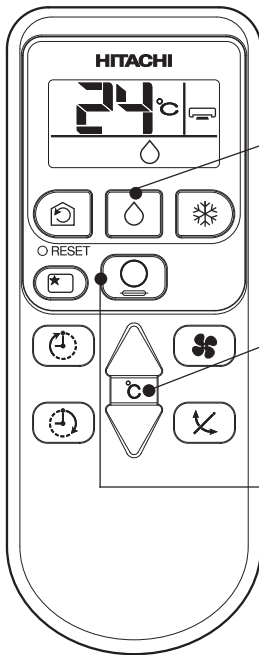

1

Press the  (DEHUMIDIFY) button.
The FAN SPEED is set at LOW automatically.
The FAN SPEED button does not work.



2

Set the desired room temperature with the TEMPERATURE button (the display indicates the setting).



The range of 20-26°C is recommended as the room temperature for dehumidifying.

STOP

Press the  (DEHUMIDIFY). Dehumidifying operation starts with a beep. Press the  (STOP) button to stop operation.

- As the settings are stored in memory in the remote controller, you only have to press the  (DEHUMIDIFY) button next time.

■ Dehumidifying Function

When the room temperature is higher than the temperature setting: The device will dehumidify the room, reducing the room temperature to the preset level.

When the room temperature is lower than the temperature setting: Dehumidifying will be performed at the temperature setting slightly lower than the current room temperature, regardless of the temperature setting. The function will stop (the indoor unit will stop emitting air) as soon as the room temperature becomes lower than the setting temperature.

CIRCULATION OPERATION

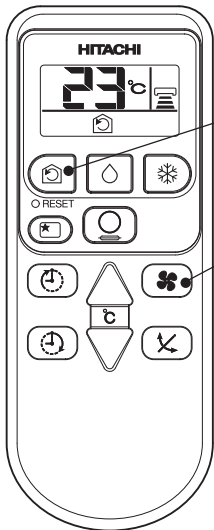

1

Press the  button so that the display indicates (CIRCULATE).



2

Press the FAN SPEED button and select the desired FAN SPEED (the display indicates your choice).

3

Press the temperature control button to set to the desired temperature.

STOP

Press the  (CIRCULATION) button. Circulating operation starts with a beep. Press the  (STOP) button to stop operation.

- As the settings are stored in memory in the remote controller, you only have to press the  (CIRCULATION) button next time.

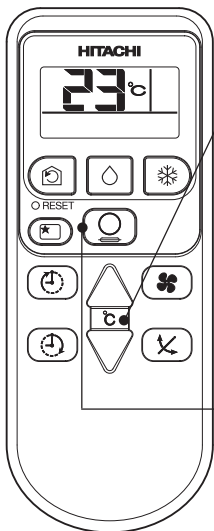

■ Circulation Function

- During circulation operation, compressor will not be running and there is no cooling operation with only indoor fan running.
- When the setting temperature is higher than roomtemperature, indoor fan will stop running.

HOW TO SET THE SLEEP TIMER

Press the  (SLEEP) button, and the display changes as shown below.

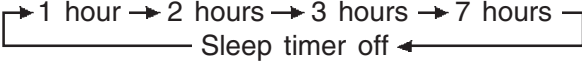
Mode	Indication
Sleep timer	

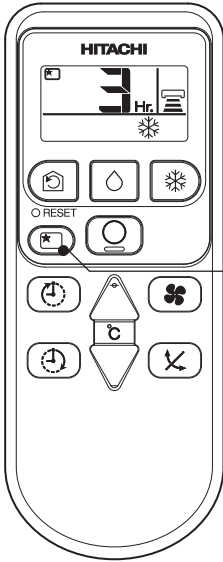

SLEEP

Sleep Timer: The device will continue working for the designated number of hours and then turn off.

Point the signal window of the remote controller toward the indoor unit, and press the SLEEP button.

The timer information will be displayed on the remote controller.

The TIMER lamp lights with a beep from the indoor unit. When the sleep timer has been set, the display indicates the turn-off time.







Explanation of the sleep timer

The device will control the FAN SPEED and room temperature automatically so as to be quiet and good for people's health.

You can set the sleep timer to turn off after 1, 2, 3 or 7 hours. The FAN SPEED and room temperature will be controlled as shown below.

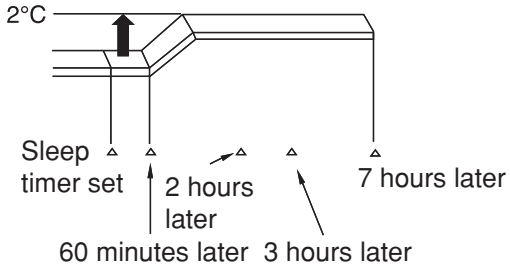
Operation with the sleep timer

Function	Operation
Cooling  and dehumidifying 	The room temperature will be controlled 2°C above the setting temperature and the FAN SPEED will be set to LOW setting 60 minutes after the setting of the sleep timer. 
Fan 	The settings of room temperature and circulation are varied.

HOW TO SET THE TIMER

- ON Timer and OFF Timer are available.

OFF Timer Reservation

OFF TIME setting

- Select the OFF TIME by pressing the  (OFF) Button.
- Setting time will change according to the below sequence when you press the button.

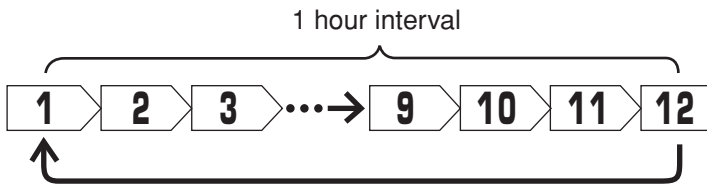

- Operation stop at setting time

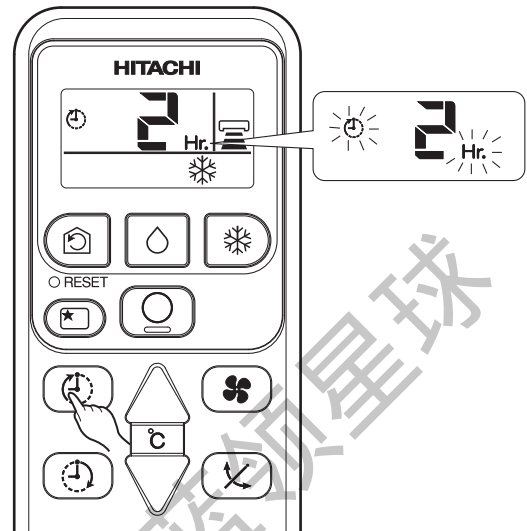

ON Timer Reservation

ON TIME setting

- Select the ON TIMER by pressing the  (ON) Button.
- Setting time will change according to the below sequence.

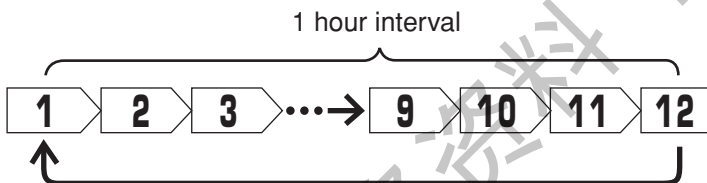

- Operation will start for setting temperature at setting time (The starting time may different depend on the room temperature and set temperature).

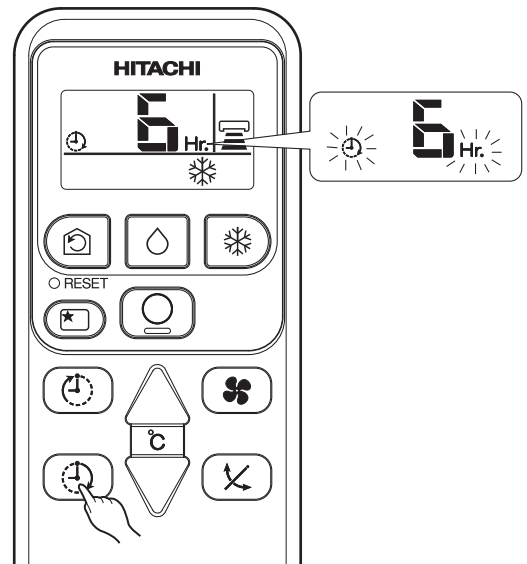

AIR FLOW LOUVERS ADJUSTMENTS

1. Adjusting the left and right air flow directions

Move the vertical air flow louvers as illustrated, to adjust the air flow to flow towards the left or right directions.

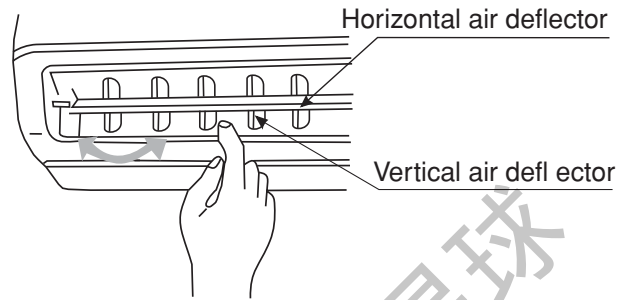

2. Adjusting the downward air flow direction.

During the "Dehumidifying" or "Cooling" operating modes, the horizontal air flow louvers are automatically adjusted to suit the air flow angles of each operating mode. The air flow louvers are designed to direct air flow in upward and downward directions. Pressing the automatic air flow control button, these air flow louvers can also be adjusted to any air flow angle of one's choice.

Press the AUTOMATIC AIR FLOW DIRECTION once will activate the horizontal air flow louvers to direct the air flows upwards and downwards. Press the control button again, the horizontal air flow louvers will stop moving and remain fixed at the position at the point when the control button was pressed.

During the "Dehumidifying" or "Cooling" operating modes, set the horizontal air flow louvers to move within the range as recommended in the illustration.

Adjusting the air flow louvers will direct air flows to assist in reducing the room temperature and to correct any temperature imbalance.

During the "Cooling" operating mode, do not adjust the horizontal air flow louvers to swing outside the range as indicated by arrows in the illustration. Do not operate the horizontal air flow louvers in durations longer than it is necessary. Condensate may form and drip along the horizontal air flow louvers.

After stopping the operations of the unit by pressing  control button, the horizontal air flow louvers will move to park at a position that covers up the air outlet vent.

While the automatic air flow direction mode is in operation, any physical adjustment to the horizontal air flow louvers will shift the swing range. However, with no further physical adjustments, the air flow louvers will readjust automatically to the original swing range setting. (Should the louvers could not return to the original swing range setting, stop the operation of the air conditioner unit, remove the power supply plug and re-plug it into the power mains socket and restart the air conditioner unit. This will return the swing range to its original setting.)

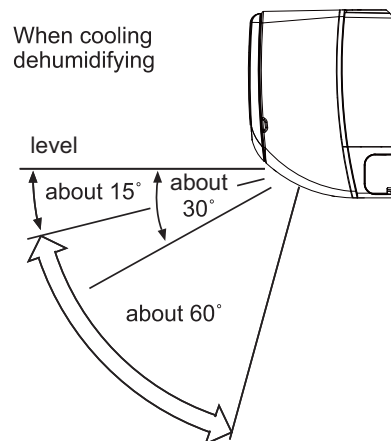
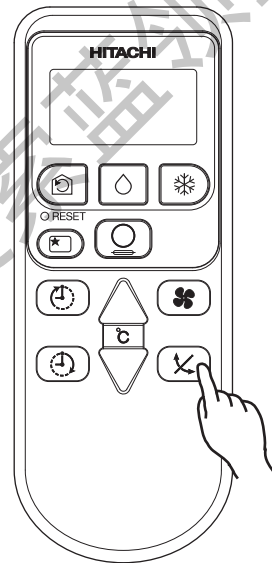

HOW TO EXCHANGE THE BATTERIES IN THE REMOTE CONTROLLER

When using the remote control, there is no response from the air conditioner unit and or the remote control has fading and dim displays, the batteries in the remote control device need to be removed and replaced with new ones

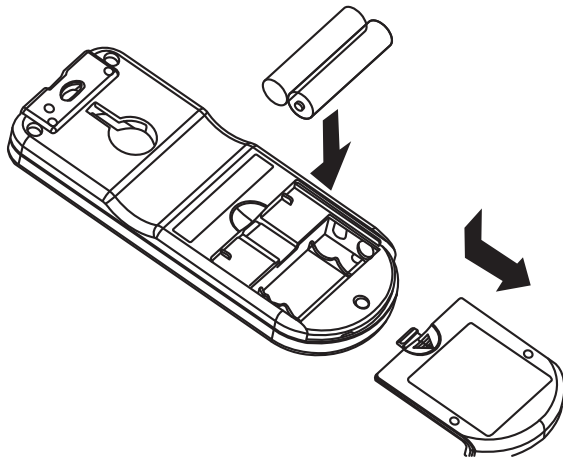

1 Remove the cover as shown in the figure and take out the old batteries.

2 Install the new batteries. The direction of the batteries should match the marks in the case.

CAUTION

1. Do not use new and old batteries, or different kinds of batteries together.
2. Take out the batteries when you do not use the remote controller for 2 or 3 months.
3. Use high quality and high performance AAA batteries to avoid short operating life and electrolyte leakages.

NOTE

1. Remove the air cleansing filters (2) from the front cover, gently press both sides of the air cleansing frame to park it securely at the hooks (six places) and reattach the filters with frame to the front cover
2. The cooling capacity is slightly weakened when the air cleansing frames are used.
3. Air cleansing frames can be used for 20 times. Vacuum cleaner and clean water can be used when cleaning the filters. Please contact the sales agent when you want to renew it.

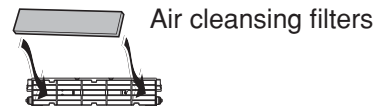
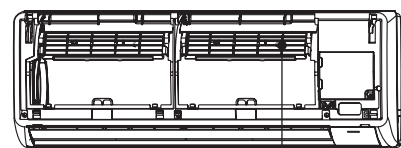



THE IDEAL WAYS OF OPERATION

Suitable Room Temperature



Warning
Freezing temperature is bad for health and a waste of electric power.

Install curtain or blinds



It is possible to reduce heat entering the room through windows.

Ventilation

Caution
Do not close the room for a long period of time. Occasionally open the door and windows to allow the entrance of fresh air.



Effective Usage Of Timer

At night, please use the "sleep timer operation mode", together with your wake up time in the morning. This will enable you to enjoy a comfortable room temperature. Please use the timer effectively.

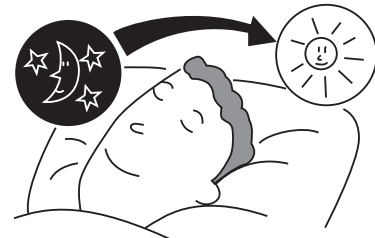

Do Not Forget To Clean The Air Filter

Dusty air filter will reduce the air volume and the cooling efficiency. To prevent from wasting electric energy, please clean the filter every 2 weeks.

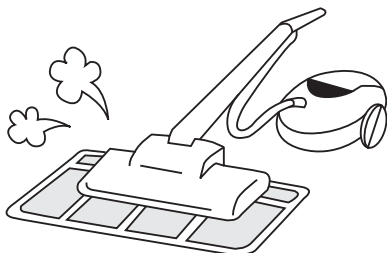

Please Adjust Suitable Temperature For Baby And Children

Please pay attention to the room temperature and air flow direction when operating the unit for baby, children and old folks who have difficulty in movement. (The ideal temperature difference between outdoor and indoor is about $\pm 5^{\circ}\text{C}$).

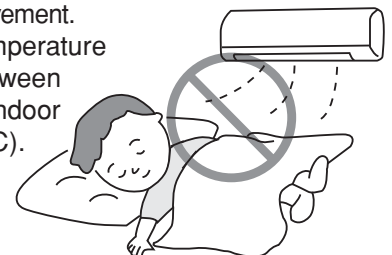



FOR USER'S INFORMATION

The Air Conditioner And The Heat Source In The Room

Caution

If the amount of heat in the room is above the cooling capability of the air conditioner (for example: more people entering the room, using heating equipments and etc.), the preset room temperature cannot be achieved.

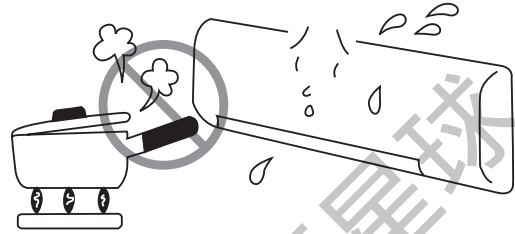

Not Operating For A Long Time

When the indoor unit is not to be used for a long period of time, please pull out the power plug. Or the indoor unit still consumes about 3W in the operation control circuit even if it is in "OFF" mode.

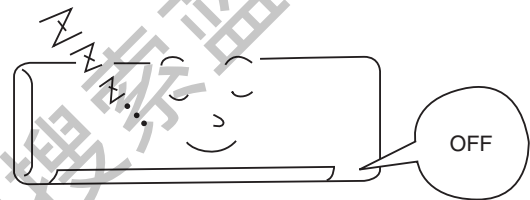

When Lightning Occurs

Warning

To protect the whole unit during lightning, please stop operating the unit and remove the plug from the socket.

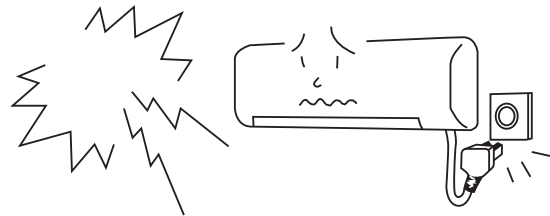

Interference From Electrical Products

Caution

To avoid noise interference, please place the indoor unit and its remote controller at least 1m away from electrical products.

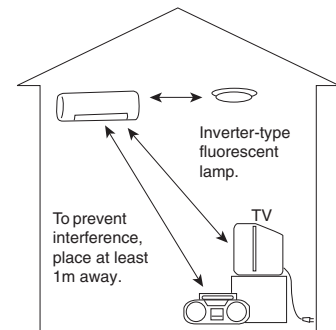

MAINTENANCE OF THE UNITS



CAUTION

Ensure that the unit is not in operation and all power supply has been disconnected before cleaning the units.

Dust Filter Screen

Dust filter screens are installed to remove the indoor dust particles hence they should be kept clean at all times. They should be cleaned at each machine operation cycle of approximately 100 hours. Excessive dust collected at the dust filter screen will block the air flow, reduce the cooling capability and could produce noise. Therefore the dust filter screen should be cleaned as per instructions given below:

Cleaning Instructions

(1) Removing the dust filter screen

- While holding both edges of the front panel, open up and lift the front panel and push in to park at the secured position

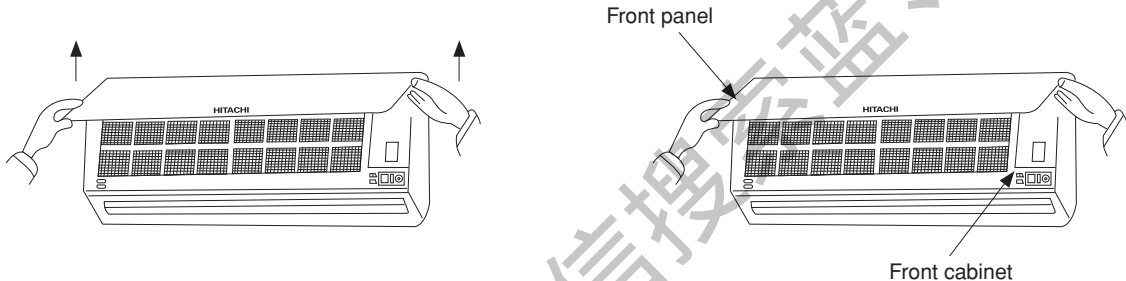

- Slightly lift up the dust filter screen, release the latch clips [2 places] located at the bottom of the front cabinet and move the dust filter screen downwards to remove it from the unit

(2) Use a vacuum cleaner to vacuum clean the dust accumulated at the dust filter screen. If the accumulated dust is too much to be removed by vacuum cleaning, apply mild detergent and flush the dust from the dust filter screen with water. After thorough rinsing, leave the dust filter screen at a cool shaded place to dry.

(3) Re-install the dust filter screen to its original position (With "FRONT" marker facing front). Slightly lift up the opened front panel and close it by returning it to its original position

(4) Each year before using the air conditioner unit, clean the heat exchanger (evaporator) with a fine soft brush or a vacuum cleaner and take care to avoid damaging the evaporator fins

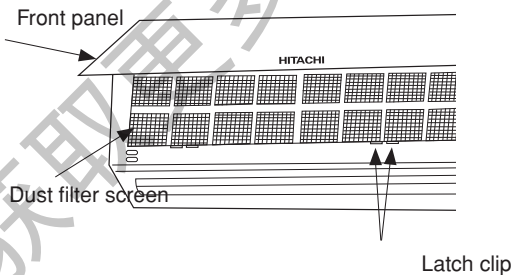

CAUTION

- Do not use hot water (40° C and above) to rinse the dust filter screen, otherwise the screen will warp and get distorted. After rinsing, shake the dust filter screen to rid off all remaining water droplets and place it at a cool shaded place to dry. Avoid placing the dust filter screen under direct sunlight, otherwise the screen will warp and get distorted.

Do not operate the air conditioner unit without the dust filter screen installed, otherwise the ingress of dust into the air conditioner unit will cause breakdowns.

CLEANING THE FRONT PANEL

1. Front panel can easily get dirty. Use a soft cloth to wipe it.
2. If the front panel is excessively dirty, wipe the front panel with a soft cloth either wet with warm water or containing a mild detergent after which, wipe dry the front panel with a soft dry cloth.
3. Do not use hot water (50°C and above), volatile liquid, gasoline, acid, diluting agents or brushes to clean the front panel as they could damage the plastic finishing and paintwork of the front panel.

CAUTION

Please disconnect the power plug before cleaning the front panel.

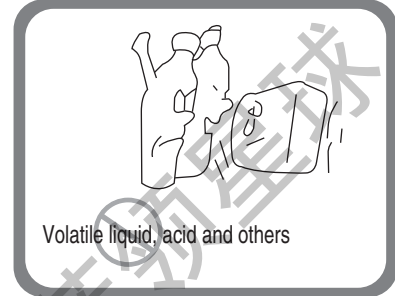
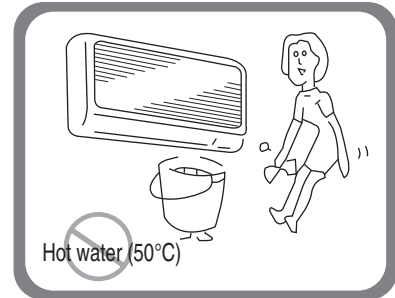

TROUBLE SHOOTING THE UNIT BEFORE CONTACTING SERVICE STAFF TO CHECK AND RECTIFY

The air conditioner unit is not operating.

- Check whether the power supply plug is properly plugged in.

Abnormal air conditioning effects.

1. Is the dust filter screen clogged with dust and dirt?
2. Is the outdoor unit located in direct sunlight?
3. Is there any blockage to the air flow of both the indoor and outdoor units?
4. Are the doors and windows being left opened or is there any heat source inside the room?
5. Is the temperature setting appropriate?

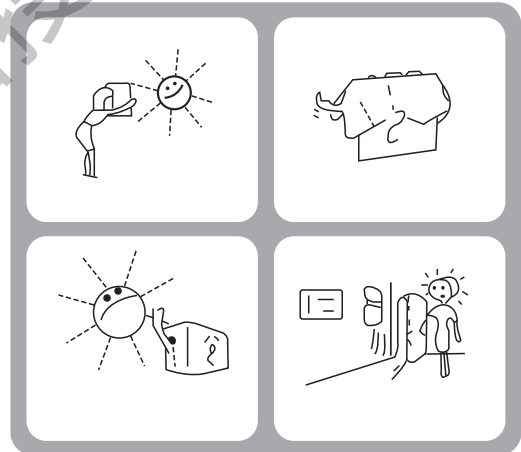



AFTER SALE SERVICE AND WARRANTY

WHEN ASKING FOR SERVICE, CHECK THE FOLLOWING POINTS.

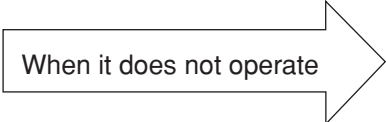
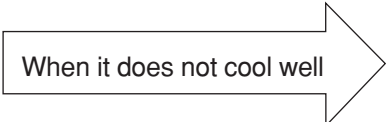
CONDITION	CHECK THE FOLLOWING POINTS
 <p>When it does not operate</p>	<ul style="list-style-type: none"> • Is the fuse all right? • Is the voltage extremely high or low? • Is the circuit breaker "ON"?
 <p>When it does not cool well</p>	<ul style="list-style-type: none"> • Is the air filter blocked with dust? • Does sunlight fall directly on the outdoor unit? • Is the air flow of the outdoor unit obstructed? • Are the doors or windows opened, or is there any source of heat in the room? • Is the set temperature suitable?



Notes

- In quiet or stop operation, the following phenomena may occasionally occur, but they are not abnormal for the operation.
 - (1) Slight flowing noise of refrigerant in the refrigerating cycle.
 - (2) Slight rubbing noise from the fan casing which is cooled and then gradually warmed as operation stops.
- The odor will possibly be emitted from the room air conditioner because the various odor, emitted by smoke, foodstuffs, cosmetics and so on, sticks to it. So please clean the air filter and the evaporator regularly to reduce the odor.

- Please contact your sales agent immediately if the air conditioner still fails to operate normally after the above inspections. Inform your agent of the model of your unit, production number, date of installation. Please also inform him regarding the fault.
- Power supply shall be connected at the rated voltage, otherwise the unit will be broken or could not reach the specified capacity.

This product conforms with the protection requirements of council directives 89/336/EEC relating to electromagnetic compatibility and 73/23/EEC relating to electrical equipment designed for use within certain voltage limits.

Please note:

On switching on the equipment, particularly when the room light is dimmed, a slight brightness fluctuation may occur. This is of no consequence.

The conditions of the local Power Supply Companies are to be observed.

Note

- Avoid to use the room air conditioner for cooling operation when the outside temperature is below 21°C (70°F).

The recommended maximum and minimum operating temperatures of the hot and cold sides should be as below:

		Minimum	Maximum
Indoor	Dry bulb °C	21	32
	Wet bulb °C	15	23
OutdoorD	Dry bulb °C	21	43
	Wet bulb °C	15	26

MEMO

Multiple horizontal dashed lines for taking notes.

HITACHI

Inspire the Next

分離式冷氣機

室內機/室外機

型式

RAS-E10CAK/RAC-E10CAK
RAS-E13CAK/RAC-E13CAK

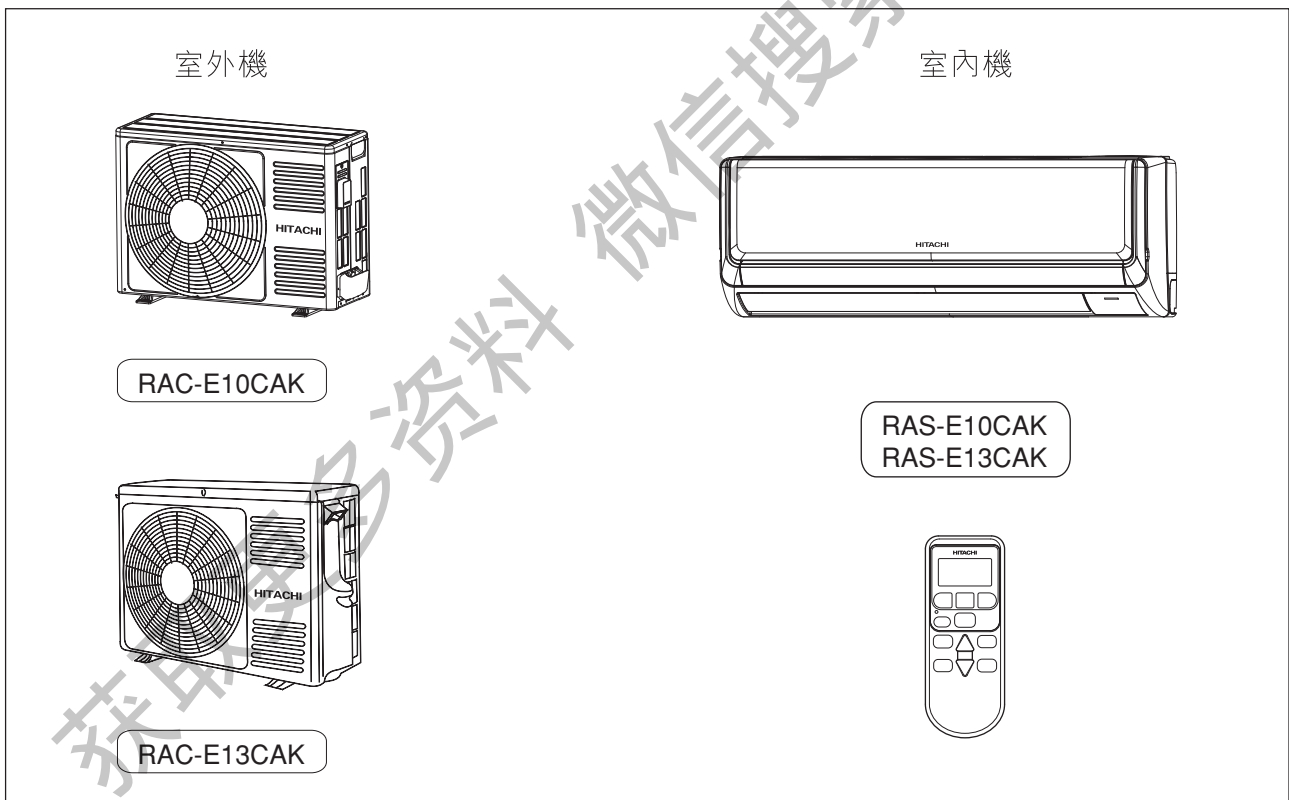

Instruction manual

To obtain the best performance and ensure years of trouble free use, please read this instruction manual completely.

Page 1~20



使用說明書



請詳細閱讀這本使用說明書以了解正確的使用法，使機器長久發揮最高性能。

21~40頁







安全上應特別注意之事項

- 使用前，請詳細閱讀「安全上的注意事項」，以正確的使用機體。
- 在所示注意事項的“ 警告”、“ 注意”需特別加以注意。“警告”欄中記載之事項，表示處理錯誤時，可能會造成死亡或重傷，而“注意”欄中記載之事項，因狀況也可能造成重大之後果，所以請務必遵守，以維護安全。
- 標記事項如下。



 確定地線已連接。	 圖象中的這標記表示禁止事項。
 圖象中的這標記表示必須遵守事項。	

- 閱讀完後，請務必妥善保管。





安裝上的注意事項

 警告	<ul style="list-style-type: none"> ● 請勿重組機件。 自己重組機件可能會造成漏水、故障、觸電及火災。 	
	<ul style="list-style-type: none"> ● 安裝時，請委託經銷商或專門技術人員安裝。 自己安裝可能會造成漏水、觸電及火災。 	
 注意	<ul style="list-style-type: none"> ● 請使用接地線。 地線請勿安裝在瓦斯管、水管、避雷針、電話之地線等場所。 	
	<ul style="list-style-type: none"> ● 依設置場所狀況，有必要安裝漏電斷電器。 如沒有安裝漏電斷電器時，會有觸電的危險。 ● 不可安裝於有可燃氣體的场所，因為萬一氣體泄漏在機體周圍的話，可能會發生火災。 ● 安裝排水管時，請確認水可否順利的流出。 	

搬移或修理時的注意事項

 警告	<ul style="list-style-type: none"> ● 異常時（有焦味等），請停止運轉後把斷電器關閉，並通知經銷服務人員。有異常而照舊連續運轉的話，會造成故障、觸電、火災等。 	
	<ul style="list-style-type: none"> ● 維修時，請直接向經銷服務人員接洽。 自己修理不完全的話，會有觸電、火災的危險。 	
	<ul style="list-style-type: none"> ● 機體要移動重新再設置時，請直接向經銷服務人員接洽。 自己移動機體，重新再設置時，若安裝不安全的話，就會有觸電、火災的危險。 	
	<ul style="list-style-type: none"> ● 如果電線有任何損壞，請從合資格的服務或零件中心購買適用的更換電線。 	

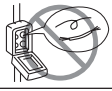
使用上的注意事項

 警告	<ul style="list-style-type: none"> ● 身體請勿長時間直接對著冷氣，以免妨礙健康。 	
	<ul style="list-style-type: none"> ● 請勿將細棒等物品插入吹出口及吸入口，由於風扇在高速運轉，易造成危險。 	
	<ul style="list-style-type: none"> ● 請勿以金屬或銅線當作保險絲，以免發生故障或火災。 	
	<ul style="list-style-type: none"> ● 有打雷之可能時，為了保護機械，請停止運轉，並把斷電器關閉，以避故障發生。 	

使用上的注意事項

- 本機請使用在以一般家庭的人為對象的場所，請勿使用在保存食品、動植物、精密機器、美術品、醫藥品等特殊場所。

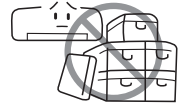

- 請不要用濕手來操作開關，以免觸電。

- 與燃燒器具一起運轉時，請常換氣，否則會有氧氣不足的情形。



- 本機所吹出來的風，請不要直接吹在燃燒器具上，否則，會使燃燒器具燃燒不完全。

- 長期使用的安裝材料請隨時注意其是否穩固，不可有損傷的情形。否則機體可能會落下造成危險。



- 清洗機體時，請絕對避免用水潑機體，因會有漏電的危險。

- 請勿在室內機旁噴酒煙霧或美髮劑。化學物會粘附在散熱片及堵塞蒸發水流向盛水盤。水將會滴在切線形風扇飛濺而出。



警告

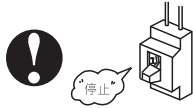

- 清潔機體時，請停止運轉並把斷電器關閉。因為機體內部的風扇正以高速運轉，會造成傷害。

- 長時間不運轉時，為了安全起見，請把斷電器關閉。



- 請勿爬上機體，物品也不要放在機體上面。

- 機體上請不要放有水的容器（如花瓶），以免傾倒流入機體內部，會使機體內部電氣絕緣劣化，產生觸電的危險。

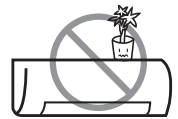

- 動植物請不要放置在風向直接吹到的場所，否則會對動植物有不良的影響。

- 冷氣運轉時，窗和門在開放的狀態下（室內濕度必須在80%以上），風向板向下時，都請不要長時間運轉，否則上下風向板會結露，有時會滴下來，而使傢俱弄濕。

- 房間如果有超過冷氣能力的熱源（如房間有多人進入，使用熱器具等），將無法達到所設定室溫。

- 不要讓小孩單獨操作使用機器。除非在監督責任人的指導下，確保他們能安全正確的使用機器。

- 請確保小孩遠離機體，不要機體玩耍，以免發生危險。

產品功能及技術說明

- 模糊電腦控制
- 高效迴轉式壓縮
- 靜音進氣系統
- 溫度感應自動除濕功能
- 可自動調節溫度的睡眠模式
- 高效定時器
- 遙控運轉模式
- 自動遮蓋出風口
- 自動調整風速
- 左右兩側排水管
- 自動功能
- 高效感應器
- 3分鐘電源緩衝
- 3段風速選擇
- 配管接駁
- 即時除濕功能
- 高效冷卻功能
- 不鏽鋼過濾網



模糊電腦控制

模糊電腦控制

普遍的定時控制器，只會在指定時間開啟冷氣機，導致室溫過低。但由於這項先進的模糊電腦控制，冷氣機會根據室溫的轉變，自動於預設時候之前或之後開啟，讓室溫在最短時間內，達到預設的溫度，以達至最佳的冷氣環境，也可節約用電。

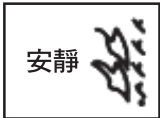

安靜

靜音進氣系統

新改良的靜音進氣系統，讓空氣流通更順暢，提供一個寧靜舒適的環境。



可自動調節溫度的睡眠模式

睡前設定睡眠模式定時器，可根據體溫下降或晚上溫度下降自動控制與調節溫度，提供舒適的睡眠環境。

設定睡眠模式定時器一小時後，冷氣機將自動調節至最合適的溫度，於夏天冷氣溫度將比預設室溫高2°C。定時器可設定為1、2、3 或 7 小時循環。所有功能可利用控制按鈕操作，省卻於睡前預設指定模式的麻煩。



溫度感應自動除濕功能

本機配備準確可靠的溫度感應自動除濕功能，室溫如果高於當時的溫度，冷氣機將自動操作除濕功能，室溫下降至預設溫度時則停止除濕，以穩定溫度及提供舒適的環境。

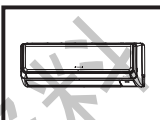

精密設計的機身

室內冷氣機融入最新的設計，輕巧的機身只有221×780×280毫米。

各部的名稱和功能

室內機

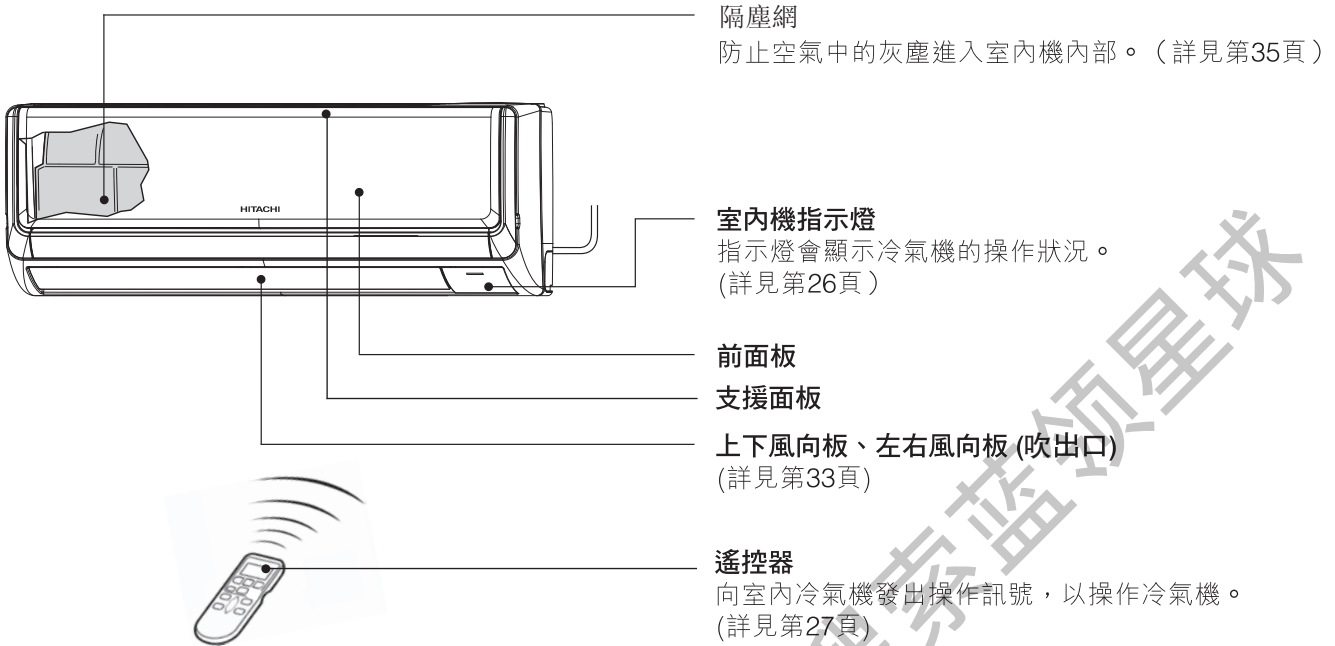

室外機

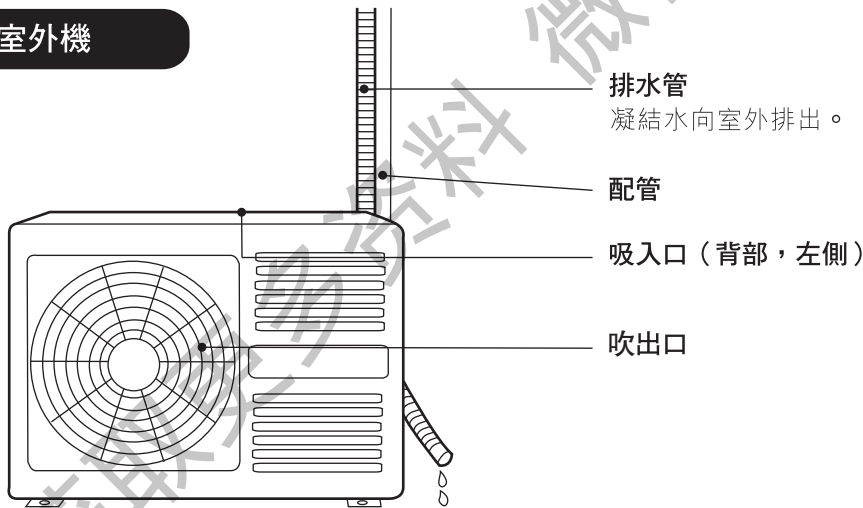

型號及外型尺寸

型號	寬 (mm)	高 (mm)	深 (mm)
RAS-E10CAK, RAS-E13CAK	780	280	221
RAC-E10CAK	700 (+59)	505	258 (+48)
RAC-E13CAK	750 (+91)	548	288 (+47)

裝置及卸下前面板

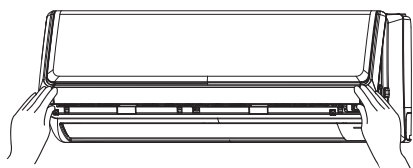

- 雙手握住冷氣機前面板（位於冷氣機的正前方）的兩側，拉起以打開前面板。
- 完成工作後，輕輕拉起面板，然後向下拉合上前面板，檢查左右及中間位置是否已完全合上。

接收指示功能

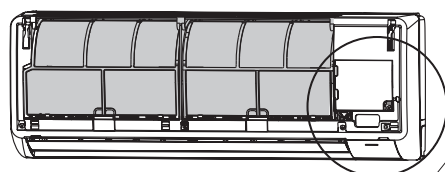

運轉指示燈（黃）

機體保持運轉狀態時，此指示燈會亮。於製熱化霜及預熱冷氣機的 2-3 分鐘，此指示燈會閃動。

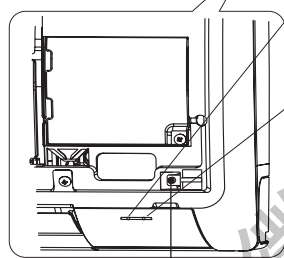

定時指示燈（橙）

機體做預約定時時，此指示燈會亮。冷氣機出現故障時，此指示燈會閃動。

暫時開關

操作指示

暫時開關

無法使用遙控器時，請使用暫時開關模式。

- (1) 按下暫時開關時，機器以前次所設定的模式開動。
- (2) 第二次按暫時開關，以停止冷氣機操作。

自動重開功能

電力故障後，冷氣機將自動重開。

※（電力故障發生時，如遙控器設定為定時器狀態，冷氣機將不會自動重啟。）

遙控器各部名稱和功能

遙控器

這遙控器用以控制室內機的運轉。控制範圍是約7米以上。如要用電子方法控制室內照明的話，控制範圍則可能比較短。

這遙控器可用附屬的配件裝牆壁上。安裝以前請先確認室內機能否由這遙控器來控制。

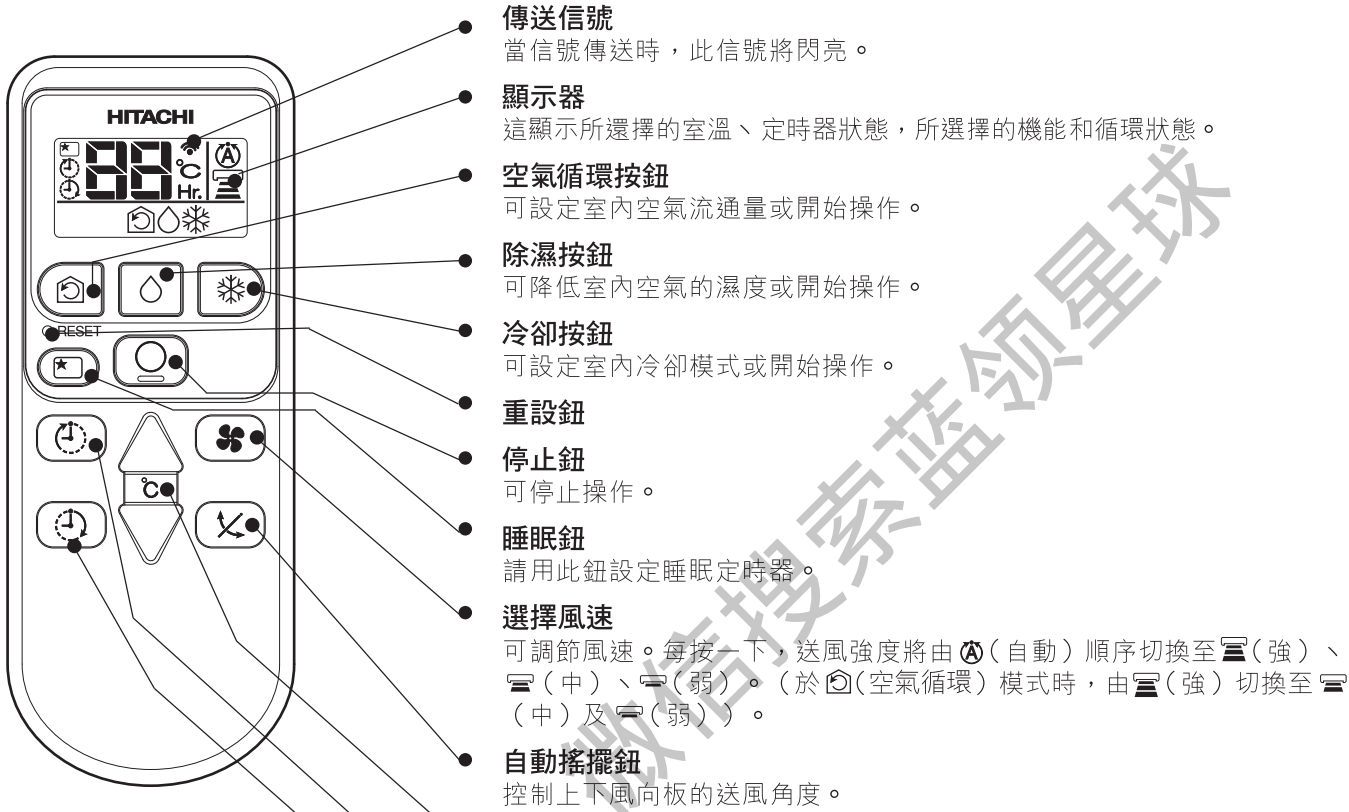

	空氣循環 / 開啟
	除濕 / 開啟
	冷卻 / 開啟
	風扇
	風速 弱 中 強
	睡眠定時器
	停止
	定時器選擇 開 關
	自動搖擺



使用時應注意事項

- 遙控器不可放在下述地方。
 - 直射陽光下
 - 加熱器附近
- 遙控器應小心使用，不可掉落於地板下。請小心避免受濕。
- 室外機一旦停止後約3分鐘不能再開動（除非將電源開關一開一關，或把電源軟線拔掉後再插進去）。
- 在運轉中加按下動作模式選擇鈕的話，機器就會停止3分鐘左右以保安全。

冷卻動作

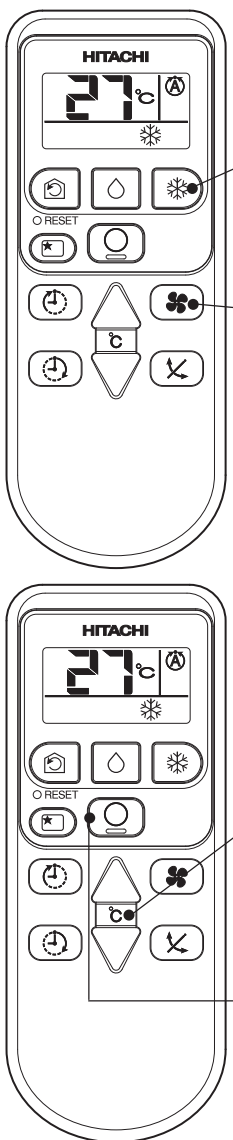
當屋外溫度在攝氏21度至43度的範圍內時可用本機進行冷卻工作。
如室內濕度很高（80%以上）時，室內機放氣口格柵上會結露。





1 按下  鈕，使顯示器指示 （冷卻）。

用 （風扇速度）鈕設定所希望的風扇速度（顯示器指示設定速度）。

（自動）：風扇速度起先是（強），然後達到了預設溫度時自動改變為（中）或（弱）。

（強）：室溫降低較快，省時省能。



（中）：穩靜。

（弱）：更穩靜。

2 用溫度調節鈕設定所希望的室溫（顯示器指示設定溫度）。

 冷卻工作時的室溫範圍最好是攝氏25度至28度。如設定溫度是27度的話，室溫就被控制於攝氏27度左右。

設定溫度和實際的室溫有時可能稍微不同。

3 按下 （冷卻）鈕，機器就發出笛聲而開始冷卻工作。要停止冷卻工作時按 （停止）鈕。如所設定的溫度高於當時的室溫的話冷卻機就不能開動（但 （運轉）指示燈亮）。這時只要將溫度設定於低於當時室溫的水平的話，冷卻機能就立刻開動。

停止

■ 各項設定狀態全被存儲於遙控器的存儲中，所以下次操作機器時只要按下 （冷卻）鈕就好。

除濕動作

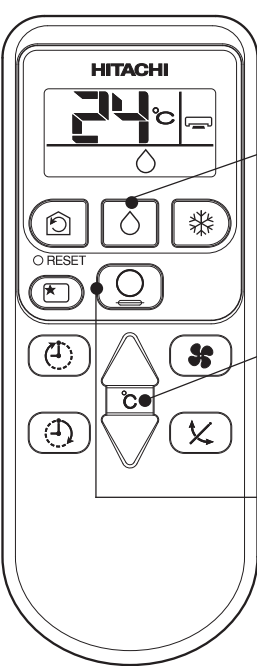

室溫高於攝氏16度時可用本機進行除濕工作。
當室溫低於攝氏15度時除濕功能不能起動。



1 按  (除濕) 鈕。
風扇速度自動設為低。
無法使用風扇速度鈕。

2 請用溫度調節鈕設定所希望的室溫 (顯示器指示設定溫度)。

 除濕工作時的室內溫度範圍最好是攝氏20度~26度。

停止 按下  (除濕) 鈕，機器就發出笛聲而開始除濕工作。要停止除濕工作時按  (停止) 鈕。

■ 各項設定狀態全被存儲於遙控器的存儲中，所以下次操作機器時只要按下  (除濕) 鈕就好。

■ 除濕機能

室溫高於設定溫度時；機器開始去除室內濕氣，使室溫降低到預設水平。
室溫低於設定溫度時；將室溫設定於低於實際的室溫時（無論設定溫度如何），機器就進行除濕工作。當室溫低到設定溫度以下時，除濕工作就立刻停止（室內機停止發出空氣）。

空氣循環動作

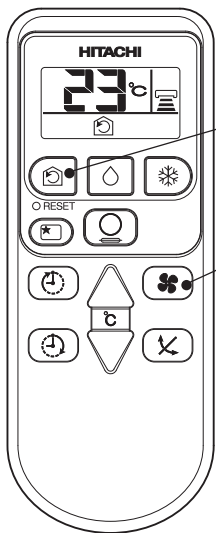

1

按下  (循環) 鈕，使顯示器指示  (循環)。



2

按下風扇速度鈕而選擇所希望的風扇速度 (顯示器指示所選擇的速度)。

3

按下溫度調整鈕以設定所希望的溫度。

停止

按下  (循環) 鈕，機器就發出笛聲而開始循環工作。要停止時按  (停止) 鈕。

- 各項設定狀態全被存儲於遙控器的存儲中，所以下次操作機器時只要按下  (循環) 鈕就好。

■ 循環功能

- 在循環運轉期間，壓縮機不會工作且機器不會冷卻運轉，僅室內風扇運轉。
- 當設定溫度高於室溫時，室內風扇將停止運轉。

睡眠定時器的設定法

按 (睡眠) 鈕，將如下更改顯示。

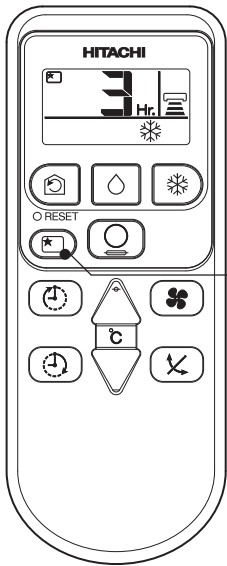

睡眠

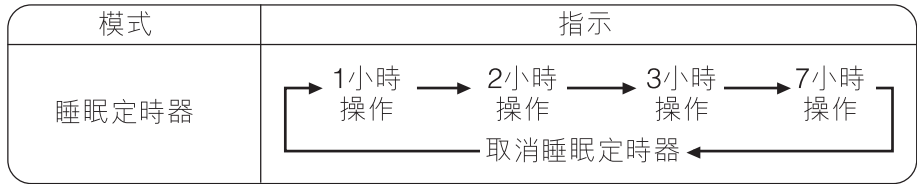

睡眠定時器將繼續於設定定時內操作及關閉。
 將遙控器對準室內機，再按下睡眠鈕。
 定時器資料將顯示於遙控器上。
 定時器指示燈會閃動，同時室內機會發出笛聲。設定睡眠定時器後，將顯示關閉時間。

睡眠定時器說明

此裝置可自動控制風扇速度與室溫，提供寧靜的環境，有助人體健康。可設定定時器於 1、2、3 或 7 小時後關閉，並以下列方法控制風扇速度與室溫。

操作睡眠定時器

功能	操作
製冷 “❄️” 與除濕 “💧”	在睡眠定時器設定時間60分鐘後，室溫將控制在比設定溫度高2°C的水平，風扇速度也會設定為弱。
風扇 “🌀”	室溫與空氣循環有多種設定

定時器的設定法

■ 可開啟及關閉定時器。

預留關閉時間

設定關閉時間

- 按  (開啟) 鈕關閉時間。
- 按照下列程序選按鈕，可更改設定時間。

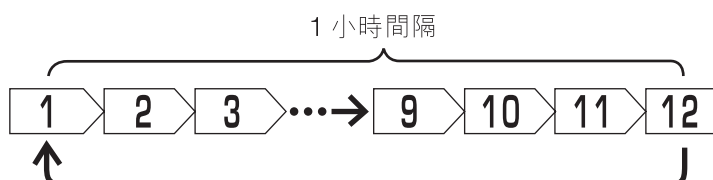

■ 於設定時間停止運作

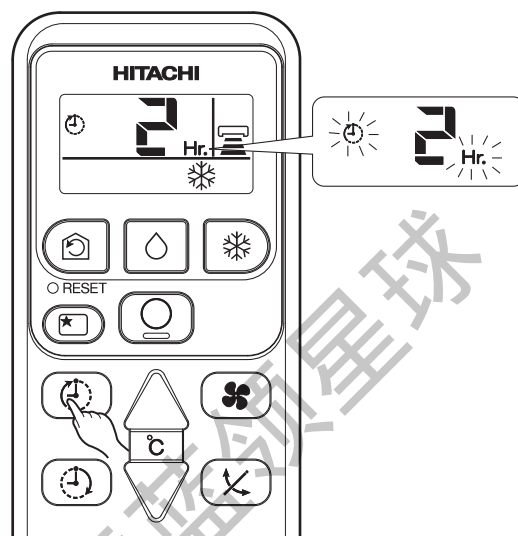

預留開啟時間

設定開啟時間

- 按  (開啟) 鈕開啟時間。
- 按照下列程序選按鈕，可更改設定時間。

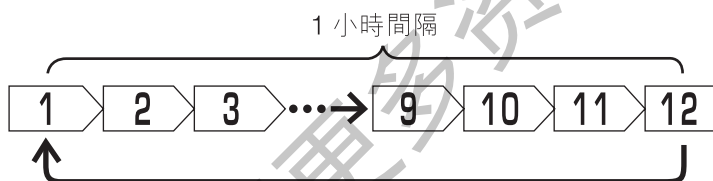

■ 於設定時間，開始運作設定的溫度 (開始時間會因室溫及設定溫度而有所不同)。

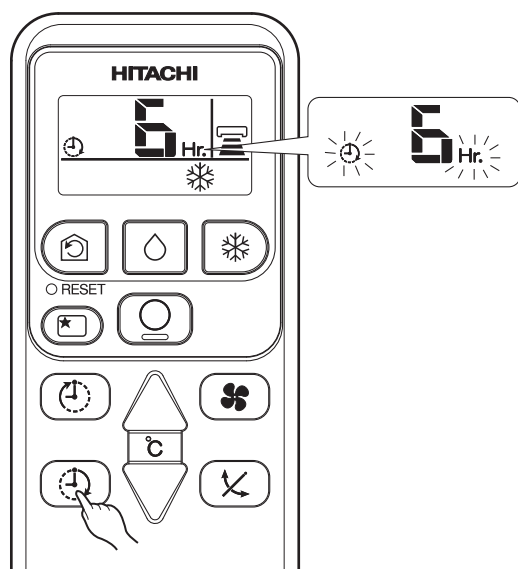

風向板的調節法

1. 向左右調節冷氣方向。

拿住垂直風向板如圖所示而向左右調節冷氣方向。

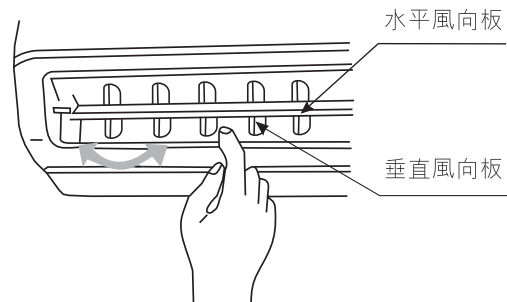

2. 向上下調節冷氣方向。

在“除濕”或“冷卻”動作中，水平風向板自動被設定於適合每一種動作的適當角度。這風向板能上下搖擺，也可用“自動風向”鈕設定於所希望的角度。

按一次自動風向鈕時，水平風向板會上下搖擺。再次按下此鈕時，風向板會在當時的位置上停止。

在“除濕”或“冷卻”動作中，建議調整風向板的送風角度，如圖中所示。

調整風向板的送風角度，有助降低室溫，及修正任何溫度失衡的情況。

在“冷卻”動作中，請勿調整水平風向板，令送風角度大於下圖箭嘴所示之角度。請勿長時間使用水平風向板。水平風向板上會形成及滴下水點。

按  (停止) 鈕停止機器操作後，水平風向板將移回並掩蓋吸出口。

操作自動氣流模式時，手動調整水平風向板，可改變送風角度。但是如果沒有手動調整，風向板將自動重新調整至原來的送風角度。(如果風向板無法調整至原來的送風角度，請停止操作冷氣機，拔掉電源插頭並重新插入主電源插座，然後重新開啟冷氣機。風向板應可調整至原來的送風角度。)

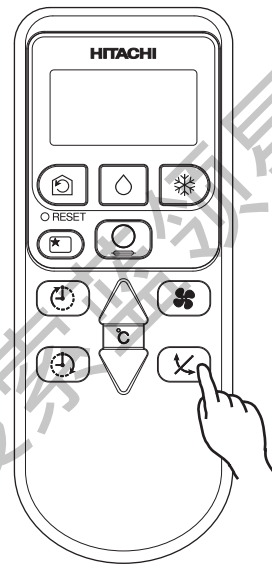

冷卻，除濕時

水平

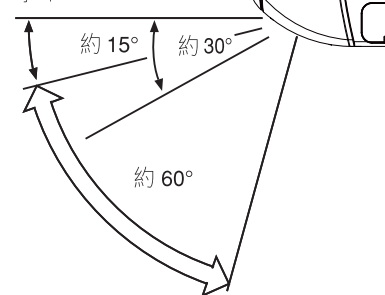

遙控器中電池的更換法

如無法使用遙控器操作冷氣機，或遙控器沒有或暗淡顯示圖示，請更換遙控器內的電池。

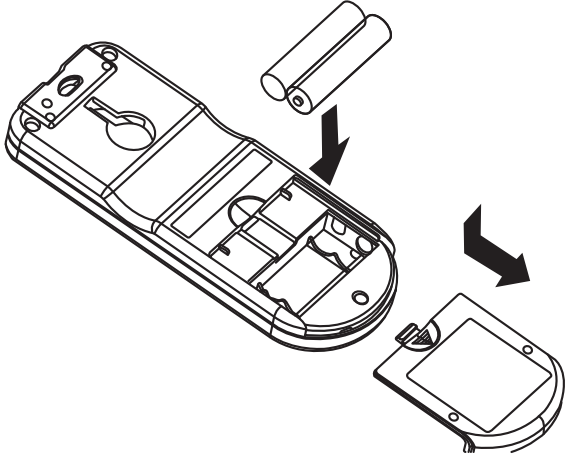

1 取下電池盒蓋如圖所示，然後取出舊電池。



2 將新電池裝進去。
請注意電池極性方向應和盒內所示標記一致。

▲ 注意

1. 新電池和舊電池，或不同種類的電池不可混用。
2. 兩個月或三個月不使用遙控開關時最好把電池取出。
3. 使用高質素及高效能的AAA電池，可延長操作時間，避免電解質外流。

注意事項

- 將兩個空氣濾盒從面框上輕輕取下，輕按空氣清淨濾網兩邊卡住空氣濾盒的位置（共六處），再把裝好空氣清淨濾網的空氣濾盒重新裝入面框。
- 使用空氣清淨濾網後，冷氣機的空調效能會稍微下降。
- 空氣清淨濾網可重複使用 20 次，可用吸塵機清潔或以清水沖洗。如需更新，請聯絡經銷商。

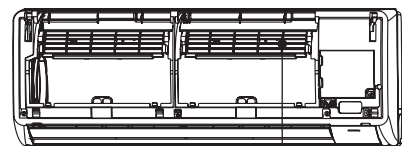

空氣濾盒





最佳的使用方法

室溫設定要適當

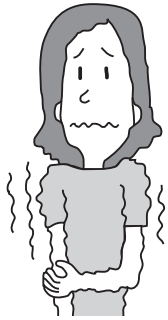

警告

過冷對健康不好且會浪費電力。

裝置窗簾或百葉窗

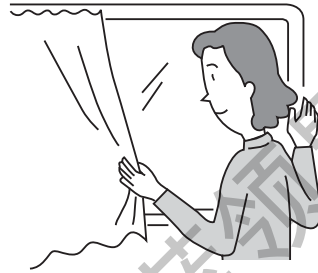

可隔絕從窗戶進來的熱源。

換氣

注意

房間不要關閉太久，請偶爾打開窗戶，換新鮮空氣。



時間預校的有效活用

晚上用“開關時間預校”再配合早上的睡醒時間，可得到舒適的溫度，請有效活用時間預校。

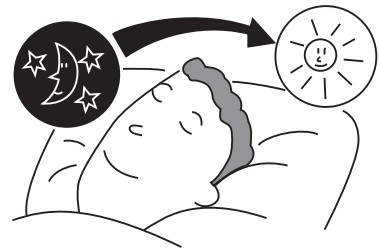

濾網請不要忘記清洗

濾網的網目塞住會影響風量，減弱冷氣效果，為了不浪費電力，請每隔 2 週務必清洗一次。

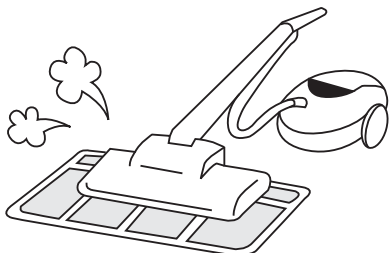

為了嬰兒及小孩，請注意室溫調節

行動不便的嬰兒、小孩、老年人等使用冷氣機時，請注意室內溫度及風向的調節。

(最佳的室內和室外溫差為攝氏±5度。)

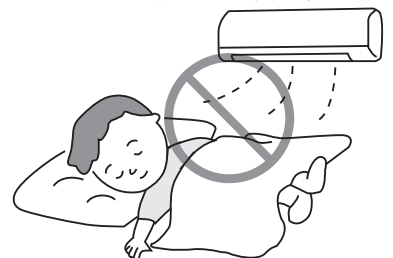



顧客須知

冷氣機和房間的熱源

注意

房間如果有超過冷氣能力的熱源（如房間有多人進入，使用熱器具等），將無法達到所設定的室溫。

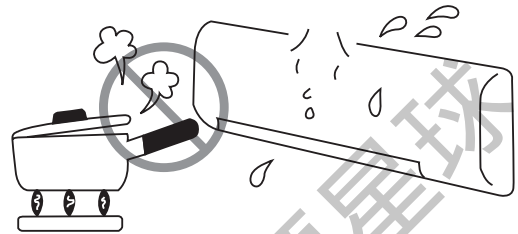

長時間不使用時

機器長時間不使用時，請將電源插頭拔起。否則，雖然不運行，亦會消耗掉使用於控制回路的電力（約3W）。

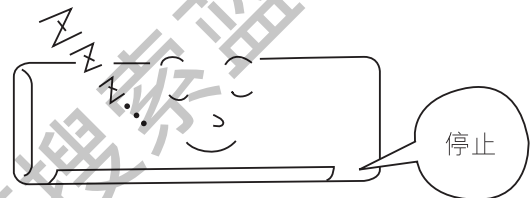

有閃電之虞時

警告

有閃電之虞時，為了保護機械而需停止運轉，請把電源插頭拔起。

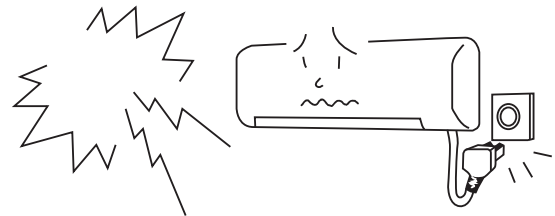

其他電器的干擾

注意

請將室內機及遙控器安裝在距離其他電器至少1米以
避免雜聲的干擾。

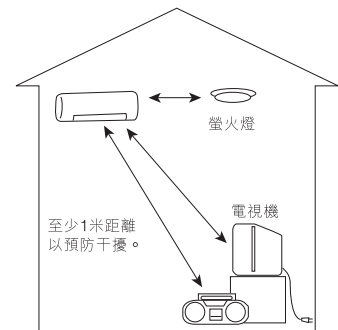

機器的保養

⚠ 注意

清潔冷氣機前，請關閉冷氣機並拔掉電源插頭。

隔塵網

隔塵網可過濾外來的塵埃粒子，所以應時常保持清潔。冷氣機操作約 100 小時後，便應清潔隔塵網。隔塵網上過量的灰塵，將阻礙空氣的流動，減低冷氣效能，冷氣機甚至會發出噪音。因此應清潔隔塵網，清潔說明如下：

清潔說明

(1) 移除隔塵網。

- 雙手握著前面板的兩邊，拉開並揭起前面板，然後推入以固定前面板。

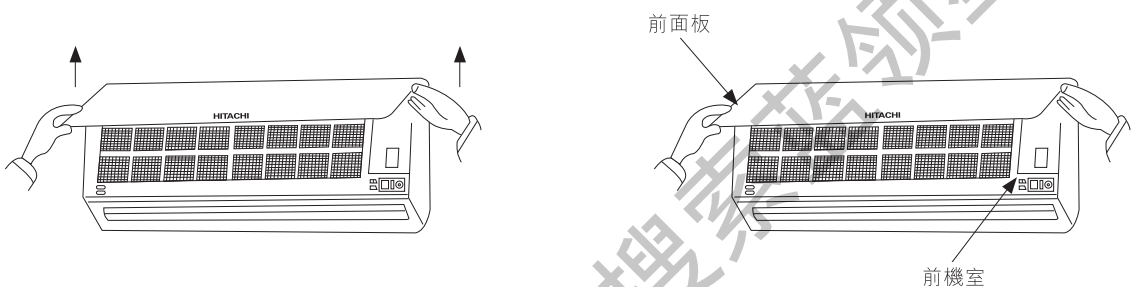

- 輕輕拉起隔塵網，鬆開於前機室下方的兩個門夾，以拉出隔塵網。

- (2) 用吸塵機清潔隔塵網積聚的灰塵。如果無法用吸塵機完全清除積聚的灰塵，可使用中性的清潔劑，並用清水沖洗隔塵網。清洗後，請將隔塵網置於陰涼處風乾。

- (3) 最後，把隔塵網裝回原處（標有“FRONT”的那一面）。輕輕拉開前面板，並於原來位置合上面板。

- (4) 每年也應清潔蒸發器，在使用冷氣機前，可用軟毛刷子或吸塵機清潔蒸發器，但請小心，避免損壞蒸發器。

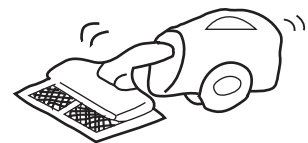
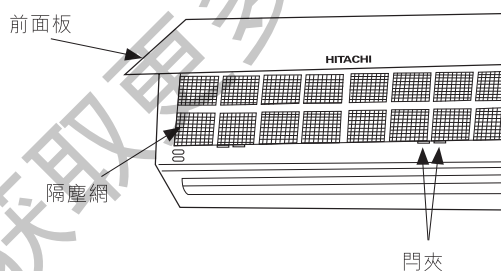

⚠ 注意

- 請勿使用超過 40°C 的熱水沖洗隔塵網，否則隔塵網會彎曲變形。沖洗後，搖動隔塵網，清除多餘的水分，然後將隔塵網置於陰涼處風乾。避免陽光直接照射隔塵網，否則隔塵網會彎曲變形。開啟冷氣機前，請安裝隔塵網，否則吸入的塵埃可能會損壞冷氣機。

清潔前面板

1. 前面板容易積聚污垢，可用軟布清潔。
2. 如果前面板非常骯髒，可用沾有溫水或中性清潔劑的濕布拭抹，然後再用乾布抹乾前面板。
3. 請勿使用超過 50°C 的熱水、揮發性液體、汽油、酸性液體、稀釋液或刷子清潔前面板，否則會損壞前面板的塑膠光油與漆面。

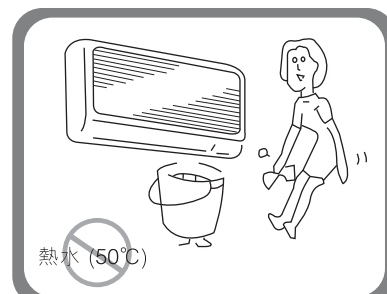

⚠ 注意

清潔前面板前，請拔掉電源插頭。

聯絡服務人員前請檢查下列各項目

冷氣機不能操作。

- 檢查電源插頭是否已正確插好。

冷氣機出現不正常反應。

1. 隔塵網是否積滿灰塵及污垢？
2. 陽光是否直射在室外機上？
3. 室內或室外機的空氣流動是否受阻？
4. 房門或窗口是否開著或是否室內有其他熱源？
5. 設定溫度是否適當？

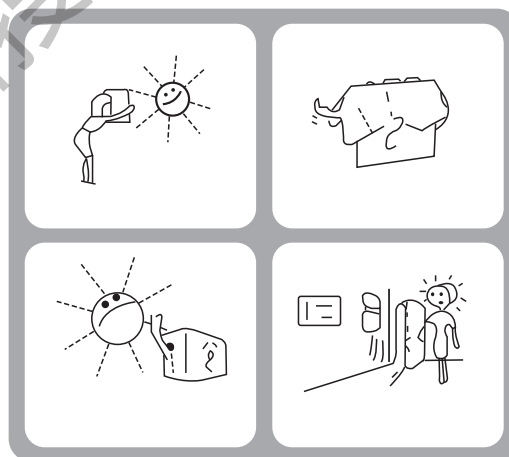



售後服務和保證事項

請服務人員檢修以前，請先依下列各項檢查

狀況	請檢查以下幾點
<p>不能運轉時</p>	<ul style="list-style-type: none"> ● 保險絲是否熔斷？ ● 電壓是否過高或過低？ ● 電源開關是否設在“ON”的位置？
<p>冷氣不冷時</p>	<ul style="list-style-type: none"> ● 濾塵網是否太髒？ ● 陽光是否直射在室內機上？ ● 室外機的空气流通是否受阻？ ● 房門或窗口是否開著或是否室內有其他熱源？ ● 設定溫度是否適當？



注：

- 在穩靜操作期間，或當停止運轉時，有時會發生下述現象。但這些都不是不正常的現象。
 - (1) 冷卻動作中會聽見冷凍劑流動的微小聲音。
 - (2) 風扇罩受熱或受冷時所發出的微小摩擦聲。
- 冷氣機有時會發出異味，但這並非不正常的現象，而是因為煙，食物，化妝品等所發出的異味附著在上面的緣故。所以最好經常清理濾塵網和蒸發器部份以減少異味。

- 上述各項檢查調整後，冷氣機仍舊不能正常運轉的話，請立刻通知購買的經銷商，並請將保證書上所記載的冷氣機形式，製造號碼，安裝日期及冷氣機故障狀況告訴經銷商。
- 電源軟線應連接在適當的定額電壓，否則機器將會損壞或不能達到預定的效能。

