



SPLIT-TYPE AIR CONDITIONER
分體挂壁式房間空調器

使用安裝說明書

OPERATING AND INSTALLING INSTRUCTIONS

R410A

制品名

MSZ-YE18VA-H1

目 錄	
安全事項.....	1
各部件名稱.....	3
操作前的準備工作.....	5
“I FEEL...”（體感...）自動運轉.....	6
選擇運轉模式時（制冷、除濕、制熱）...	7
動態地面測溫控制操作.....	8
動態地面測溫傳感器的測溫方向設定.....	9
風速・風向的調節.....	11
涼感控制運轉.....	12
睡眠模式運轉.....	13
定時器運轉（定時開・定時關）.....	14
空調機長期不使用時.....	14
維護.....	14
前面板的清掃.....	15
過濾網的清掃.....	15
在請維修人員之前，請再次檢查以下項目.....	16
當您認為「發生故障」時.....	16
移機・檢查.....	17
安裝安全事項.....	17
安裝說明.....	20
技術規格.....	26

CONTENTS	
Safety precautions.....	27
Part name.....	29
Preparation before operation.....	30
"I FEEL..." Auto Operation.....	32
Manual operation (Cooling, Dry, Heating).....	33
"MOVE EYE"CONTROL OPERATION.....	34
AREA SETTING.....	35
Air flow velocity and direction adjustment.....	37
Econo Cool operation.....	38
Sleep operation.....	39
Timer operation (OFF TIMER-ON TIMER).....	40
When the air conditioner is not used for a long time.....	40
Maintenance.....	40
Front panel cleaning.....	41
Filter Cleaning.....	41
Please check the following items before connecting a serviceman.....	42
When you think trouble occurs.....	42
Removal and inspection.....	43
Safety precautions for Installation.....	43
Installation instructions.....	46
Specifications.....	52

請不要將空調器電源插頭與其它自發供電設備連接。
如果連接將可能造成空調器損壞。

- ⚠ 警告 如果處置錯誤，造成死亡、重傷結果或財產損失的可能性很大。
- ⚠ 注意 如果處置錯誤，可能造成空調機不能正常使用或造成損失。

安裝結束後，請安裝人員務必在安裝結算聯和保修卡上按要求的貼好條形碼。

非常感謝您選用三菱電機房間空調器。
 • 為了確保正確安全地使用本機，在使用前，請一定先閱讀說明書。閱讀以後請妥善保存，以備必要時查閱。
 • 購買機器時，須在出售店收取記載有「購買日期・店名」的有效證明。
 • 顧客請不要自己安裝機器（自行安裝，將不能保證安全和功能，由此引起的安全問題本公司不予負責。自行安裝機器的售後服務不屬於三包範圍）。

安全事項

- 使用前，一定請先詳讀此「安全事項」。
- 這裏所示的注意事項，是一些有關安全的非常重要的內容，一定要遵守。

文中所用“圖符號”的意思如下

- | | |
|------------------------------|-----------------|
| ⊘ : 絕對不可做。 | ⚠ : 有觸電的危險請小心。 |
| ❗ : 一定請按指示做。 | 🔌 : 一定請拔下電源線插頭。 |
| 🚫 : 禁止插進指頭或棒條等。 | 🔌 : 一定請關閉電源。 |
| 🚫 : 禁止踩到室內/室外機組上面或在它們上面堆放東西。 | 🔌 : 一定要接地線。 |

- 閱讀后，請收藏在使用者容易發現的地方，以便參考。
- 兒童或虛弱者必須在監護人協助下才可使用本空調器。

⚠ 警告	
⊘	<p>禁止在電源線的中途引綫或延長電源綫及禁止使用多孔插座。</p> <ul style="list-style-type: none"> • 可能因接觸不良、絕緣不良、超過容許電流量而會引起火災、觸電事故。 <p>禁止損傷電源綫或作連接加工等。</p> <ul style="list-style-type: none"> • 若在電源綫上堆放重物，以及損傷、或加熱連接加工電源綫，便有可能損壞電綫引起火災或觸電事故。 <p>運轉中，禁止拔下電源插頭。</p> <ul style="list-style-type: none"> • 可能產生火花，引起火災事故。 • 用遙控器關閉室內機組后，一定請關閉保護開關或安全拔下電源插頭。 <p>不要長時間讓冷風直吹肌膚。</p> <ul style="list-style-type: none"> • 可能會損害身體健康。 <p>不要自己安裝機器。</p> <ul style="list-style-type: none"> • 因為若安裝不當，將可能引起火災、觸電、機器掉落傷人或漏水。請與出售店或技術服務中心聯系。 <p>禁止在放置或使用揮發性、腐蝕性、可燃性化學制品的環境中使用空調。</p> <ul style="list-style-type: none"> • 在室內使用揮發性、腐蝕性、可燃化學制品（如二甲苯、香蕉水、甲醇等）期間，必須禁止使用空調。 • 室內裝修油漆未干，必須打開門窗，進行通風，等房間內各種稀釋劑氣體揮發散盡，方可使用空調。否則會引起機器腐蝕，變形，甚至引起火災。 <p>禁止燃燒器具放在直接吹得到風的地方。</p> <ul style="list-style-type: none"> • 可能引起燃燒器具的不完全燃燒。 <p>禁止用殺蟲劑·消毒劑·可燃性噴霧材料噴吹。</p> <ul style="list-style-type: none"> • 可能引起火災、變形。 <p>安裝臺如果已陳舊不堪，不可置之不理。</p> <ul style="list-style-type: none"> • 機組有翻倒傷人的可能。 <p>保養機組時，禁止站在不穩固的腳臺上。</p> <ul style="list-style-type: none"> • 可能跌倒受傷。 <p>禁止拉電源綫。</p> <ul style="list-style-type: none"> • 要卸下電源綫時，必須抓住插頭拔下。因為可能拉斷電源綫中的一部分芯綫而引起火災事故。
⊘ 🚫	<p>禁止在進風口、排風口或出風口插入手指或棒條等。室內機安裝高度應保證風葉葉片高于地面2.3米以上。</p> <ul style="list-style-type: none"> • 裏面有高速旋轉的風扇，會造成人身傷害。 • 應看好兒童，切勿讓他們玩弄空調器。
🔌 ⚠	<p>發覺異常時（有糊味等），應立刻停止運轉，拔去電源插頭并關閉電源開關。</p> <ul style="list-style-type: none"> • 發覺異常而繼續運轉下去時，可能導致火災、故障等。此時，請與出售店或技術服務中心聯系。
❗	<p>清除電源插頭上的灰塵，接插穩固。</p> <ul style="list-style-type: none"> • 若附着灰塵，或沒有插好，便有引起火災、觸電的可能。 <p>和燃燒器具一起使用時，應該時常換氣。</p> <ul style="list-style-type: none"> • 可能產生氧氣不足的現象。 <p>長期不使用機器時，應拔下電源插頭。</p> <ul style="list-style-type: none"> • 因堆積灰塵而有可能引起火災和事故。
🚫	<p>禁止踩在室內/室外機組上或在上面堆放東西。</p> <ul style="list-style-type: none"> • 可能跌下受傷或機器掉落傷人。
	<p>不可自己修理或移機。</p> <ul style="list-style-type: none"> • 因為處理錯誤，可能導致火災、觸電、機器掉落傷人或漏水等。請與出售店或最近技術服務中心聯系。 • 如果電源綫損壞，必須由制造商或服務商更換，以避免損失。

安全事項

⚠ 注意	
⊘	在拆卸過濾網時，小心不要碰到室內機組的金屬部分。 • 有被刮傷的可能。
	禁止在直接吹到空調機氣流的地方放置動植物。 • 可能對動植物有不良影響。
	禁止給電池充電或拆卸電池，禁止投入火中。 • 可能導致電池漏液、火災或爆炸。
	禁止開放着門窗，在高濕度狀況下作長時間的運轉。 • 開冷氣時，若在高濕度（80%以上）下作長時間連續運轉，空調機可能有冷凝水滴下，浸濕污損室內家具。
	禁止當其他特殊用途。 • 不能作為保存精密機器、食品、動植物、美術品的用途。因為有降低保存品質量的可能。
!	打掃時，應停止運轉，拔下電源插頭或關閉電源開關。 • 運轉中，有高速旋轉的風扇可能傷人。
	更換相同類型的2節新電池。 • 新舊電池混用可能導致電池發熱、漏液或爆炸。
	如果電池液沾到皮膚或衣服，請用清水仔細清洗。 • 如果電池液不慎濺入眼睛，請用清水衝洗並立刻就醫。
⚡	禁止用潮濕的手去操作開關。 • 有觸電的危險。
	禁止用水洗刷空調機。 • 機器中如果進水，會降低絕緣性能，有發生觸電的危險。

安裝機器

⚠ 警告	
• 安裝機器，請與購買機器的出售店或技術服務中心聯繫。	

⚠ 注意	
⊘	禁止安裝在有可能泄露腐蝕性、可燃性氣體的地方。 • 萬一氣體泄露並聚集在機組周圍時，便有發生爆炸或損壞機器的危險。
	室內外機組下面不得堆放其它電器產品及家具等。 • 因會有水滴滴下的情況，導致污損和設備故障。
⚡	必須接地線。 • 空調插座應連接有專門接地線，地線切勿接到煤氣管、自來水管、避雷針導線、電話接地線上。如果沒有接地線或地線沒有連接好，可能引起觸電事故。在使用前請務必確認是否有接地線和接地線是否按要求連接。
!	某些安裝場所（例如濕氣高的地方等），必須安裝漏電斷路器。 • 若不裝漏電斷路器，便可能有觸電的危險。
	排水口須保證能順利排水。 • 如果有排水不良狀況，機組將可能滴水浸濕污損家具。

各部件名稱

室內機組

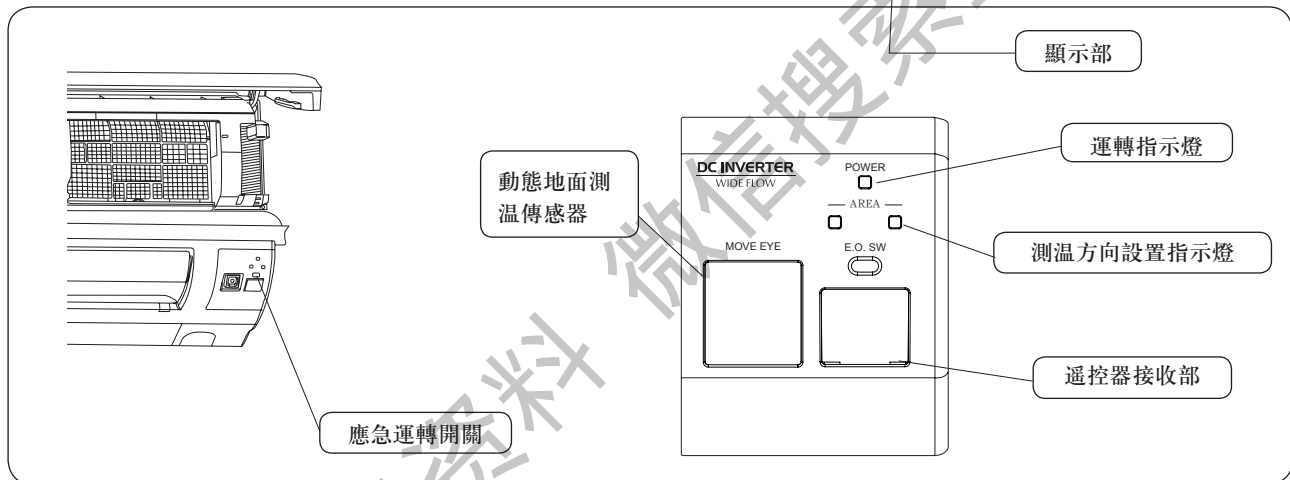
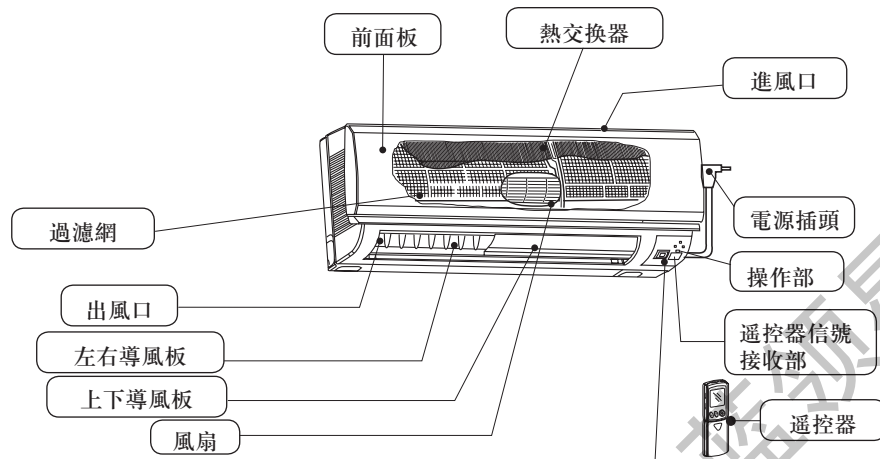

室外機組

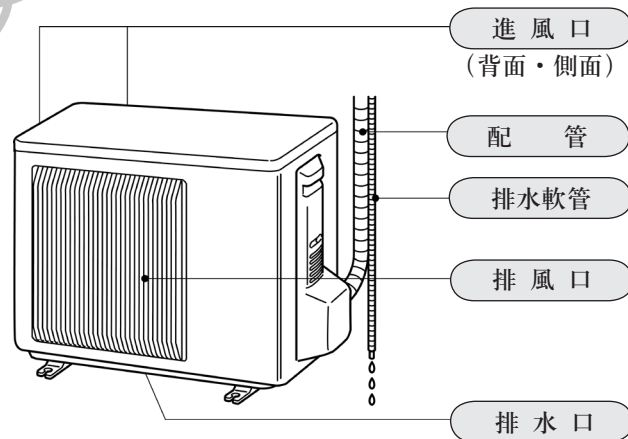

各部件名稱

遙控器

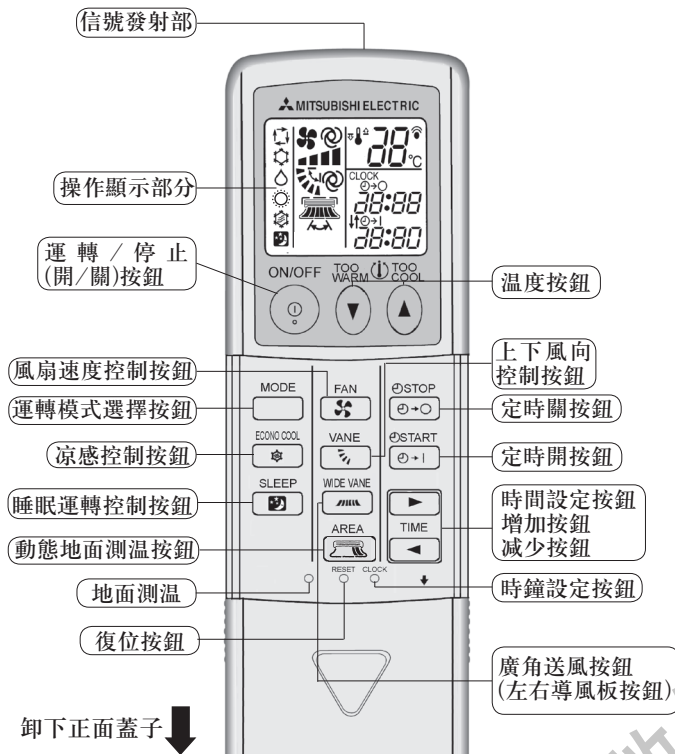

如何安裝電池及設定當前時間

- 1 移去前蓋，裝入電池。重新裝好前蓋板。
先插入電池的負極。檢查電池的極性是否正確。

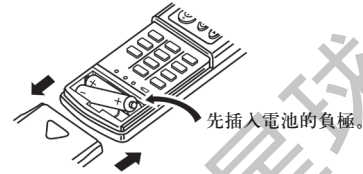

- 2 按下復位按鈕。
用尖細東西按下。
• 如果復位按鈕未按下，遙控器不能正常使用。
• 注意按下時不要太過用力。
- 3 按下時鐘設定按鈕。
用尖細東西按下。
- 4 按下▶(增加)與◀(減少)按鈕(時間設定按鈕)，設置當前時間。
• 每按下一次前進按鈕▶，時間增加1分鐘。每按一次后退按鈕◀，時間減少1分鐘。
• 長時間按住按鈕，設定時間會以10分鐘等級增加/減少。
- 5 再次按下時鐘設定按鈕，并合上前蓋板。

重要設定

動態地面測溫傳感器使用前遙控器的設定

- 在遙控器電池盒內請將滑動開關撥到適當位置 (要求和室內機安裝的空間位置一致)
如果這個開關沒有設定正確，那么空調器可能不能達到最佳的運行狀態。

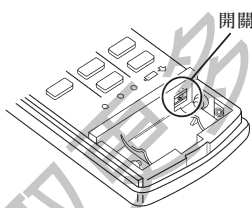

(安裝位置)	左	中	右
開關的位置	左.中.右	左.中.右	左.中.右
遙控器的顯示			

室內機組安裝在房間的哪個位置?

安裝在左面 (要求距離50cm以內) 安裝在中間 安裝在右面 (要求距離50cm以內)

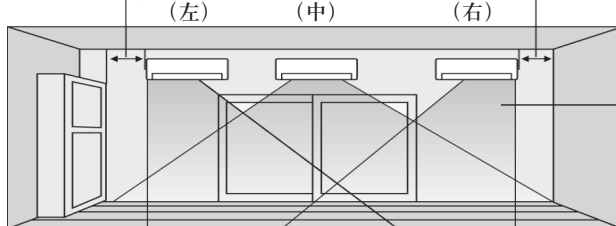

室內機組是安裝在左面、右面、中間?

注：如果室內機組安裝在距離側面牆壁或櫥櫃或其他附近對象超過50cm時，設定此開關在“中間”位置。

操作前的準備工作

遙控器的使用方法

- 信號可到達範圍是對着室內機組正面的直線距離6米以內。
- 按下按鈕時，室內機組將發出“嗶”或“嗶嗶”收到信號的聲音。
如果沒此響聲，請再作一次按鈕操作。
- 遙控器必須小心使用。如果它掉落地上，拋擲或浸了水，就可能出現不能發送信號的情況。

電池

■ 更換電池的標準

以下情況需要更換兩節新7號鹼性電池(LR03):

- 室內機組對遙控器信號無反應時。
- 遙控器上的顯示器變淡時。
請勿使用錳電池。遙控器會發生故障。
- 鹼性電池壽命大約1年。但要考慮干電池底面的建議期限(年/月)。如果接近期限，則必須盡早更換電池。
- 為防止漏液，長期不使用遙控器時請將電池取出。

△ 注意:

- 如果電池液沾到皮膚或衣服，請用清水仔細清洗。
如果電池液不慎濺入眼睛，請用清水衝洗並立刻就醫。
- 請勿使用充電電池。
 - 2節電池須屬同種電池。
 - 廢舊電池應妥善處理。

遙控器不能使用時（應急運轉）

當遙控器的干電池電量耗盡，或遙控器發生故障時，可利用本機上的應急運轉開關控制運轉。

1 按下應急運轉開關。

- 每按下一次按鈕，即按照制冷→制熱→停止模式的順序變化。

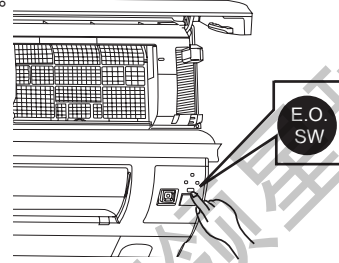

- 運轉模式由室內機組上的操作指示燈指示。如下圖所示。
操作指示燈

應急制冷	測溫	操作指示燈
亮	減	☀ L R □
應急制熱 <th>測溫</th> <td>□ L R ☀</td>	測溫	□ L R ☀
減	亮	
停止 <th>測溫</th> <td>□ L R □</td>	測溫	□ L R □
減	減	

△ 注意:

這是在應急模式下的顯示內容。
在應急模式下測溫方向的設定無效。

- 運轉內容如下。
在最初的30分鐘內不受房間溫度影響只連續運轉，風速恒定。
運轉30分鐘后狀態如下：

運轉模式	制冷	制熱
設定溫度	24℃	24℃
風速	中	中
上下導風板	自動	自動
左右導風板	前	前

自動重新啓動功能

- 該機型具有自動重新啓動功能，但在工廠出貨時，此功能設為關閉。如您需要使用自動重新啓動功能，請與技術服務中心聯系。

自動重新啓動功能就是...

當使用遙控器控制室內機組時，機組自動記憶運轉模式，設定溫度和風扇速度。如果運轉過程中發生斷電或關閉了主電源，當電源恢復后“自動重新啓動功能”會自動啓動機器并以斷電前用遙控器設定的模式運轉。

室內機組

將電源插頭插入插座，將電源開關推到開的位置。

△ 警告:

須清除電源插頭上的灰塵，確認接插穩固。
如果附着有灰塵或插座不良時，將有發生火災，觸電的危險。

2 要停止時，請按下應急運轉開關，設定為停止。

- 每按下一次按鈕，即按照制冷→制熱→停止的順序變化。

“I FEEL...” (體感...) 自動運轉

“I(體感...)”自動運轉模式下，一次操作就可自動使室內環境條件達到最佳狀態。

開始體感自動運轉時

■按下  按鈕。

顯示  (自動運轉)時，空調器自動控制為最適當溫度。

要停止時

■請按下  按鈕。

開始運轉后大約經過15分鐘：

如果感到太熱：







■按下  按鈕降低溫度。

每按一次，大約下降1℃。

如果感到太冷：

■按下  按鈕升高溫度。

每按一次，大約上升1℃。

不顯示“ (體感...)”自動運轉時，請按  按鈕以設定自動運轉模式。
每按一次，運轉模式即按照 (自動運轉)→ (制冷)→ (除濕)→ (制熱)的順序變化。

(自動運轉...) 模式

自動運轉的結構

根據開始運轉時的室溫，運轉模式自動設定為制冷、除濕或制熱。但在停機后2小時以內再運轉時，則將與上次運轉進行同樣內容的運轉。一旦設定好運轉內容后，室溫雖有變化也不受影響。運轉內容如果不喜歡，可按下  按鈕，再選擇適當的運轉內容。

體感自動運轉內容

開始運轉時的室溫	運轉模式	目標溫度 (初始狀態)
大約25℃以上	制冷	大約24℃
大約25℃以下	除濕	-
大約23℃以下	制熱	大約26℃

注：

制冷：當室溫高于設定溫度2℃時，設定溫度不會變化，因為空調器正在運轉到達目標(設定)溫度。此時，請等待室溫降至設定溫度附近2℃以內，然後改變設定溫度。

制熱：當室溫低于設定溫度2℃時，設定溫度不會變化，因為空調器正在運轉到達目標(設定)溫度。此時，請等待室溫升至設定溫度附近2℃以內，然後改變設定溫度。

選擇運轉模式時（制冷、除濕、制熱）

選擇運轉模式時(制冷、除濕或制熱模式):

1 請按下  按鈕。

2 按下  按鈕選擇運轉模式。

每次按下按鈕，運轉模式即作(自動運轉)→(制冷)→(除濕)→(制熱)。

要停止時:

請按下  按鈕。

運轉模式設定，以後只要按  按鈕，空調機即以設定模式進行運轉。

要改變設定溫度時:

- 要降低溫度時，請按下  按鈕。按一次，大約下降1℃。
- 要升高溫度時，請按下  按鈕。按一次，大約升高1℃。

除濕運轉時

- 不能進行溫度控制(溫度設定)。
- 以稍低於室溫的溫度進行運轉。

注:

- 環境溫度太高時，因為制冷運轉負載太大的關係。室內溫度可能無法達到設定的溫度。
- 熱泵型空調器原理：機器通過冷媒循環從室外空氣中吸收熱量並將其傳送到室內從而加熱房間內的空氣，其制熱的能力隨室外氣溫降低而下降。
- 如室外溫度變得很低，請與其它取暖設備一起使用。

使用空調須知

制冷 如何讓制冷運轉更有效率

- ① 關緊窗戶，放下窗簾，減小日照量。
- ② 在窗玻璃上貼市售的熱綫遮蔽用薄膜，也可以減少陽光進入室內的熱量。
- ③ 室外機組安裝在不易受太陽直射的地方。

制熱 有益健康的暖和度，其關鍵是和外界的溫度差！

要進行制熱運轉時的溫度設定，應和外界溫度不要相差太大。雖然隨地區而有不同，但是，一般可把設定溫度定在20℃—24℃。

除濕 70%是人們感覺舒適的濕度分歧點。

人覺得悶熱時，是因為空氣中的水蒸汽含量多，即濕度高的關係。濕度與溫度、風都有關係。一般認為人感到最舒適的濕度條件是夏季60%~75%，冬季55%~70%。

動態地面測溫控制操作...智能化的溫度控制方式

- 本空調器對溫度的調節控制（“智能化的溫度控制”）是除了檢測房間溫度以外還同時檢測地面/牆面的輻射溫度從而使得空調器進行綜合調節控制的過程（“動態地面測溫控制操作”）。
- 取消動態地面測溫控制操作后以往的房間溫度控制方式代替智能化的溫度控制。

開始動態地面測溫控制時

- 在手動冷房或手動暖房的模式下，用尖細東西按下遙控器上地面測溫按鈕。

注意：

這個動態地面測溫控制操作模式是有記憶的（即使交換電池或按下復位按鈕），當遙控器初次使用時要進行設定，再使用時根據前次設定方式進行運轉。

解除動態地面測溫控制時

- 再一次用尖細東西按下遙控器上地面測溫鈕。

注意：如果此空調器是關機狀態則不能取消動態地面測溫控制操作，必須在運行狀態下進行解除該模式的操作。

動態地面測溫控制操作

本傳感器經常測溫地面/牆面的輻射溫度，通過估計溫度（實際上是對房間內部人體的感知）自動地調整設定溫度。（“智能化的溫度控制”）

優勢

- 房間內很快形成舒適的環境。
- 當空調器保持長時間運轉時，房間內將不會感覺太冷或太熱。

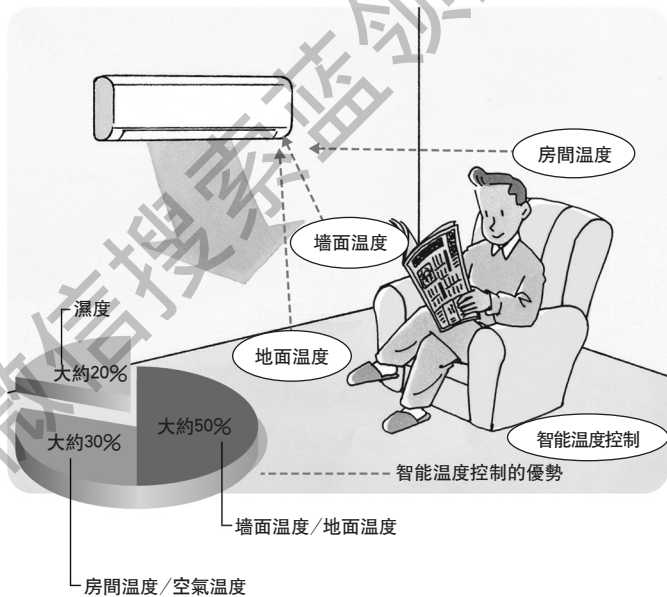

動態地面測溫傳感器

- 當測溫方向設定記憶取消時，根據空調器安裝位置的不同方位動態地面測溫傳感器檢測範圍也不同。

安裝位置	安裝在左面	安裝在中間	安裝在右面
檢測範圍圖示			
傳感器檢測方向	右面	中間	左面

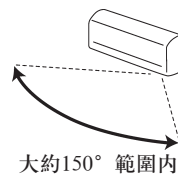



請查閱第4頁說明(遙控器電池盒內滑動開關設定)

- 這個測溫方向設定是有記憶的(前次設定狀態)，這個全方位測溫傳感器在150°的範圍內(三種安裝空間之一，左面/中間/右面)檢測地面/牆面的輻射溫度，因此，檢測到的溫度可能會不同，由於標準溫度(接近于市售溫度計所測值)是依靠接近房間或接近地面和/或牆面的溫度來分類。
- 保養或維修之后請正確安裝前框組件，這樣才能正確地檢測地面/牆面輻射溫度。

動態地面測溫傳感器的測溫方向設定







在測溫方向設定時，水平空氣流動的方向(左右導風板)將根據傳感器檢測地面/牆面的輻射溫度來自動調節。

開始測溫方向設定時

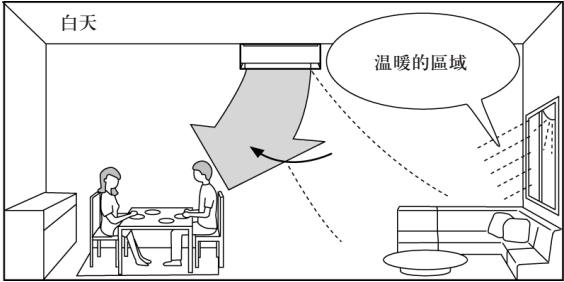
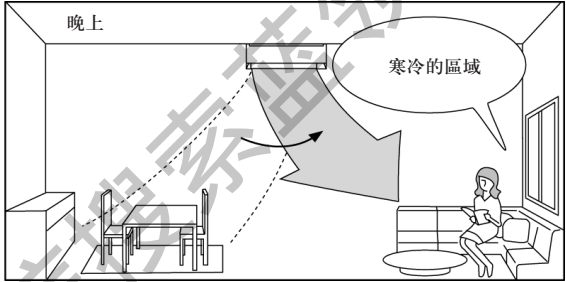
- 按下“測溫方向”按鈕
 - 連續按該按鈕，顯示是按下列順序變化。
自動  → 左面  → 右面  → 取消(恢復設定前的設置)。
- 這個動態地面測溫傳感器間歇地轉動來檢測地面和牆面的輻射溫度。

注意：

- 測溫方向設定只有在動態地面測溫控制操作時才有作用。(查閱第8頁)
- 如果這個測溫方向設定被取消，左右導風板將返回測溫方向設定前的設置。
- 水平空氣流動方向(左右導風板)，在測溫方向設定使用時將不能手動設置。

<p>左右風向的移動</p>	<ul style="list-style-type: none"> • 如果測溫方向設置是設定在制熱操作時，當室內地板和牆面的輻射溫度較低時室內機組會自動的在該區域內輸送溫暖的風。 • 如果測溫方向設置是設定在制冷操作時，當室內地板和牆面的輻射溫度較高時室內機組會自動的在該區域內輸送涼爽的風。 <p>例：在制熱操作時</p> <div style="display: flex; justify-content: space-around;"> <div data-bbox="224 743 792 1026"> <p>白天</p>  </div> <div data-bbox="829 743 1398 1026"> <p>晚上</p>  </div> </div> <p style="text-align: center;">室內機組在房間內檢測到寒冷的區域時會輸送溫暖的風。</p>
<p>室內機組顯示</p>	<p>測溫方向設定顯示</p> <div style="display: flex; justify-content: center; gap: 20px;"> <div style="text-align: center;"> <p>左</p>  L </div> <div style="text-align: center;"> <p>右</p>  R </div> <div style="text-align: center;"> <p>左</p>  L </div> <div style="text-align: center;"> <p>右</p>  R </div> </div> <div style="display: flex; justify-content: center; gap: 20px; margin-top: 5px;"> <div style="text-align: center;"> <p>亮</p> </div> <div style="text-align: center;"> <p>滅</p> </div> <div style="text-align: center;"> <p>滅</p> </div> <div style="text-align: center;"> <p>亮</p> </div> </div>
<p>注意</p>	<ul style="list-style-type: none"> • 如果這個動態地面測溫傳感器檢測到大約有3°C溫度差異時那水平空氣的流動方向(左右導風板)將改變。 • 測溫方向設定在自動檔時，當房間溫度是較均勻時左/右兩個顯示燈都點亮。 <div style="display: flex; justify-content: center; gap: 20px; margin-top: 10px;"> <div style="text-align: center;"> <p>左</p>  L </div> <div style="text-align: center;"> <p>右</p>  R </div> </div> <div style="display: flex; justify-content: center; gap: 20px; margin-top: 5px;"> <div style="text-align: center;"> <p>亮</p> </div> <div style="text-align: center;"> <p>亮</p> </div> </div>

測溫方向設定的解除

- 按下測溫方向按鈕(選擇取消)
- 在測溫方向設置期間當左右風向按鈕按下時，測溫方向設置將解除。

室內機組安裝的位置和空氣調節的空間

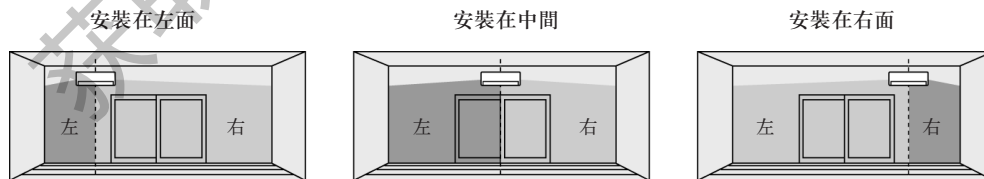

- 確認遙控器內滑動開關的設定位置一定要與室內機組安裝的位置一致。如果這個開關設定不正確，那么將影響空調器的使用功效。(查閱第4頁)

動態地面測溫傳感器的測溫方向設定

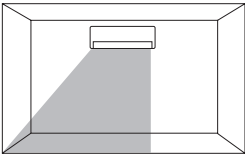
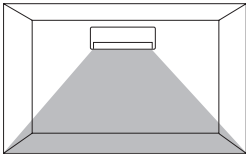
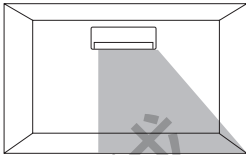
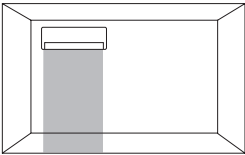
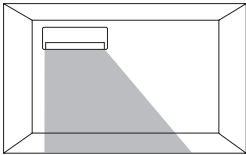
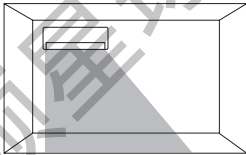
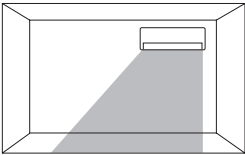
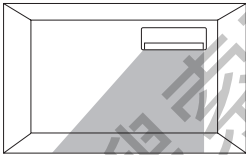
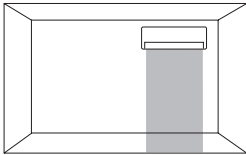
測溫方向設置		優先對房間內左側空氣調節。	對整個房間空氣調節。	優先對房間內右側空氣調節。
遙控器按鈕		按下測溫方向按鈕（選擇左側）	按下測溫方向按鈕（選擇自動）	按下測溫方向按鈕（選擇右側）
左右風向的控制範圍 (上下風向的位置不變)	安裝在中間			
	安裝在左面			
	安裝在右面			
室內機顯示	測溫 亮	測溫 亮	測溫 亮	測溫 亮
測溫方向	☀ L R □ 亮 滅	☀ L R □ 或 ☀ L R □ 或 □ L R ☀ 亮 滅 亮 亮 滅 亮	☀ L R □ 或 ☀ L R □ 或 □ L R ☀ 亮 滅 亮 亮 滅 亮	☀ L R □ 滅 亮

獲取更多資料

風速・風向的調節

選擇喜歡的風速及風向。







■要改變風速時，請按下  按鈕。

每次按下按鈕，即按照 (弱)→ (中)→ (強)→ (超強)→ (自動)的順序改變風速。

風速的選擇方法：

本空調原理上：風量越大，節能效果越好，噪音也越高，制冷時出風溫度升高，制熱時出風溫度下降。因此，選擇（弱）檔可獲得一個安靜的休息環境，選擇（強）或（超強）檔可得到好的節能效果。

■要改變上下的風向時，請按下  按鈕。

每次按下按鈕，即按照→ (1)→ (2)→ (3)→ (4)→ (擺動)→ (自動)的順序改變上下風向。



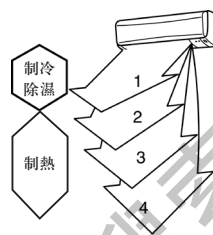

擺動送風

擺動運轉可使氣流到達整個房間。

上下風向的推薦範圍
平常請用 (自動)。

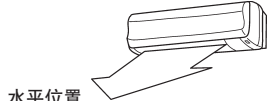
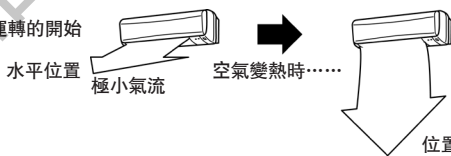

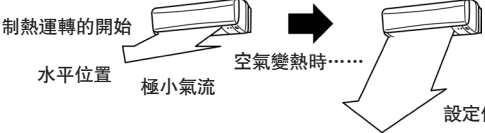
上下導風板的移動

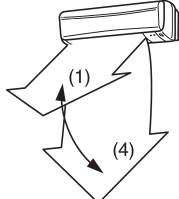
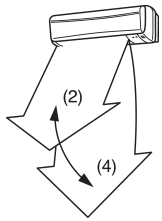





	制冷/除濕	制熱
自動 	 <p>水平位置</p> <ul style="list-style-type: none"> 導風板停止擺動后自動移動至水平位置。 注：氣流高于位置(1)。 	 <p>制熱運轉的開始 水平位置 極小氣流 空氣變熱時…… 位置(4)</p> <ul style="list-style-type: none"> 空調機開始運轉后，導風板停止在水平位置。一旦室內機組出來的氣流溫度够高，導風板移動至位置(4)。 一旦空調機開始運轉，風扇速度隨室內機組出來的氣流溫度變熱而逐漸增加，直至到達設定速度。
手動 	 <p>0.5至1小時后 位置(1)或(2)</p> <p>風向設定為位置(2)、(3)或(4)</p> <ul style="list-style-type: none"> 運轉大約一小時后，空調機自動把導風板移動至位置(1)或(2)。要將風向改回原始設定，請再操作遙控器上的導風板按鈕。 	 <p>制熱運轉的開始 水平位置 極小氣流 空氣變熱時…… 設定位置</p> <ul style="list-style-type: none"> 空調機開始運轉后，導風板停留在水平位置。一旦室內機組出來的氣流溫度够高變得够熱，導風板移動至對應氣流設定方向的位置。 一旦空調機開始運轉，風扇速度隨室內機組變熱而逐漸增加，直至最后到達設定速度。
擺動 	 <p>(1) (4)</p> <ul style="list-style-type: none"> 導風板在位置(1)和(4)間間歇移動。導風板在位置(1)和(4)上停留片刻。 	 <p>(2) (4)</p> <ul style="list-style-type: none"> 導風板在位置(2)和(4)間間歇移動。導風板在位置(2)和(4)上停留片刻。

注：

- 請用遙控器調節風向。用手移動上下和左右導風板可能造成故障。
- 運轉模式改變至 (自動) 模式時，上下導風板自動改變至各模式中的位置。

風速・風向的調節

使氣流不直接吹到身體上。

要改變風向	何時使用此功能?	制冷 / 除濕	制熱
按住  按鈕2秒鐘后，上下導風板移動至水平位置。  水平位置	如果不想室內機組氣流直接吹到身體上，可使用此功能。 <ul style="list-style-type: none"> • 根據房間形狀，氣流可能直接吹到身體上。 • 再次按下  按鈕，導風板返回前一設定位置。 	導風板移動至水平位置約3分鐘后空調機開始制冷或除濕運轉。 <ul style="list-style-type: none"> • 再次按下  按鈕時，導風板返回前一設定位置，約3分鐘后空調機開始制冷或除濕運轉。 	導風板移動至水平位置約3分鐘后空調機開始制熱運轉。 <ul style="list-style-type: none"> • 有時地面區域可能不够熱。要加熱地面區域，將上下導風板設定為 (自動)或下吹位置。 • 再次按下  按鈕時，導風板返回前一設定位置，約3分鐘后空調機開始制熱運轉。

注：

- 如果按下  按鈕使氣流不會直接吹到身體上，空調機運轉中壓縮機會停止3分鐘。
- 空調機風量會減少，直至壓縮機再次開啓。

■要改變左右風向，請按下  按鈕。

每次按下按鈕，左右導風板角度按照以下順序變化：



擺動送風

使用擺動送風可使風到達房間每個角落。

涼感控制運轉

要享受健康舒適、省電的制冷運轉時，請使用此模式。





在手動制冷模式運轉中，請進行以下操作。

■按下  按鈕。

選擇以  (涼感) 控制模式運轉的空調機，將根據空調機出風口溫度控制上下導風板作周期性地自動擺動。另外，設定溫度也從制冷運轉時自動升高2℃。

要解除涼感控制運轉：

■請再按一次  按鈕。

- 在涼感控制運轉中，按下  按鈕或改變運轉模式，涼感控制解除。
-  按鈕、 或  按鈕及定時開 / 關按鈕可繼續使用。





什么叫“涼感控制”？

擺動氣流（氣流變化）比恒定氣流更為涼爽。因此即使設定溫度自動設定為高2℃，也能得到舒適感。從而節省了電力。



睡眠模式運轉

要休息時，請在制冷模式中選擇此功能。

要選擇睡眠模式時

- 1 機組運轉時按下  按鈕。
風扇速度改變為自動。當改變風扇速度時，睡眠模式取消。
- 2 按下  按鈕或  按鈕設定睡眠模式溫度。
設定睡眠模式溫度后，再次按下  按鈕會顯示前一模式設定的溫度。

要解除睡眠模式

- 再次按下  按鈕。
按下 、 按鈕或改變運轉模式也能解除睡眠模式。
睡眠模式可與定時開 / 關結合使用。

睡眠模式說明

按下  按鈕時，顯示部變暗，風扇速度自動轉為自動模式，空調器低噪音運轉。
• 以睡眠模式運轉時，有時空調器制冷或制熱力度不夠。這時，可解除睡眠模式。

制冷 / 制熱模式

- 空調機以按下睡眠按鈕前設定的溫度運轉大約30分鐘，然後切換至睡眠模式所設定的溫度。

設定溫度改變

按下睡眠按鈕前設定的溫度（大約30分鐘）

↑ 按下  按鈕

睡眠模式
設定溫度

睡眠模式設定溫度
制冷模式中，建議將溫度設定為比當前溫度稍高1℃至2℃，避免睡眠中着涼。制熱模式中，建議將溫度設定為比當前設定的溫度低5℃至6℃睡得舒適。

如果使用定時開啓動睡眠模式，空調器在睡眠模式所設定的溫度上開始運轉。

定時開設定溫度

睡眠模式設定溫度







↑ 定時開結合睡眠
模式。

遙控器初始設定溫度
如果更換電池后遙控器復位，初始溫度設置如下：
制冷睡眠模式：28℃
制熱睡眠模式：17℃

定時器運轉（定時開・定時關）

可預設在就寢后或您回家時或起床時開／關空調器。

如何設置定時開

- 1 按下  按鈕。
按定時開按鈕 “” 圖形閃爍。
- 2 使用時間按鈕 （增加）和 （減少）設定定時器時間。
每按一下  按鈕，設定時間增加10分鐘；每次按一下  按鈕，設定時間減少10分鐘。

解除定時開







- 1 請按下  按鈕。

定時開・定時關結合使用時

定時開和定時關結合使用。先到的設定時間先運轉。
（“↑↓”標記指示定時器的運轉順序）
• 如果未設定當前時間，定時器運轉可能不能使用。

注：
如果定時器運轉時主電源關閉或發生電源故障，定時器設定取消。

如何設置定時關

- 1 按下  按鈕。
按定時關按鈕 “” 圖形閃爍。
- 2 使用時間按鈕 （增加）和 （減少）設定定時器時間。
每按一下  按鈕，設定時間增加10分鐘；每次按一下  按鈕，設定時間減少10分鐘。

解除定時關

- 1 按下  按鈕。

空調機長期不使用時

長期不使用時

- 1 實施風扇運轉3~4小時，讓空調機內完全干燥。
• 要進行風扇運轉時，請設定為送風運行模式并選擇最高設定溫度。
- 2 關掉電源開關然後拔掉電源綫插頭。

△ 警告：
空調機長期不使用時拔下電源插頭。
因為可能堆積灰塵而引起火災。
- 3 取出遙控器中的電池。

△ 注意：
為防止漏液，遙控器長期不使用時取出所有電池。

要再開始使用時

- 1 清掃過濾網并裝回本機。
（清掃的方法，請參見第15頁）
- 2 室內及室外機組進風口、排風口須確認是否被遮蔽了。
- 3 確認接地綫是否牢固。

△ 警告：
要接地綫。
地綫不可接在煤氣管、自來水管、避雷針、電話綫上面。
若不按要求接地綫，可能有觸電危險。

維護

清掃之前

- 1 關閉電源開關然後拔下電源插頭。



△ 警告：
清掃時，必須停止運轉，拔下電源插頭并關掉電源開關。
因為運轉中，高速旋轉中的風葉可能造成人身傷害。

室內機的清掃

- 1 用柔軟的干布清潔。
 - 如有明顯污漬，用布蘸中性清潔劑的水溶液擦拭機組。
 - 嚴禁使用汽油、揮發油、磨擦粉、或消毒劑。否則會損壞機組。
 - 前面板舉過水平位置后可能脫落。如果前面板脫落，請參考“前面板的清掃”中步驟②。

前面板的清掃

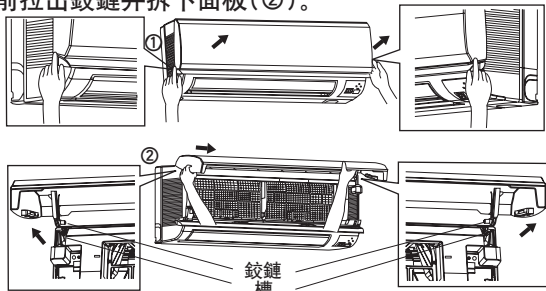
- 1** 按住并松开前面板兩端的卡扣，提起前面板，直至聽到“咔嚓”聲(①)。握住鉸鏈，水平提起前面板，向前拉出鉸鏈并拆下面板(②)。



警告：

- 不要强行抽出前面板，不要掉落，否則會造成前面板破損。
- 拆裝前面板時，不要站在不穩定臺面上，否則有可能翻倒受傷。

- 2** 用柔軟的干布擦拭或水洗。
水洗后，用柔軟干布擦干净水。

- 如果面板太髒，可用布蘸加入中性洗滌劑的溫水溶液擦拭前面板。
- 嚴禁用汽油、揮發油、混合溶劑、摩擦粉或消毒劑，請勿用刷子或硬面海綿清洗。
- 請勿長時間(兩小時以上)置于熱水中或置于直射陽光及取暖器作用範圍內，否則會導致前面板變形及變色。

- 3** 用兩手握住前面板的兩端，把前面板大致水平放置，再把鉸鏈部放入室內機最上部的槽中，直至聽到“咔嚓”聲為止。接着關上前面板，再用手按一下圖箭頭所示的三個位置。



茶精清新網的清掃

茶精清新網的清掃（以兩個星期一次為標準）

- 1** 輕輕拉出茶精清新網。

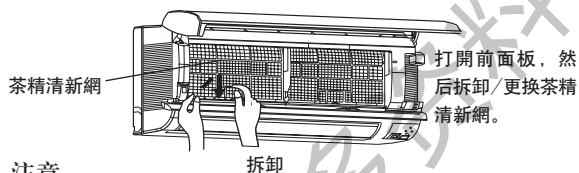

注意：

拆卸茶精清新網時，請注意別碰到室內機組的金屬部分，因為有被刮傷的可能。

- 2** 可用吸塵器清掃或用水洗滌干净。

- 禁止用刷子或硬面海綿清掃。否則茶精清新網會變形。
- 如果茶精清新網太髒，可用加入中性洗滌劑的溫水洗滌溶液洗刷。
- 禁止用熱水(大約50°C以上)清洗，以免變形。

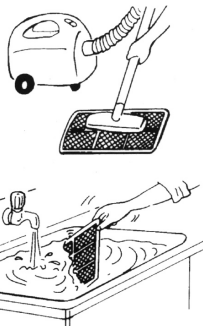

- 3** 用水洗滌過後，陰干后才能使用。

- 禁止用陽光干燥或用火烘干。

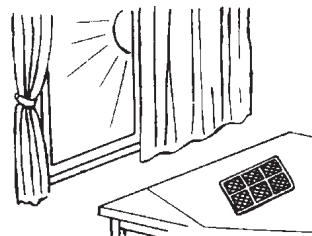

- 4** 安裝茶精清新網。

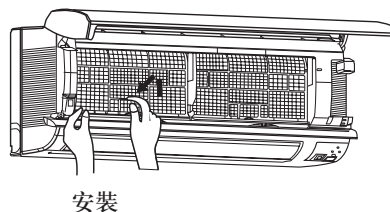

在請維修人員之前，請再次檢查以下項目

是否出了故障?	檢查點
空調機無法運轉。	<ul style="list-style-type: none"> • 電源開關是否打開? • 保險絲是否燒斷? • 是否設定了定時開?
上下導風板不動作。	<ul style="list-style-type: none"> • 上下導風板和左右導風板是否正確安裝于室內機組? • 風扇防護網是否變形?
室內無法充分制冷。	<ul style="list-style-type: none"> • 溫度設定是否正確? • 過濾網是否干淨? • 室內或室外機組的進風口或出風口是否被遮蔽? • 門窗是否打開?

是否出了故障?	檢查點
室內機組發出臭味。	<ul style="list-style-type: none"> • 過濾網是否干淨?
遙控器不顯示或變暗。室內機組對遙控器信號無反應。	<ul style="list-style-type: none"> • 電池電量是否用完? • 電池極性是否裝反? • 是否按下了其他電器遙控器上的按鈕?

檢查上述項目后空調機仍無法恢復運轉，請停止使用并與機器的出售店或技術服務中心進行聯繫。

在要求維修之前，請注意下列情況。

- 在使用電子式熒光燈的房間裏，有可能不能接受遙控信號。
- 在無線電電波弱的地方，空調機可能干擾廣播或電視接收。受影響設備可能需要放大器。
- 打雷時，請停止運轉并拔下電源插頭或關掉電源開關。否則，可能有損傷空調電氣部件的危險。

當您認為「發生故障」時

是否出了故障?	答案 (不是異常)
重新開機3分鐘內空調機仍無法運轉。	<ul style="list-style-type: none"> • 根據微型電腦的指示以保護空調機。請等待。
聽到“噼啪”聲。	<ul style="list-style-type: none"> • 由于溫度變化，前面板的膨脹/收縮產生聲音。
室內機組出來的空氣有臭味。	<ul style="list-style-type: none"> • 空調機可能吸入了牆壁、地毯、家具、衣服等的異味，再混合空氣吹出。 • 可視光觸媒過濾網是否清掃。如果可視光觸媒過濾網積滿灰塵，請清掃。
除濕運轉模式中風扇停止。	<ul style="list-style-type: none"> • 除濕運轉中，機組使用與制冷運轉相同的制冷劑回路。除濕運轉為了降低濕度而不致于降低室溫，壓縮機有時會停止，此時室內風扇停轉。這是為了防止熱交換器上的凝露水滴再次蒸發。
聽到水流聲。	<ul style="list-style-type: none"> • 這是空調機內制冷劑流動發出的聲音。 • 這是熱交換器內凝露水滴流動發出的聲音。 • 這是熱交換器解凍發出的聲音。
聽到類似氣泡的聲音。	<ul style="list-style-type: none"> • 這是開啓吸油煙機或通風扇時，從排水軟管吸入外部空氣，使排水軟管內水流噴出而發出的聲音。如果外部風力很強，外部空氣吹入排水軟管，也會聽到這種聲音。
運轉中室內機出風口吹出霧氣。	<ul style="list-style-type: none"> • 空氣中的水份遇到從室內機出風口裏吹出的冷風而迅速凝結成霧氣所至。
可從室內機組聽到“咯嗒咯嗒”聲音。	<ul style="list-style-type: none"> • 這是風扇或壓縮機開關正在切換(接通斷開)的聲音。
室內機發出“布噓!”聲。	<ul style="list-style-type: none"> • 這是空調機啓動或停止冷媒流動的聲音。

是否出了故障?	答案 (不是異常)
運轉中自行改變風向。遙控器無法調節上下導風板方向。	<ul style="list-style-type: none"> • 當空調機在制冷模式中運轉時，如果空氣向下吹持續1小時，風向自動設定為位置(1)或(2)，這是為了防止凝露水滴下。 • 制熱運轉中，如果吹出空氣的溫度較低，或是在除霜運轉時，將自動地設定水平方向吹出。
室外機組有漏水現象。	<ul style="list-style-type: none"> • 制冷運轉中，管道或管道接頭部分將因冷卻而引起水份凝露。 • 這是因為在制熱運轉時或除霜運轉時，會流出溶化的水或水蒸氣的緣故。 • 因為制熱運轉中會滴下附着在熱交換器上的水滴。
室外機組放出白烟。	<ul style="list-style-type: none"> • 制熱運轉中，解凍操作產生蒸氣看似白烟。
剛開始制熱運轉中時，不會馬上就吹風。	<ul style="list-style-type: none"> • 正在準備能吹出足夠溫暖的風。就這樣請等候。
制熱運轉中停止運轉大約10分鐘。	<ul style="list-style-type: none"> • 正在溶化室外機組上的結霜。(除霜運轉)最長10分鐘就完了，就這樣請等候。(戶外氣溫低而濕度又高時，便會結霜。)
左右和上下導風板暫停擺動送風又重新開動。	<ul style="list-style-type: none"> • 這是為了正常執行左右和上下導風板的擺動送風。
有時聽到“嘶嘶”聲。	<ul style="list-style-type: none"> • 這是空調機內部制冷劑切換流向發出的聲音。
房間不能充分制冷和制熱。	<ul style="list-style-type: none"> • 排風扇或液化電具使用時，制冷負荷加重，導致制冷效果不足。 • 室外氣溫太高或太低時，制冷或者暖效果不足。

移機 · 檢查

檢查維修

- 空調機用過幾年之后因內部骯髒，性能將減低。
- 因使用狀況而可能發生臭味，或因堆積塵垢而造成冷凝水的排水不良。
- 與普通的檢查維修不同，最好請專門技術人員為您服務。請與本空調機的出售店或技術服務中心聯系。

運轉噪聲問題也須考慮內

- 室外機組的排風口附近不可堆置東西。因為將會減低機器效能也可能增大運轉噪聲。
- 運轉作用中，如果發生異常聲，即請與本空調機的出售店或技術服務中心聯系。

要移機時

- 因增改建房間，遷居而須拆卸下空調機及再安裝時，必須找專門技術人員為您服務。

⚠ 警告：
用戶請不要自己修理或移設空調機。如果處理不當，便有發生火災、觸電、機組掉落傷人、漏水等危險。如制冷劑中有空氣等物質混入，會導致壓力升高，發生破裂等。因此請于本空調機的出售店或技術中心聯系。

安裝安全事項

1. 為確保安全，請注意下列各項

⚠ 警告

用戶不可自行安裝。

- 如果安裝不妥，可能引起火災、觸電、零件掉下傷人或漏水等。請與銷售店或技術服務中心聯系。

機器必須安裝在能承受相當重量的地方。

- 如果安裝在強度不夠的地方，將有機組掉下傷人的危險。

室內外機組之間的配綫，須使用規定的電綫連接妥當，并使接綫端子不直接受到外力的影響確實固定好。

- 連接或固定不好，可能引起火災事故。

安裝工作必須根據安裝說明書準確地實施。

- 如果安裝得不妥，可能引起火災、觸電、零件掉下傷人或漏水事故。

安裝施工中如發生制冷劑泄漏，請進行換氣。

- 制冷劑與明火接觸會產生有毒氣體。

⚠ 警告

安裝或移機時制冷劑回路中不能混入除制冷劑以外的其他物質。

- 如果空氣等物質混入會導致系統壓力升高、發生破裂等。

回收制冷劑時，在拆下連接管前關閉壓縮機。

- 如果當壓縮機運轉并截止閥開啓時，拆下連接管會有空氣混入，會造成系統壓力異常升高，造成管子爆裂或引起傷害。

裝機時，在啓動壓縮機前確保管子安全的連接。

- 如果在管子連接完成前，并在截止閥開啓時運行壓縮機，會有空氣混入，會造成系統壓力異常升高，造成管子爆裂或引起傷害。

電氣施工應按照安裝說明書實施，請一定要使用專用電路電源。

- 電源電路如果容量不夠或施工不完全、可能發生火災或有觸電的危險。

室內機組的電氣蓋和室外機組的維修板須確實安裝好。

- 室內機組電氣蓋和室外機組的維修板如果不裝好，則可能因為灰塵、水份進入而造成火災或觸電危險。

安裝安全事項

⚠ 警告

安裝施工用部件，必須使用附帶的和規定的部件。

- 采用部件不當，可能引起火災、觸電、或機組掉下傷人、漏水等事故。

電源線路的中途引綫，使用延長電源綫，或使用多孔插座綫等都不可采用。

- 接觸不良，絕緣不良，或超載等都可能引起觸電事故。

須做接地施工。

- 空調插座應連有專門接地綫，如果没有接地綫或地綫沒有連接好，可能引起觸電事故。
- 地綫切勿接到煤氣管、自來水管、避雷針導綫，電話接地綫上。

禁止安裝在有可燃性氣體泄漏的地方。

- 萬一可燃性氣體泄漏而聚集在機組周圍，可能引起爆炸事故。

應裝有漏電保護器。

- 如不裝上漏電保護器，可能引起觸電事故。

請一定按照安裝說明書進行排水和配管施工。

- 排水和配管施工如果有不妥當的地方或室內機組傾斜將可能產生機組滴水弄濕、污損家具物品等情況。

連接導綫的中途引綫是一定不可采用的。

- 一定會產生機組誤動作，造成機組無法正常運行。

請遵照國家的接綫規則安裝本機組。

安裝施工完畢后，須確認是否有泄漏制冷劑氣體的地方。

如果電源軟綫損壞，必須使用專用軟綫或從制造廠或維修部門買到的專用組件來更換。

此外，如果還有不明白的地方，即請找機器的出售店聯系。

2. R410A制冷系統注意事項

2-1 適用R410A制冷劑的空調器

⚠ 警告

- 使用C1220銅磷料(用于銅和銅合金制成的無縫管)連接制冷劑管。確保管內壁清潔，不含有硫化物、氧化劑、碎屑或灰塵等任何有害的臟物。務必使用指定厚度的管道。
- 使用脂油、乙醚油、烷基苯油(少量)作為制冷劑油，塗在喇叭口的部分。如果把礦物油混入制冷劑油中，油質可能變差。
- 切勿使用R410A以外的制冷劑。如果使用其它制冷劑，氣會使油變質。
- 使用以下專門為R410A制冷劑設計的工具。使用R410A制冷劑時必須使用以下工具。請諮詢就近的經銷商。

工具(用于R410A)	
壓力表	擴口工具
加液軟管	尺寸測量器
檢漏儀	真空泵轉接頭
扭矩扳手	電子秤

- 務必使用正確的工具。如果灰塵、碎屑或水氣進入制冷劑管，制冷劑油的油質可能變差。
- 切勿使用簡易加液鋼瓶。如果使用簡易加液鋼瓶添加制冷劑，制冷劑的成分會改變，引起效率降低。

2-2 使用R410A制冷劑設備的注意事項

⚠ 警告

- 安裝或移動空調器時，務必使用指定的制冷劑(R410A)充注制冷劑管。切勿與其他制冷劑混合，管內也不要殘留空氣。殘留在管內的空氣在壓力增大時，會使管道爆裂，并引起其他危險。

MSZ-YE18VA-H1	
液體管	Φ6.35厚0.8毫米
氣體管	Φ12.7厚0.8毫米

- 切勿使用管壁比上述指定厚度薄的管道。真空泵切勿與R22制冷劑系統共用。

安裝安全事項

3. 選擇安裝位置

3-1 室內機組

- 選擇在進出氣流不被擋住的地方。
- 選擇吹出冷氣可以到達房間各地方。
- 室內機組與室外機組最大距離及最大高度差: 參考“極限管道長度”。
- 不至于發生振動的堅固牆壁上。
- 避免陽光直射的地方。
- 容易排水的地方。
- 距離電視機、收音機1m、電視天線3m以上的地方(否則可能干擾電視影像或產生噪聲)。
- 盡可能遠離日光燈、白熾燈處(否則可能使無線遙控不能正常地操作)。
- 可自由、方便地進行裝、卸空氣過濾網的地方。

3-2 室外機組

- 選擇受大風和大雪影響小的地方, 如在嚴重降雪的區域內安裝, 請必須進行防雪處理(建議安裝遮蓋篷和/或底座機架)。
- 選擇通風良好, 灰塵少的地方。
- 不容易雨淋或陽光直曬的地方。
- 不要使運行噪音或吹出熱風有妨礙鄰居的地方。
- 為了不使運行噪音或振動增大, 應牢靠地安裝在牢固的機架上。
- 應避開有易燃氣體洩漏危險的地方。
- 當機組安裝在高處時, 務必固定機腳。
- 務必水平安裝。
- 便于保養維修。

電視機或收音機等無線接受設備需距離室外機3m以上, 如這樣還有明顯信號干擾時, 可再加長相互間距離, 以提高接受質量。

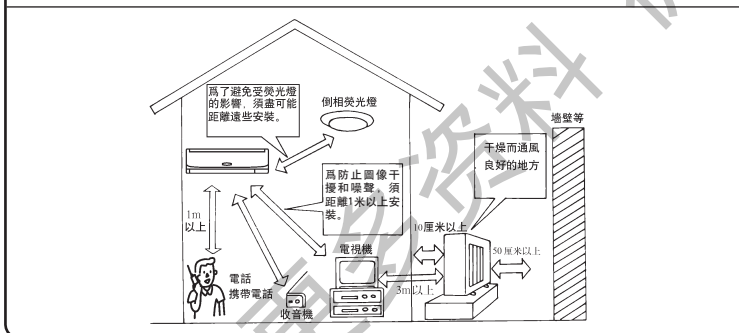

⚠ 注意

請不要在下述容易發生故障的地方安裝空調器。

- 機油等使用較多的地方。
- 海邊等鹽份較多的地方。
- 溫泉地帶。有硫化氣體的地方。
- 其他環境大氣有問題的地方。
- 避免安裝在有揮發性、腐蝕性、可燃性化學品的地方。
- 吊車、船舶等移動的地方。

安裝說明

1. 安裝簡圖及附件

裝箱單 (在安裝之前, 請客戶根據裝箱單內容核對零件數量)

零件名稱		數量	零件名稱		數量
安裝代號			安裝代號		
室內	室內機	1	室外	室外機	1
	① 安裝板	1		① 連接電綫	1
	② 螺釘4×25毫米	5		② ※ 連接配管	1
	③ 電池(7號)	2		③ ※ 穿牆套筒	1
	④ 遙控器	1		④ ※ 牆孔蓋	1
內	⑤ 毛氈包扎帶	1	⑤ ※ 管道包扎帶	1	
	保用證書	1	⑥ ※ 延長排水軟管	1	
機	使用安裝說明書	1	⑦ 排水塞	1	
			⑧ ※ 膩子	1	

※ 此部品現地購置。

擴口連接

- 本機組在室內和室外側備有擴口連接部位。
- 如下圖所示, 制冷劑管道用于連接室內和室外機組。

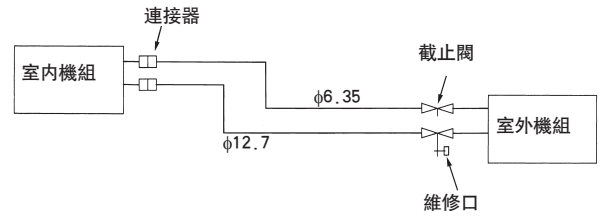

極 限	
管道長度	12米
高度差	8米
彎管數量	10處

- 制冷劑調節...如果管道長度超出下表範圍時, 則需要補注制冷劑(R410A)。(加注有制冷劑的室外機組適用於以下管道長度以內。)

管道長度	機型	需要添加制冷劑的量
超過6米	MSZ型(變頻)	30克×(冷氣管長度(米)-6)

- 說明: 延長配管過長會導致制冷/制熱能力下降。

△ 注意

(1) 在寒冷的地區不要使用此排水管接頭及橡膠塞, 可能會因排水凍結而發生故障。

排水管安裝步驟

- (1) 在底座上選擇一個排水孔作為排水用, 將排水管接頭裝在該孔上。
- (2) 用橡膠塞將底座上剩余的排水孔封掉。
- (3) 將排水管與排水管接頭連接, 為使排水順暢, 請保持排水管向下傾斜。

圖示說明:

- 牆孔蓋 (Wall Cap)
- 須注意, 切勿讓排水軟管抬高。 (Note: Do not raise the drain pipe.)
- 管道的配管可以往背後, 右側, 下側, 左側, 左後方方向引出配置 (The pipe can be routed to the back, right, bottom, left, or left-back direction).
- 分開兩連接管道, 分別包扎隔熱材料。 (Separate the two connection pipes and wrap them with insulation material separately.)
- 在使用薄銅板 (鍍鋅薄板) 或者金屬網的牆壁上安裝管道時, 應採用厚度20毫米以上的木板夾在牆壁和管道之間, 或者在管道周圍包扎絕緣塑料帶7至8層。 (When installing pipes on walls made of thin copper plate (galvanized thin plate) or metal mesh, use a wooden board with a thickness of more than 20 mm between the wall and the pipe, or wrap the pipe with insulation plastic tape 7 to 8 layers.)

機組必須按照當地規定由持有執照的承包商安裝。

安裝說明

警告

- 室內外機組之間的配綫，須使用規定的電綫連接妥當并使接綫端子不直接受到外力的影響確實固定好。
- 如果連接或固定不妥，可能引起火災事故。
- 電綫固定夾電氣蓋必須確定固定好，如沒有裝好，則可能因為灰塵、水份進入而引起火災或觸電事故。
- 注意不能連錯綫。
- 如果地綫連接錯誤，有可能導致觸電。

注意

- 旋緊端子螺釘以防松脫。
- 旋緊螺釘后，輕輕拉動電綫確認是否能拉動。
- 如果接綫不正確連接到端子盒，空調機就不會正常運轉。

警告

- 室內外接綫端子臺之間的連接電綫必須按標注號碼一一對應連接。

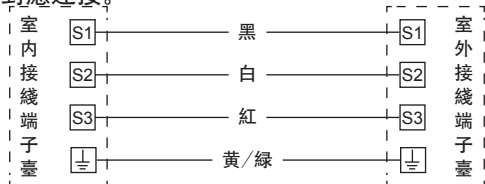

MSZ 型 變頻型

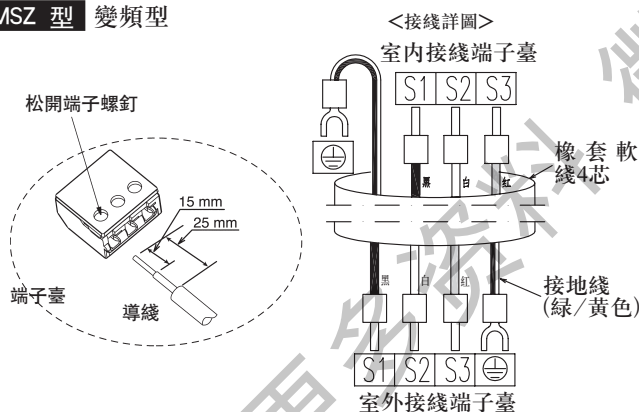

警告

- 家中電源插座內火綫、零綫、接地綫必須按如圖連接，位置不能接錯，并連接可靠，無內部短路。
- 連接錯誤，有可能導致火災。

電源檢查 用戶家中供電插座示意圖

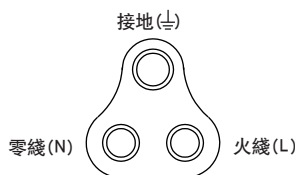

2-5 自動重新啓動功能

使用遙控器控制空調機時，室內電控基板會記憶運轉模式、設定溫度以及風扇速度，如果運轉時發生斷電，自動重新啓動功能就會在恢復供電后工作，使空調機自動重新啓動，如果空調機在斷電前是以“**I FEEL CONTROL(體感控制)**”模式運轉，此模式就會被記憶。在“**I FEEL CONTROL(體感控制)**”模式下，空調機的運轉由(重新)啓動時的室內溫度決定。

如何設定“自動重新啓動功能”

- 卸下前面板。
- 卸下電氣蓋的螺釘。拆下電氣蓋。
- 從CN151拔下葉片電動機接頭，拆下電氣盒內的風葉電動機導綫。
從CN111, CN112拔下溫度傳感器接頭。
從CN110拔下動態地面溫度傳感器接頭。
- 拉出電控基板，切斷其上的電阻JR07。

運轉

- 如果切斷了主電源，運轉設置仍被保留。
- 恢復供電3分鐘后，空調機會根據存儲器記憶的內容自動重新啓動。

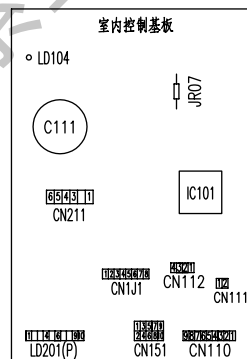

注：

- 操作遙控器10秒鐘之后，運轉設置就會被保存。
- 當啓動了自動開機/關機定時器時，如果關閉了主電源或是發生斷電，定時器設置就會被取消。由于這些型號都具備自動重新啓動功能，一旦恢復供電，3分鐘后空調機就會開始運轉。
- 如果在斷電前用遙控器關閉了空調機，由于遙控器上的電源鍵關閉，自動重新啓動功能就會不起作用。
- 爲了防止起動電流對電源的衝擊，請有序安排其他家用電器開機時間，避免同時開機。

2-6 配管作業

- 一定要將排水軟管配置在制冷劑管道的下方。
- 不要使排水管隆起或盤曲。
- 不要拉着排水軟管進行包扎。
- 排水軟管須通過室內時，一定請用市售的隔熱材料纏繞包扎。
- 用毛氈膠帶⑤包裹配管、排水軟管，并收納在室內機組后面的配管收納部裏面。

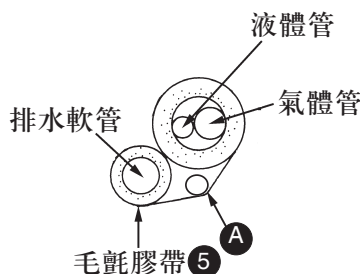

安裝說明

向后、向右和向下鋪設管道

管道鋪設

- 管道配置
將制冷劑管道和排水軟管匯總在一起，使用包扎帶進行纏繞。

注意，切勿使排水軟管抬高起來。
由管道末端開始，使用管道包扎帶⑤牢靠地纏繞。

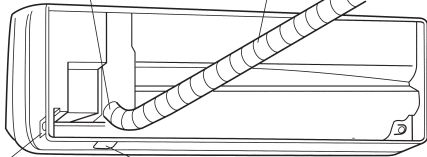

往右側配管時切掉此部分。 往下側配管時切掉此部分。

- 把管道和排水管插入牆壁孔套管②，并把室內機組的上半部分挂在安裝板①上。
- 左右移動空調機，檢查空調機是否可靠地挂在安裝板①上。

向左或者左后鋪設管道

- 管道配置
將制冷劑管道和排水軟管匯總在一起，先用管道包扎帶進行纏繞，再用毛氈包扎帶⑥進行纏繞。

注意，切勿使排水軟管抬高起來。
往左側方向配管時，在此切斷去掉。

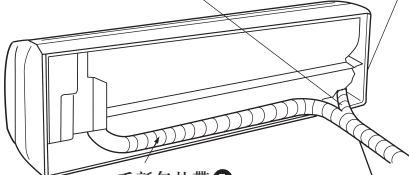

應從管道末端開始纏繞毛氈包扎帶⑥(毛氈包扎帶⑥重疊部分應為毛氈包扎帶寬度的1/3)
應在毛氈包扎帶⑥最終端上，使用膠帶固定。

排水軟管的改裝法

左、左背后配管時，一定也要把排水管改裝過，如果不加改裝，可能產生滴露水。

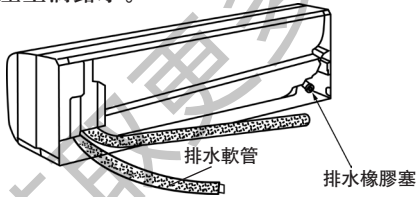

1 室內機組背面右側的橡膠塞

抓住尖端凸緣部分把橡膠塞拔下來。

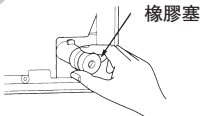

2 卸下室內機組背面左側的排水軟管

抓住箭頭所指握手部分按⇨方向拔出排水軟管。



3 將橡膠塞塞入室內機組背面裝插排水管的部位

用內六角扳手把橡膠塞壓入排水盤接口處。



4 將排水軟管接插到室內機組背面右側的排水軟管接插部位

請將排水軟管插到排水盤接口處。一定要確認軟管是否確實卡住排水盤的突起卡爪。

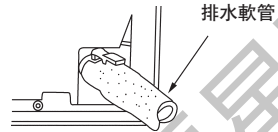

制冷劑管與延長配管的連接

如果在牆中已埋設有延長配管或配線時，即請按照下圖所示要領進行配管連接工作。

- ① 將室內機組上部鉤住安裝板①，并考慮到配管的收納而盡可能向左邊靠緊之后，切下一塊包裝材料(當襯墊用)使卡住背面凸緣，如右圖所示抬高室內機組。
- 把制冷劑管與延長管②連接起來。
切下包裝材料的一部分(襯墊用)卡住背面凸緣

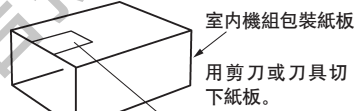

使用遮蔽膠帶或室內機組下側所附膠帶固定末端。

如上圖所示卷起切下部分。

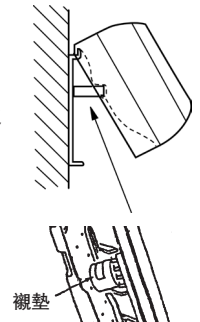

如上圖所示，一邊注意方向，一邊將襯墊確實地套進背面凸緣的凹陷部分。

室內機組的安裝

- 將管道穿過牆壁，將機組吊裝在安裝板①上，推入室內機組直到它發出咔嗒一聲。

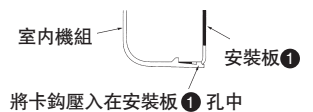

2-7 排水管道鋪設

為了使排水順暢，應使排水管道形成往下傾斜狀態配管。(圖1)

切勿使排水管道連接形成如圖2~圖3上所示。

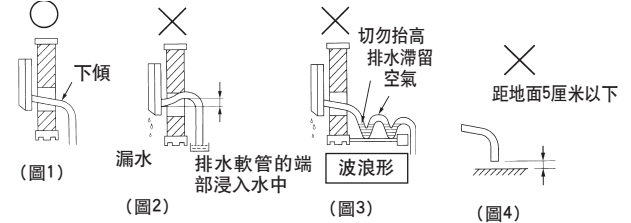

假如裝在室內機組上的排水軟管，使用時長度還不够，可採用附件中的排水軟管③連接使用。
排水軟管需通過室內時，一定要使用市場上銷售的隔熱材料纏繞包扎。

安裝說明

3. 室外機組的安裝

室內/室外連接

- 將來自室內機組的電線，正確地連接在接線端子臺上。
- 注意禁止使連接導線接觸配管。

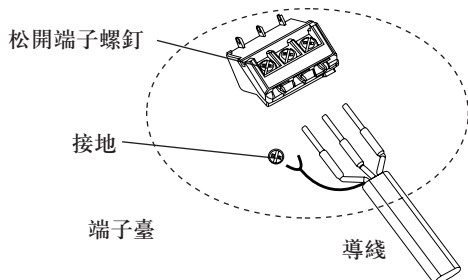

⚠ 注意

- 注意不能連錯綫。如果接綫不正確，空調機就不會正常運轉。
- 旋緊端子螺釘以防松脫。
- 旋緊螺釘后，輕輕拉動電綫確認是否能拉動。

一定請用此導綫夾將室內/外連接電綫 A 固定好。

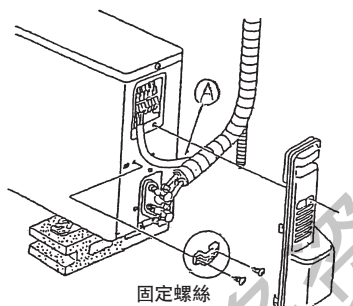

⚠ 注意

確實固定好室外機組的維修板。維修板如果沒固定好，將因為灰塵、水份等進入而引起火災、觸電事故。

⚠ 注意

- 空調器的安裝面應堅固結實，具有足夠的承載能力，其承載能力不低於實際所承載的重量(至少200kg/m²)
- 安裝面為木質、金屬或非金屬等結構，如果其強度明顯不足時，應採用相應的加固、支撐和減震等措施。
- 安裝架必須使用能使空調器可靠地固定在安裝面上的緊固件。
- 安裝時使用的緊固體，應根據安裝面材質堅硬程度確定安裝孔直徑和深度，並選擇適用的膨脹螺栓規格，確保安裝空調器穩定、牢固、可靠。
- 安裝時避開雨天、風雪天、雷雨天進行安裝，必要時採取相應措施保證自身和他人不受傷害。

4. 完成室內/室外機組連接以及進行試行運轉

4-1 管道連接

① 室內機組接管

連接液，氣配管至室內機組。

- 首先對准中心，然后用手旋上管螺母至無法轉動。
- 參考下面扭矩表，使用兩只扳手擰緊室內機組側接管接頭部分。請注意勿過度扭緊，以免損壞擴口部分。

管徑		旋緊扭矩	
毫米	英寸	牛頓·米(N·m)	公斤力·厘米(kgf·cm)
6.35	1/4	13.7到17.7	140到180
12.7	1/2	49.0到56.4	500到575

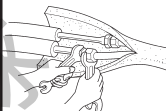

② 室外機組接管

與室內機組相同方法把配管接到室外機組的截止閥(2通和3通閥)管接頭。

- 使用扭矩扳手或普通扳手，用和室內機組同樣的扭矩旋緊。

⚠ 警告

- 裝機時，在啓動壓縮機前，確保管子安全的連接。

隔熱及纏繞包扎帶

① 室外機組側的各配管及閥都須作隔熱處理。

② 從室外機組的配管入口起的全部配管都須用管道包扎帶

纏繞包裹。

- 用膠帶固定管道包扎帶的末端。
- 如果配管通過天花板，盥洗間或其他高溫高濕的地方時，請加包裹以市售隔熱絕緣材料，以防凝露。

4-2 抽真空·洩漏試驗

抽真空過程

- 連接室內機組與室外機組之間制冷劑管道(液體及氣體管道)。
- 卸下室外機組氣體管道側的截止閥的維修口蓋(不卸下蓋子無法進行抽真空過程。)
- 利用真空泵
- 將量規歧管閥和真空泵連接到室外機組氣體管道側上面的截止閥的維修口上。
- 轉動真空泵(抽真空達15分鐘以上)。
- 用量規歧管閥檢查真空，然后關閉量規歧管閥，並停掉真空泵。

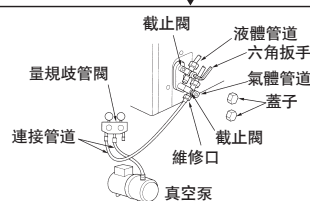

迅速地從截止閥的維修口卸下量規歧管閥

全開氣體和液體管道側的所有截止閥，若不全開截止閥運轉，將降低機器性能或引起故障等。

管道長度在限定範圍內，無須補充制冷劑。

管道長度超過一定範圍，補充定量制冷劑。

旋緊維修口蓋

再旋緊兩個截止閥蓋

洩漏試驗

安裝說明

	緊固力矩	
	牛頓·米	公斤力·厘米
維修蓋	13.7到17.7	140到180
截止閥蓋	19.6到29.4	200到300

4-3 試運行運轉

MSZ 型 變頻型

- 在進行運行之前，應再次檢查是否有錯誤的接線。錯誤的接線會妨礙正常的操作，或熔斷保險絲而不能起作用。
- 可用應急開關開始試運轉。按下應急開關，機器即根據所選模式開始連續制冷或制熱運轉30分鐘。在此30分鐘內，恆溫器不起作用。30分鐘後，機器將開始以24℃的固定設定溫度進行制冷模式或制熱模式的應急運轉。
- 按下列程序進行試運行。

程序

- 按下應急開關。
 - 按一次開關即試運行30分鐘後應急制冷模式啓動。
 - 再按一次即開始應急制熱運轉。
 - 再按一次即停止運轉。
 每次按下應急開關即將作①→②→③的反覆。

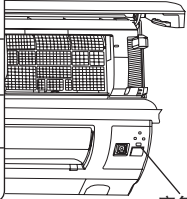
模式	測溫	指示	應急運轉開關
① 制冷	測溫	☀ L R □ (亮) (滅)	
② 制熱	測溫	□ L R ☀ (滅) (亮)	
③ 停止	測溫	□ L R □ (滅) (滅)	

注意：

- 這是應急運轉模式的指示，在應急運轉期間測溫方向的設置無效。

確認接收到遙控器的信號

按了遙控器的運轉/停止按鈕後，請確認室內機組的本機上是否發出嗶!聲。然後再按一次按鈕以關掉機器。

用遙控器控制時，遙控器指令運轉後，應急運轉都將被解除。

- 爲了保護壓縮機，空調器停止後3分鐘內即使重新開機，室外機也不會被啓動。

4-4 應對用戶說明的事項

- 請按照使用說明書，向客戶介紹有關溫度調節控制的方法、空氣過濾網的拆卸、左右導風板組件的拆卸方法、清掃方法、及在操作使用時的注意事項等。

5. 安裝後的遷移安裝和維修

5-1 如何安裝前框

- 在安裝前框以前，請將上下導風板設定於3號(第11頁)位置。
- 在上下導風板下方插入前框底邊。
- 固定好前框頂部。
- 按下前框上搭扣，將前框固定於空調器上。

5-2 卸下室內機組

從安裝板上拉出室內機組的底部

松脫兩角

按下圖所示，把室內機組的左右下角往下和往前拉，鬆開鎖鈎。

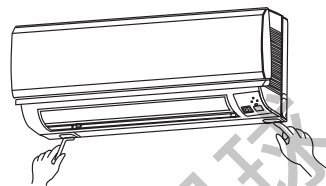

如果不能採用上述方法時

如果不能採用上述的方法，即請卸下前框並如下圖所示將六角扳手插入左和右邊方孔中，然後將六角扳手往上推。室內機組底部被壓下，掛鈎即被釋放。

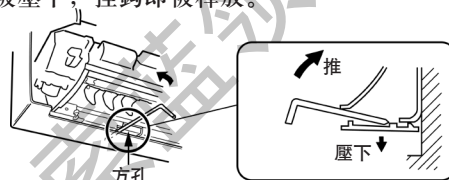

5-3 補充制冷劑

- 將儲氣瓶接在截止閥(3路)的維修口。
- 用來自儲氣瓶的制冷劑進行管道(或軟管)的氣洗。
- 在空調機以制冷狀態運行時，補充指定量的制冷劑。

⚠ 注意事項

- 補充時，請勿倒轉儲氣瓶灌制冷劑，否則，可能發生問題。

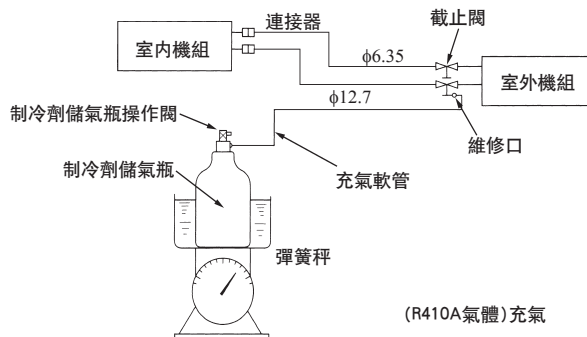

爲使儲氣瓶保持高壓，在寒冷季節時，請用溫水(40℃)加熱。但禁止使用火烤或用熱蒸氣蒸熱。

注：①室內接線圖貼在室內機組前框內側。

②室外接線圖貼在室外機組電控盒。

5-4 如何回收制冷劑

- 務必使用壓力表。
- 首先進行冷房運轉。
- 再完全關閉高壓側的閥門(液閥)，壓力表讀數必須在0~0.05MPa時(約30~40秒後)，完全關閉低壓側閥門(氣閥)，立即停止運轉。
- 在確保關閉液閥/氣閥閥門後並切斷電源，才能拆卸連接管道。

⚠ 警告

- 在回收制冷劑時，拆下連接管前關閉壓縮機。如果空氣等混入，會造成壓縮機爆裂。

技術規格

型 號	MSZ-YE18VA-H1
防觸電保護	I類
電源	220V~50Hz
制冷量(W)	5000(1250~5200)
制熱量(W)	6100(1100~8100)
制冷輸入功率(W)	1920(240~2170)
制熱輸入功率(W)	2080(200~3150)
制冷輸入電流(A)	9.4
制熱輸入電流(A)	9.7
中間制冷量(W)	2400
中間制熱量(W)	3000
中間制冷輸入功率(W)	540
中間制熱輸入功率(W)	650
低溫制熱量(W)	5850
低溫制熱輸入功率(W)	2690
循環風量(制冷時/制熱時)(m ³ /h)	612/640
加液量(g)	1500
室內噪音 制冷時(dB(A))(高速檔/低速檔)	43/32
室內噪音 制熱時(dB(A))(高速檔/低速檔)	40/31
室外噪音 (dB(A)) 制冷/制熱	50/51
室內淨質量(kg)	10
室外淨質量(kg)	36
室內尺寸高×長×寬(mm)	295×834×252
室外尺寸高×長×寬(mm)	550×800*×285
排氣側最高工作壓力	4.15MPa
吸氣側最高工作壓力	1.64MPa
熱交換器的最大工作壓力	4.71MPa
儲罐允許工作過壓	1.94MPa

* 含維修板長度為869。

注：①本產品適用環境溫度範圍：

		室內	室外
制冷	上限	32℃干球 23℃濕球	43℃干球 —
	下限	21℃干球 15℃濕球	21℃干球 —

		室內	室外
制熱	上限	27℃干球 —	24℃干球 18℃濕球
	下限	20℃干球 —	-8.5℃干球 -9.5℃濕球







② 噪音值是表示出廠前全消音試驗室環境下測得數據。

③ 產品執行：GB/T7725 IEC 60335-1 IEC 60335-2-40 IEC 62233









Safety precautions

- Please read this [safety precautions] before use.
- The precautions mentioned here are about very important contents for safety, which should be followed.





Symbols used in text

-  :Forbidden.
-  :Be sure to do following instructions.
-  :Inserting fingers or sticks is not allowed.
-  :Stepping or piling on the indoor/outdoor unit is not allowed.
-  :Risk of electric shock, take care.
-  :Be sure to remove the power plug.
-  :Be sure to turn off the power supply.
-  :Must be grounded.

- Please keep the manual in a place which is accessible for reference after reading.
- Young children or weak people must be supervised to use the air conditioner.





 Warning	
	Don't connect wires in the middle section of a power cord or extend the cord and use multi-cable socket. • Fire or electric shock may result from poor contact, poor insulation and overcurrent.
	Don't damage the power cord or use it for connecting or processing. • Piling on the power cord and damaging or heating/connecting/processing the power cord may damage the cord to cause fire or electric shock..
	Don't remove the power plug in operation. • Sparkle may occur to cause fire. • After turning off the indoor unit by a remote controller, be sure to switch off the protection switch or securely remove the power plug.
	Don't let the cold airflow blow the skin directly for a long time. • May do harm to health.
	Don't install the machine by yourself. • Improper installation may cause fire, electric shock, water leakage or injury from machine falling. Please contact the specialty shop or technical service center for help.
	Don't use the air conditioner in an environment to place or use volatile, corrosive and combustible chemicals. • Don't use the air conditioner when volatile, corrosive and combustible chemical products(such as xylene, isoamyl acetate and methanol) are used in room. • Doors and windows should be opened for ventilation if the paint in decorated room is not dried. The air conditioner can't be used until the gas from thinner evacuates. Otherwise, corrosion, deformation and even fire may result.
	Don't put a combustion apparatus in a place directly facing the airflow outlet. • Incomplete combustion for combustion apparatus may result.
	Don't spray directly with pesticide, disinfectant and combustible spraying material. • Fire and distortion may result.
	If the installation stand is antiquated, don't ignore it. • The unit may tumble and cause injury.
	Standing on an unstable footstool is not allowed in case of unit maintenance. • Fall and injury may result.
Don't pull the power cord. • Hold the plug and pull it out while removing the power cord. Otherwise, fire may result from partial disconnection of the power cord pulled.	
 	Inserting fingers or sticks in the inlet and outlet is not allowed. The installation height of indoor unit must assure that the wind leaf be 2.3 meter above the ground. • Injury may result from inside high-speed fan. • Young children must be supervised to ensure that they don't play with the air conditioner.
 	In case of abnormality(a burnt taste), stop operation at once, pull out the plug and switch off power supply. • Keeping on operation in case of abnormality may lead to fire and failure. Please contact the specialty shop or technical service center for help.
	Remove the dust on the power plug and make a stable insertion. • Fire or electric shock may result from the plug with dust or poor insertion. When using the air conditioner together with a combustion apparatus, you shall ventilate the room frequently. • Insufficient oxygen may result. Remove the power plug in case of long term out-of-service. • Fire and accident may result from dust pileup.
	Stepping or piling on the indoor/outdoor unit is not allowed. • May fall down to be injured or get injured due to unit fall.
	Don't try to repair the unit by yourself or remove the unit. • Maloperation may cause fire, electric shock, water leakage or injury from unit fall. Please contact the specialty shop or technical service center for help. • If a power cord is damaged, the manufacturer or service provider shall replace it to avoid loss.

Safety precautions

 Note	
	When removing the filter, you shall take care not to touch the metallic part of the indoor unit. • Probability of being scratched.
	Don't put animals and plants in a place directly facing the airflow outlet of the air conditioner. • May have bad impact on the animals and plants.
	Don't charge or remove the battery, and don't put it in fire. • May cause battery leakage, fire or explosion.
	Don't open doors and windows and let the air conditioner operate in high humidity for long period. • In cooling mode, if the air conditioner operate in high humidity(over 80%) for long period, condensed water may drop from the unit, wet and contaminate furniture.
	Don't use the air conditioner for other applications. • The air conditioner is not used to preserve precise apparatus, food, animals and plants and artwork due to probability of lowering their quality.
	When cleaning the air conditioner, you shall stop operation and remove the plug or turn off the power supply. • High-speed revolving fan may cause injury in operation.
	Change two new batteries of the same type. • Combination of new and old batteries can cause heating, leakage or explosion.
	If the battery fluid splashes against the skin or clothes, please clean them carefully with clear water. • If the battery fluid splashes into the eyes, wash the them immediately and see a doctor.
	Don't operate a switch by a wet hand. • Risk of electric shock.
	Don't wash the air conditioner with water. • If there is water inside the unit, the insulation feature will be lowered and electric shock may result.

Installation of air conditioner

 Warning	
• At the time of installing a machine, please contact the specialty shop or technical service center for help.	

 Note	
	Don't install the unit in a place where corrosive and combustible gases may leak. • There is a risk of explosion or machine damage in case of gas leakage or gas deposit around the unit.
	Don't pile up other electric appliances or furniture under the indoor/outdoor unit. • Contamination or device failure may result from drips from the unit.
	Must be grounded. • The socket for air conditioner should be connected with special earth wire. The earth wire shall not be connected to gas pipe, tap water pipe, lightning rod or telephone earth wire. Electric shock may result in case of no earth wire or poor grounding. Thus, before using the unit, you have to confirm whether there is an earth wire or grounding connection as required.
	Earth leakage circuit breakers must be installed in some installation fields (such as place with high humidity). • If an earth leakage circuit breaker is not installed, an electric shock may result.
	Make sure to have a smooth draining at the draining port. • If the draining is in poor condition, the unit may wet and contaminate the furniture.

Part name

Indoor unit

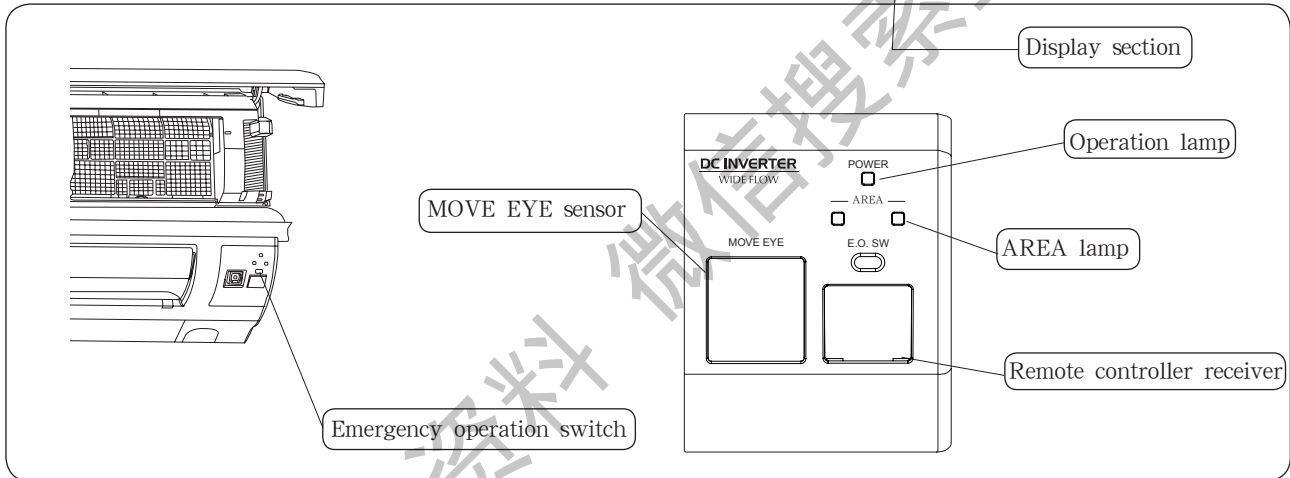
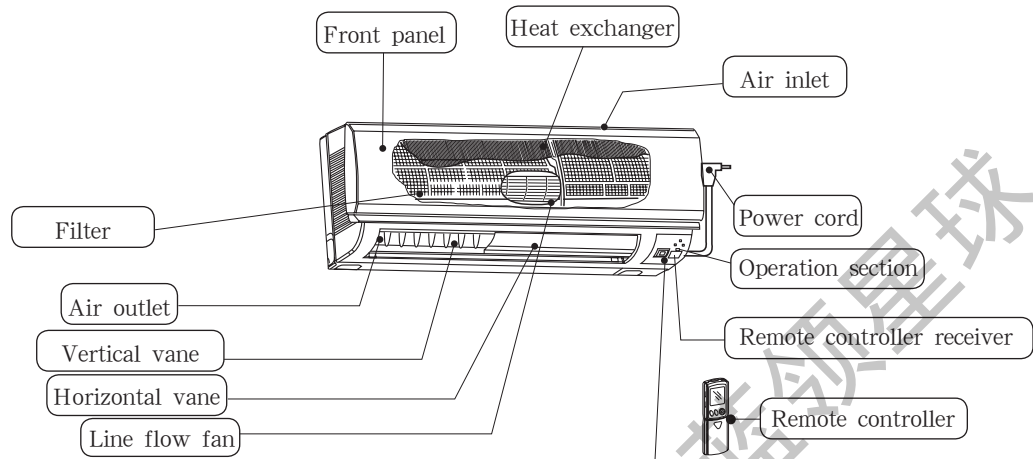

Outdoor unit

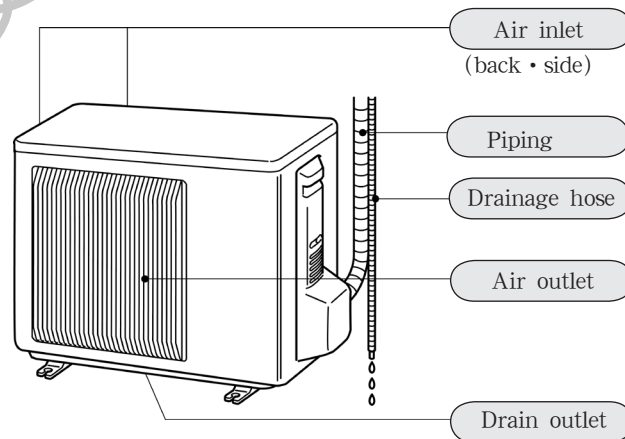

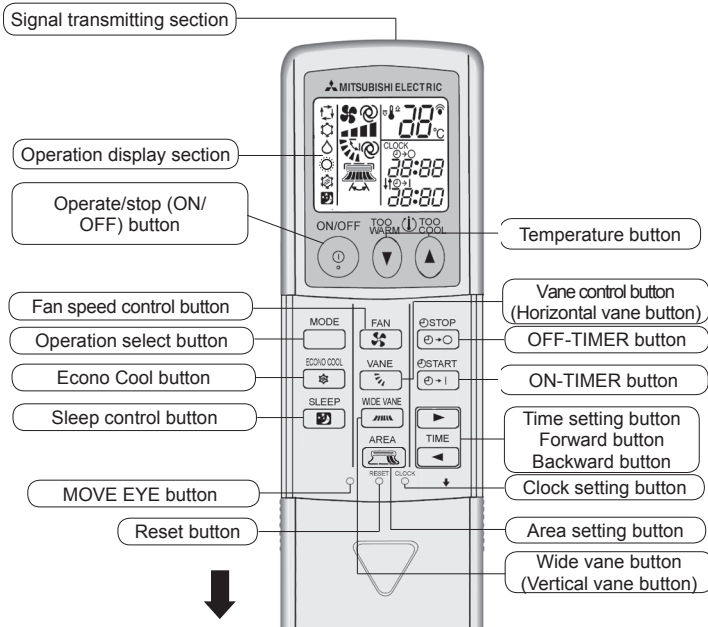

Preparation before operation

Remote controller

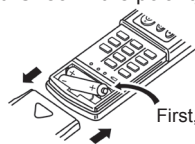

Important setting

How to install battery and set current time





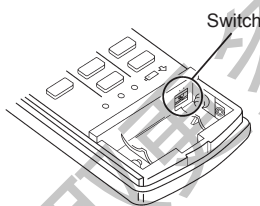

- 1 Remove the frontal cover and install batteries. Then, reinstall the cover. Insert the cathode of the batteries in the first. Check if the polarity is correct.
 
- 2 Press the reset button. Use sharp thing to press it.
 - If the reset button is not pressed, the remote controller can't work normally.
 - Note that the pressing shall not be done forcibly.
- 3 Press the Clock setting button. Use something sharp at the end to press it.
- 4 Press  (forward) and  (backward) button (time setting button), set current time.
 - Each press of the Forward button increases one minute;
 - Each press of the Backward button decreases one minute.
 - If you press and hold down the button for a long time, the set time will increase/decrease in ten minutes intervals.
- 5 Repress the Clock setting button and close the frontal cover.

HOW TO SWITCH OVER <REMOTE CONTROLLER>

The details of SLIDE SWITCH

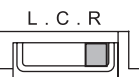
- ① Remove the front lid.
- ② Be sure to set the slide switch inside the remote controller to an appropriate position in accordance with the installed position of the indoor unit. If the switch is not set correctly, the air conditioner may not function properly.



Area	Left	Center	Right
Position of the slide switch			
Display on the remote controller			

Where is the indoor unit installed in the room?

Installed at left, if the distance is not more than 50cm.

Installed at right, if the distance is not more than 50cm.

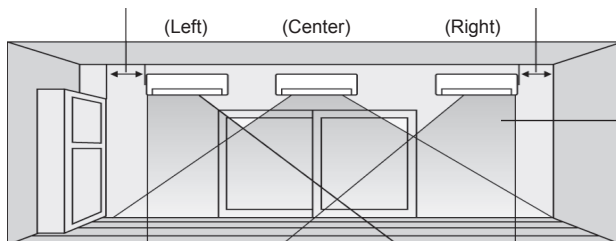

Is the indoor unit installed at right, left or center?

* If the indoor unit is installed more than 50 cm away from the side walls, cabinets or other nearby objects, set the slide switch to the "center" position.

Preparation before operation

How to use the remote controller

- The signal can travel up to 6 meters (in a straight line) away from the frontal face of indoor unit.
- At the time of pressing the button, the indoor unit beeps once or twice to confirm the signal received. If the unit doesn't beep, press the button again.
- Use the remote controller carefully.
If it falls down to the ground, is thrown or soaked in water, malfunction may result.

Battery

Standard for replacing battery

- Two new alkaline batteries (No.7, LR03) shall be replaced in the following condition:
- The indoor unit has no response to the signal sent from the remote controller.
- The display of the remote controller becomes light. Please don't use manganese battery, or the remote controller will be in failure.
- The lifespan of a alkaline battery is about one year. However, it's recommended to consider the expiration date (year/month) at the bottom of a battery. If the expiration date draws near, the battery should be replaced as soon as possible.
- In order to avoid fluid leakage, please take out the battery if it is not used for a long time.

Note:

- If the battery fluid splashes against skin or clothes, please wash them with clear water carefully.
- If the battery fluid splashes into eyes, please wash them with clear water immediately and see a doctor.
- Don't use rechargeable battery.
- Two batteries shall be of the same type.
- Obsolete batteries shall be disposed of properly.

Auto-restart function

- The unit is set with auto-restart function, which is set to OFF when the unit leaves factory. If you want to use the function, contact the technical service center.

Auto-restart function refers to the following contents:...

When the indoor unit is controlled by the remote controller, the unit will automatically remember the operation mode, set temperature and fan speed. If power cut or power-off occurs during operation, Auto-restart function will enable the unit to start automatically and operate in the previous mode set by the remote controller after power-on.

Indoor unit

Insert the power plug in the socket. Turn the power switch to ON position.

Warning

Confirm a firm connection by removing the dust on the power plug. Fire or electric shock may result from a plug with dust or socket in failure.

When the remote controller can't be used (emergency operation)

When the dry batteries in the remote controller are exhausted, or when the remote controller is in failure, you can use the emergency operation button on the unit to control the operation.

- 1 Press the emergency operation button.
 - Each press of the button enables the unit to change operation mode following the order of Cooling→Heating→Stop.

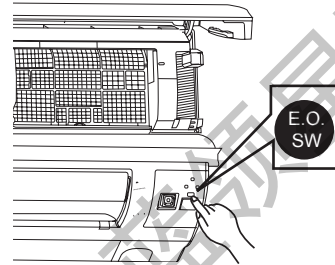

- The operation mode is indicated by the AREA lamp on the indoor unit as follows:

	Emergency cooling	Emergency heating	Stop
AREA	AREA	AREA	AREA
AREA lamp	■ L R □ light gray	□ L R ■ gray light	□ L R □ gray gray

NOTE:

- In emergency operation, AREA setting is not work.
- The operation is described as follows.
In the first 30 minutes, the unit only operates continuously without impact from room temperature. The fan speed is constant. After 30-minute operation, the unit status is as follows:

Operation mode	Cooling	Heating
Set temperature	24°C	24°C
Fan speed	Medium	Medium
Horizontal (vane)	Automatic	Automatic
Vertical vane	Front	Front

- 2 To stop the Emergency operation, press the Emergency operation switch.
Each press of the button enables the unit to change operation mode following the order of Cooling →Heating →Stop.

"I FEEL..." Auto Operation

In the mode of "I FEEL..." Auto Operation, one press of the button enables the room condition to reach optimum status.

When starting "I FEEL..." Auto Operation

■ Press  button.

At the time of displaying (Auto Operation), the air conditioner is automatically controlled to the optimum temperature.

When stopping

■ Press  button



About 15 minutes after the start of operation:

If you feel too hot:

■ Press  button to decrease the temperature.

Each press of the button decreases the temperature by about 1°C

If you feel too cold:

■ Press  button to increase the temperature.

Each press of the button increases the temperature by about 1°C.

At the time of not displaying  (Auto Operation), please press  button to set Auto Operation mode.
Each press of the button enables the unit to change operation mode following the order of  (Auto Operation) →  (Cooling) →  (Dry) →  (Heating).

Auto Operation mode

Auto Operation

The operation mode is automatically set to Cooling, Dry or heating based on the room temperature at initial operation. However, if the unit operates again within 2 hours after stopping, it will operate following the same set points with the previous operation. Once the set points are set, the operation will not vary with the room temperature. If you don't like the set points, you can press  button, then select proper set points.

Set points for "I FEEL..." Auto Operation

Room temperature at initial operation	Operation mode	Target temperature (initial status)
Over 25°C	Cooling	About 24°C
Below 25°C	Dry	—
Below 23°C	Heating	About 26°C

Note:

Cooling: When the room temperature is 2°C higher than the set temperature, the latter will not change. Because the air conditioner is operating to reach the target (set point) temperature. Meanwhile, please wait for room temperature to decrease to the temperature around the set one (+2°C), then you can change the set temperature.





Heating: When the room temperature is 2°C lower than the set temperature, the latter will not change. Because the air conditioner is operating to reach the target (set point) temperature. Meanwhile, please wait for room temperature to increase to the temperature around the set one (+2°C), then you can change the set temperature.

Manual operation (Cooling, Dry, Heating)

When selecting operation mode (Cooling, dry, heating)

1 Press  button.

2 Press  button to select operation mode.

Each press of the button enables the unit to change operation mode following the order of  (Auto Operation) →  (Cooling) →  (Dry) →  (Heating).

When stopping

■ Press  button.

Set the operation mode. Once you press  button, the air conditioner will operate following the set mode.



■ When changing set temperature:

- At the time of decreasing temperature, press  button. Each press of the button decreases about 1°C.
- At the time of increasing temperature, press  button. Each press of the button increases about 1°C.

When operating in Dry mode

- Unable to control temperature (temperature setup)
- Operate at the temperature slightly lower than room temperature.

Note:

- When the environmental temperature is too high, room temperature may not reach the set temperature due to excessive load in cooling operation.
- Heating principle for heat pump type air conditioner: The unit absorbs heat from outdoor air by refrigerant cycling, transmit the heat inside the room and heat up the air in the room. The heating capacity decreases with the temperature drop of outdoor temperature.
- If outdoor temperature becomes extremely low, please use the unit together with other heating equipment.

Notice for using air conditioner

Cooling: how to make an efficient cooling operation

1. Close the windows tightly, put down the curtain, and reduce sunshine amount.
2. Stick commercially available heat shielding film to the windows for reduction of sunshine heat.
3. The outdoor unit shall be installed in a place where the sunshine is absent.

Heating:

The warmth beneficial to health mainly depends on the temperature difference between indoor and outdoor environment! The set temperature for heating operation shall not differ from outdoor temperature excessively. Although it varies with the region, generally speaking, the set temperature can be set to 20°C~24°C.

Dry:

A humidity of 70% is a divergence point at which people feel comfortable. When people feel sultry, it indicates that there is a great number of vapor in the air, that is to say, the humidity is high. Humidity is concerned with temperature and airflow. Generally speaking, a humidity of 60%~75% in summer and that of 55%~70% in winter shall be the ideal condition at which people feel most comfortable.

MOVE EYE CONTROL OPERATION...Sensible temperature

- The proceed of the unit's temperature control is a general temperature control proceed, that accord to the temperature of wall, floor and room measured by MOVE EYE sensors (MOVE EYE control operation).
- When cancel MOVE EYE control, the general temperature control proceed will instead.

Starting MOVE EYE control

MOVE EYE control operation is activated when MOVE EYE button is pressed with a thin stick in manual COOL or manual HEAT mode.

Note:

MOVE EYE control operation is activated when the remote controller is first used following replacement of the batteries or resetting of the remote controller.

Cancelling MOVE EYE control

MOVE EYE control operation is cancelled when MOVE EYE button is pressed with a thin stick once again.

Note:

If the conditioner is turned OFF without cancelling MOVE EYE control operation, MOVE EYE control operation is activated the next time the air conditioner is turned ON.

MOVE EYE control operation

The sensors constantly measure the room and floor/wall temperatures to automatically adjust to the set temperature by estimating the temperature actually perceived by a person inside the room ("**sensible temperature**").

Advantages:

- The air inside the room is conditioned quickly to a comfortable condition.
- The room will not become too cold or hot even when the air conditioner is kept on for a long period.

MOVE EYE sensor

- When AREA setting is not activated, the sensing range of MOVE EYE Sensor differs depending on the installation location of the air-conditioner.

Installation position	Installation at left	Installation at center	Installation at right
Image of sensing range			
Direction of sensor	Left	Center	Right

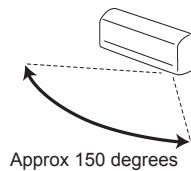

Refer to the description for slide switch setting. (Page 30)

- Install the front panel correctly after being removed for maintenance or service so that the floor/wall temperatures can be measured correctly.

AREA SETTING

When AREA have been setted, horizontal air flow (Horizontal Vane) can adjust automatically according to the temperature measure from the wall and floor.

AREA setting

- Press AREA button.
- Each time the button is pressed, the area is changed in sequence:

(AUTO) → (LEFT) → (RIGHT) → Cancel

MOVE EYE Sensor moves intermittenly, measuring the floor and wall temperature.

NOTE 1: AREA setting is only available during MOVE EYE control operation. (Refer to page 34)

NOTE 2: If AREA setting is canceled, the vertical vane returns to the previously set position before AREA setting.

NOTE 3: The horizontal air flow direction (WIDE VANE button), including horizontal SWING, can not be set during AREA setting.

Moving of horizontal air flow direction	<ul style="list-style-type: none"> • If AREA setting is set to AUTO in heating operation, the indoor unit automatically delivers warm air to the area where the floor/wall temperature is the lowest in the room. • If AREA setting is set to AUTO in cooling operation, the indoor unit automatically delivers cool air to the area where the floor/wall temperature is the highest in the room. <p>Ex.) In heating operation</p> <div style="display: flex; justify-content: space-around;"> <div style="text-align: center;"> <p>Day</p> </div> <div style="text-align: center;"> <p>Night</p> </div> </div> <p>The indoor unit delivers warm air detecting the cold area in the room.</p>
Indoor unit display	<p>Indication of AREA setting</p> <div style="text-align: center;"> </div>
NOTE	<ul style="list-style-type: none"> • The horizontal air flow direction changes if MOVE EYE Sensor detects approx.3 temperature difference. • In AUTO of AREA setting, both right and left lamps are lighted when the room is evenly air-conditioned. <div style="text-align: center;"> </div>

□ Not lighted

☀️ Lighted

Cancelling AREA setting

AREA setting is cancelled when the “cancel” is selected by pressing AREA button, or when WIDE VANE button is pressed.

Indoor unit installation location and air-conditioning area.		
Installation at left	Installation at center	Installation at right
<ul style="list-style-type: none"> • Be sure to set the side switch inside the remote controller to an appropriate position in accordance with the installed position of the indoor unit. If the switch is not set correctly, the air conditioner may not function properly. (Refer to Page 30) 		

AREA SETTING

AREA setting		To air-condition mainly the left area of the room.	To air-condition the entire room. The horizontal air flow direction and indoor unit display are switched according to the room temperature (floor/wall).	To air-condition mainly the right area of the room.
Remote controller button		Press AREA button to select LEFT	Press AREA button to select AUTO	Press AREA button to select RIGHT
Control range of horizontal air flow direction. The vertical air flow direction conforms to the setting on the remote controller (The horizontal air flow direction is controlled in this range.)	Installed at center			
	Installed at left			
	Installed at right			
Indoor unit display	AREA	AREA L R	AREA L R or L R or L R	AREA L R

获取更多资料

Air flow velocity and direction adjustment

Select your favorable fan speed and airflow direction

■ To change the airflow velocity, press the  button. (Lo)→(Me)→(Hi)→(SHi)→(Auto).

How to select fan speed:

Principle of the air conditioner: The greater the air volume, the more effective the energy saving, and the higher the noise. The air outlet temperature increases at cooling mode and decreases at heating mode. Therefore, selecting the fan speed of Lo enables you to get a quiet environment for rest. Selecting the fan speed of Hi or SHi enables you to get an effective energy saving.

■ At the time of changing vertical airflow direction, press  button.

Each press of the button enables the unit to change vertical airflow direction following the order of (1)→(2)→(3)→(4)→(swing)→(auto).

Air flow with swing

Swing operation enables the airflow to reach all corners of a room.

Recommended scope for vertical airflow direction

Usually, please turn to (auto).

Turn to position (1) in cooling or dry mode.

Turn to position (2) ~ (4) in heating mode.

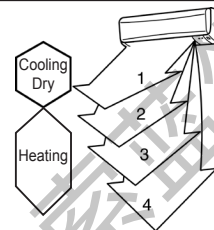

Movement of horizontal vane

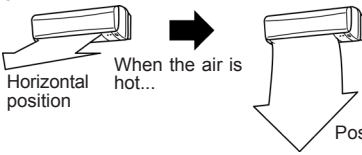
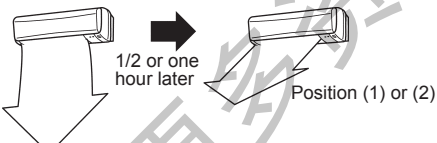
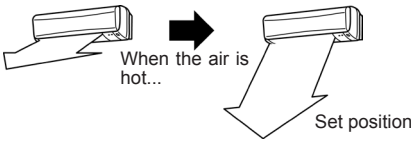
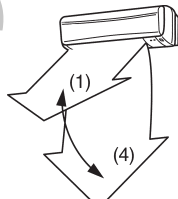
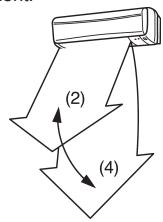



	Cooling/ Dry	Heating
AUTO	 <p>Horizontal position</p> <ul style="list-style-type: none"> The vane moves to the horizontal position after stopping swing. <p>Note: The airflow is higher than position 1.</p>	 <p>Start of heating Horizontal position</p> <p>When the air is hot... Position 4</p> <ul style="list-style-type: none"> After the air conditioner starts to operate, the vane stops in horizontal position. Once the temperature of the airflow from indoor unit is enough high, the vane will move to Set position 4. Once the air conditioner starts to operate, fan speed increases with the temperature rise of airflow from the indoor unit and until the set speed.
Manual	 <p>1/2 or one hour later Position (1) or (2)</p> <p>The airflow direction is set to position (2), (3) or (4)</p> <ul style="list-style-type: none"> When the air conditioner operates for about one hour, the vane moves to position (1) or (2) automatically. Press the button Vane on the remote controller to change the airflow direction back to original set point. 	 <p>Start of heating Horizontal position</p> <p>When the air is hot... Set position</p> <ul style="list-style-type: none"> After the air conditioner starts to operate, the vane stops in horizontal position. Once the temperature of the airflow from indoor unit is enough high, the vane will move to Set position. Once the air conditioner starts to operate, fan speed increases with the temperature rise of airflow from the indoor unit and until the set speed.
Swing	 <p>(1) (4)</p> <ul style="list-style-type: none"> The vane moves intermittently between position (1) and (4). The vane stays at position (1) and (4) for a moment. 	 <p>(2) (4)</p> <ul style="list-style-type: none"> The vane moves intermittently between position (2) and (4). The vane stays at position (2) and (4) for a moment.

Note:

- To adjust the airflow direction by the air conditioner. Moving the vertical vane or horizontal vane by hand may cause failure.
- When the operation mode changes to mode "(auto)", the horizontal vane changes to different positions automatically mentioned above.

Air flow velocity and direction adjustment

Enable the airflow not to blow to you directly.

To change airflow direction	When to use the function?	Cooling/Dry	Heating
<p>VANE Press  button, two seconds later, the horizontal vane moves to horizontal position reversely.</p>  <p>Horizontal Position</p>	<p>You can use the function to prevent the airflow leaving the indoor unit from blowing to you directly.</p> <ul style="list-style-type: none"> The airflow may blow to you directly due to special room contour. <p>VANE Press  button again to enable the vane to return to the previous set position.</p>	<p>The vane moves to the horizontal position, three minutes later, the air conditioner begins to operate in Cool or Dry mode.</p> <ul style="list-style-type: none"> Press FAN  button again to enable the vane to return to the previous set position. About three minutes later, the air conditioner begins to operate in Cooling or Dry mode. 	<p>The vane moves to the horizontal position, three minutes later, the air conditioner begins to operate in Heating mode.</p> <ul style="list-style-type: none"> Sometimes the air above the ground is not hot enough. Set the horizontal vane to position Auto or blow down. Press VANE  button again to enable the vane to return to the previous set position. About three minutes later, the air conditioner begins to operate in Heating mode.

Note:

- If you press **FAN**  button to enable the airflow not to blow to you directly, the compressor of the air conditioner will stop to operate for three minutes during operation of the air conditioner.
- The air amount of the air conditioner will reduce until the compressor is going to be operated again.

■ Press button to change airflow direction (left/right).

Each press of the button enables the unit to change the vertical vane angle following the order of



Blow with swing.

Blow with swing enables the airflow to reach each corner of the room.

Econo Cool operation

Enable this mode to enjoy healthy, comfortable and power-saving cooling operation.

Please operate as follows in manual cooling mode

■ Press **ECONO COOL**  button.

Select the air conditioner operating in  (Econo Cool) control mode, which controls the horizontal vane to swing periodically and automatically according to the outlet temperature.

Moreover, the set temperature increases by 2°C automatically based on cooling operation.

When quitting Econo Cool operation

■ Press **ECONO COOL**  button again.

- In Econo Cool operation, press **VANE**  button or change operation mode to quit Econo Cool button, or button and Timing ON/OFF button can be used further.
- Airflow speed button, Extreme Hot or Extreme Cold button and Timing ON/OFF button can be used continuously.





What is Econo Cool?

Swinging airflow (variable flow) feels cooler than constant airflow, therefore, even if the set temperature is set to a higher one by 2°C you can feel comfortable and power is saved.

Sleep Operation

If you want to sleep, please select the function in Cooling mode.

When selecting Sleep mode

- 1 Press  button when the unit is operating.
Fan speed is changed to Auto. Changing fan speed enables you to quit Sleep mode.
- 2 Press  button or  button to set a temperature in Sleep mode.
After setting of the temperature in Sleep mode, press  button again to show the temperature set in previous mode.

When quitting Sleep mode

- 3 Press  button again.
Sleep mode can be quitted by pressing button or changing operation mode.
Sleep mode can be used together with TIMER ON/OFF.

Sleep mode description

At the time of pressing  button, the display darkens, fan speed is changed to Auto mode automatically, and the air conditioner operates with low noise.

- When the air conditioner operates in Sleep mode, cooling or heating capacity is not enough, thus, you can quit Sleep mode.

Cooling/Heating mode

- The air conditioner operates at the temperature set prior to pressing Sleep mode button, about 30 minutes later, the temperature is changed to that set in Sleep mode.

Change of the set temperature

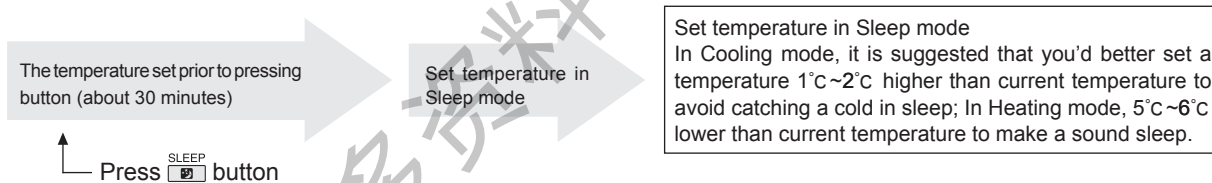

If ON-Timer is enabled to activate Sleep mode, the air conditioner will operate at the temperature set in Sleep mode.

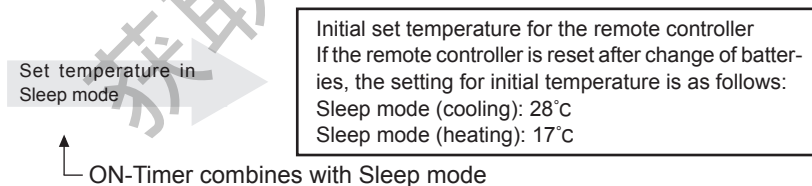

Set temperature for ON-Timer



Timer operation (ON-Timer and OFF-Timer)

You can preset the air conditioner to ON-Timer and OFF -Timer at the time of sleeping, going home or getting up.

How to set ON-Timer

- 1 Press  button.
- 2 Press ON-Timer button "", the figure flashes.
Set time for the timer by pressing Time button (increase) and (decrease).
Each press of button increases the set time in 10 minutes intervals and each press of button decreases the set time in 10 minutes intervals.

QUIT ON-Timer

- 1 Press  button.

Combination of ON-Timer and OFF-Timer

Combine ON-Timer with OFF -Timer. The unit will operate first at the earlier set time.



(The mark "↑ ↓" shows operation order of timer.)

- If the current time is not set, timer operation will be disabled.

Note:

If main power supply is switched off or power failure occurs during timer operation, timer setting will be canceled.

How to set OFF-Timer

- 1 Press  button.
- 2 Press OFF-Timer button "", the figure flashes.
Set time for the timer by pressing Time button (increase) and (decrease).
Each press of button increases the set time in 10 minutes intervals and each press of button decreases the set time in 10 minutes intervals.

Quit OFF-Timer

- 1 Press Press OFF-Timer button "", the figure flashes.
button.

When the air conditioner is not used for a long time

Not used for a long time

- 1 Enable the fan to run for 3~4 hours so as to dry the inside of the air conditioner.
 - Before fan operation, set to Cooling operation mode and select highest set temperature..
- 2 Switch off the power supply and remove the power plug.

Warning

Be sure to remove the power plug when the air conditioner is not used for a long time.

Fire may result from possible dust deposit.

- 3 Take out the batteries in the remote controller.

Note:

When the remote controller is not used for a long time, be sure to take out all batteries in the remote controller to avoid fluid leakage.

To be used again

- 1 Clean the filter and return it to the unit.
(Refer to page 41)
- 2 Be sure to confirm whether the air inlets and air outlets of indoor and outdoor units are covered.
- 3 Confirm whether the earth wire is connected firmly.

Warning

Must be grounded.

The earth wire should not be connected to gas pipe, tap water pipe, lightning rod and telephone line.

If you don't connect the earth wire as required, electric shock may result.

Maintenance

Before cleaning

- 1 Switch off the power supply and remove the power plug.

Warning

When cleaning the unit, you have to stop unit operation by removing the power plug and switch off the power supply. Because fan blades in high-speed rotation may hurt you.

Cleaning for indoor unit

- 1 Clean with soft dry cloth
 - If there is distinct smear, use a piece of cloth soaked with neutral detergent to clean the unit.
 - Never use gasoline, volatile oil, friction powder or disinfectant. Otherwise, they may damage the unit.
 - The front panel may fall down after being lifted over horizontal position. If it falls down, refer to Step 3 in Cleaning for Front Panel.

Front panel cleaning

- 1** Press and loose the clips at both ends of the front panel, lift the panel until you hear a click (1). Hold the hinge, take up the front panel horizontally, pull out the hinge forward and remove the panel (2).

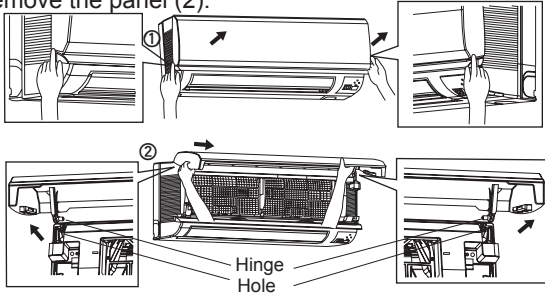

Warning

- Don't pull out the front panel forcibly and drop it, or the front panel will be damaged.
- At the time of removing/installing the front panel, don't stand on unstable support, or you may be injured.

- 2** Use a piece of soft and dry cloth to clean the panel or wash it with water. After washing with water, use a piece of soft and dry cloth to remove water on the panel.

- If the panel is too dirty, use a piece of cloth soaked with warm solution of neutral detergent to clean the front panel.
- Don't clean the panel with gasoline, volatile oil, mixed solvent, friction powder or disinfectant, and with brush or hard sponge.
- Don't place the panel in hot water, direct sunshine and let it face a heater for a long time(over two hours). Otherwise, the front panel will be discolored and distorted.

- 3** Hold both ends of the front panel with hands, place the panel horizontally, then put the hinge in the groove at the top of the indoor unit until you hear a click. After that, close the front panel, press the three positions shown as follows with hands.



Catechin Filter Cleaning

Catechin Filter Cleaning (Cleaning is done once two weeks)

- 1** Pull out the catechin filter slightly.

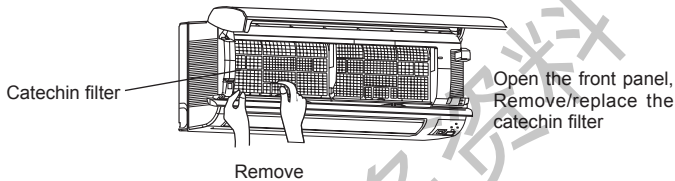

Note

During disassembly of the catechin filter, take care not to touch the metallic part of the indoor unit, as you may be scratched.

- 2** Use a cleaner to clean or use water to wash.
- Don't clean the catechin filter with brush or hard sponge, otherwise, the catechin filter will be distorted.
 - If the catechin filter is too dirty, use warm solution mixed with neutral detergent to wash the deodorizing catechin filter.
 - Don't use hot water (about over 50°C) to wash the catechin filter to avoid distortion.

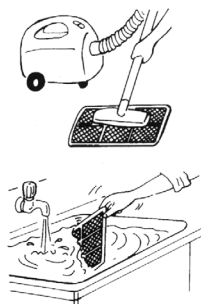

- 3** After washing with water, the catechin filter can't be used until it is dried.

- Don't dry the catechin filter under sunshine or with fire.

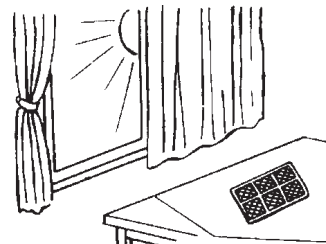

- 4** Installing the catechin filter.

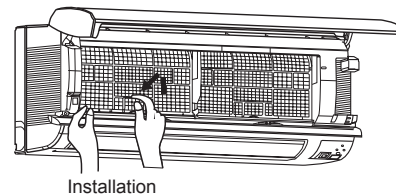

Please check the following items before connecting a serviceman

Is there a failure?	Check point
The air conditioner can't operate.	<ul style="list-style-type: none"> • Is the power supply turned on? • Is the fuse blown? • Is ON-Timer set?
The horizontal vane can't operate.	<ul style="list-style-type: none"> • Are the horizontal vane and vertical vane installed in the indoor unit correctly? • Is the protective screening of the fan distorted?
Indoor cooling is not enough.	<ul style="list-style-type: none"> • Is the temperature setting correct? • Is the filter clean? • Is the air inlet or air outlet of the indoor or outdoor unit covered? • Are the doors and windows in room opened?
The indoor unit gives off odor.	<ul style="list-style-type: none"> • Is the filter clean?

Is there a failure?	Check point
The remote controller has no message to display or darkens. The indoor unit has no response to the signal from the remote controller.	<ul style="list-style-type: none"> • Are batteries exhausted? • Is the polarity of a battery placed correctly? • Are buttons on the remote controller of other electric appliance pressed?

If the air conditioner can't still operate after the above items have been checked, please stop using the machine and contact the specialty shop or technical service center for help.

Please pay attention to the following condition before asking a serviceman for repair.

- In a room decorated with electronic fluorescent lamp, the signal from the remote controller may be unacceptable.
- In circumstances with weak radio wave, the air conditioner may disturb the signal acceptance of broadcast or TV, thus, the affected equipment may need a magnifier.
- When thunder appears, you have to stop operation and remove power plug or turn off the power supply. Otherwise, there is a risk of damaging the electrical part in the air conditioner.

When you think trouble occurs

Is there a failure?	Answer (it's normal)
The air conditioner can't operate within 3 minutes after you restart the machine.	<ul style="list-style-type: none"> • In accordance with the microcomputer's display, it means the protection of the air conditioner, please wait.
A crack is heard.	<ul style="list-style-type: none"> • The noise results from the expansion/shrinkage of the front panel due to temperature change.
The air out of the indoor unit has a odor smell.	<ul style="list-style-type: none"> • The air conditioner may absorb the peculiar smells from wall, carpet, furniture and clothes, then mix them with air for blowout. • Is the Deodorizing filter cleaned? • Please clean the Deodorizing filter.
Fan stops operation in dry mode.	<ul style="list-style-type: none"> • During dry operation, the unit uses the same refrigerant circuit with the cooling operation. Dry operation can't decrease the room temperature in order to reduce the humidity. Therefore, sometimes the compressor may stop operation while indoor unit fan stops running, which is to prevent the condensed water drop on heat exchanger from evaporating again.
Voice similar to current is heard.	<ul style="list-style-type: none"> • This is a voice from refrigerant flowing inside the air conditioner. • This is a voice from the flowing of condensed water drop inside the heat exchanger.
Voice similar to air bubble is heard.	<ul style="list-style-type: none"> • This is a voice from the ejection of water flowing inside the drainage hose when the outdoor air is absorbed in the hose and when a soot absorption machine or a vent fan is activated. If the outside airflow is strong and blown into the drainage hose, you can hear the voice too.
Fog is blown out from the indoor unit outlet during operation.	<ul style="list-style-type: none"> • The fog results from quick condensation between moisture in the air and cold airflow from indoor unit outlet.

Is there a failure?	Answer (it's normal)
Snapping can be heard from indoor unit.	<ul style="list-style-type: none"> • This is a voice from the switching (ON and OFF) of compressor or fan.
Hiss can be heard from indoor unit.	<ul style="list-style-type: none"> • This is a voice in which the air conditioner starts or stops refrigerant flowing.
The airflow direction changes during operation. The remote controller can't adjust the movement of the horizontal vane.	<ul style="list-style-type: none"> • When the air conditioner operates in cooling mode, if the air is blown downwards for one hour, the airflow direction is set to (1) or (2) automatically, which is to prevent condensed water drop from dropping.
There is a water leakage in outdoor unit.	<ul style="list-style-type: none"> • In cooling operation, pipe or pipe connector is condensed with water due to cooling.
The horizontal vane and vertical vane pauses to swing and then starts to swing again.	<ul style="list-style-type: none"> • The condition appears so that normal blowing with swing is enabled for the horizontal vane and vertical vane.
Cooling in room can't fully meet the demand.	<ul style="list-style-type: none"> • Using exhaust fan or liquefied cooking utensils can lead to insufficient cooling with great load. • Extreme high outside air temperature can lead to poor cooling effect.
White smoke is blown out from the outdoor unit.	<ul style="list-style-type: none"> • Defrosting operation brings the steam similar to white smoke during heating operation.
The wind can't be blown out immediately at the beginning of heating operation.	<ul style="list-style-type: none"> • Preparing for blowing out warm enough wind. Please wait for a minute.
The air conditioner stops for about ten minutes during heating operation.	<ul style="list-style-type: none"> • Dissolving the frost on outdoor unit. Defrosting operation will finish in ten minutes, please wait for a minute. (Frosting happens when the air temperature is low and the humidity is high)
Fizzle is heard sometimes.	<ul style="list-style-type: none"> • This is a voice in which the air conditioner changes the flow direction of refrigerant.

Removal and inspection

Check and repair

- The performance of the air conditioner decreases due to long-term service and internal dirt.
- Odor may result from using condition, or poor drainage of condensed water may result from dust deposit.
- The check and repair are different from common ones. You'd better ask for special technical service. Please contact the specialty shop or technical service center for help.

Operation noise should be also considered.

- Don't place articles at the outlets of outdoor unit. For the placement will reduce the efficiency and increase noise in operation.
- If there is abnormality in operation, please contact the specialty shop or technical service center for help.

When you want to remove the machine

- When removing and reinstalling the air conditioner due to room enlargement or relocation, please ask for special technical service.

⚠ Warning

Don't reappear or remove the air conditioner by yourself.
Maloperation may cause fire, electric shock, injury by unit drop and water leakage. If the air is mixed in the refrigerant, pressure may increase to lead to breakage. Thus, please contact the specialty shop or technical service center for help.

Safety precautions for Installation

1. For the sake of safety, please pay attention to the following safety precautions

⚠ Warning

Users are not allowed to install the machine by themselves.

- Improper installation may cause fire, electric shock, water leakage or injury from machine falling.
Please contact the specialty shop or technical service center for help.

The machine should be installed in a place which can support its weight.

- If the machine is installed in a place which is not solid enough, there will be a risk of injury from machine falling.

Cables between indoor and outdoor unit shall be connected properly as specified, and connecting terminals for the cables be fixed firmly without being affected by external force.

- Poor connection or fixture may cause fire.

Installation shall be implemented properly based on installation instructions

- Improper installation may cause fire, electric shock, water leakage or injury from machine falling.

Please ventilate room in the event of refrigerant leakage during installation.

- Exposure of refrigerant to open flame can produce toxic gas.

⚠ Warning

In the event of installation or removing, any substance other than refrigerant shouldn't be mixed into the refrigerant circuit.

- If air is mixed in the circuit, system pressure will increase to cause breakage.

When pumping down the refrigerant, stop the compressor before disconnecting the refrigerant pipes.

- If the refrigerant pipes are disconnected while the compressor is running and the stop valve is open, air could be drawn in and the pressure in the refrigeration cycle could become abnormally high. This could cause the pipes to burst or injury.

When installing the unit, securely connect the refrigerant pipes before starting the compressor.

- If the compressor is started before the refrigerant pipes are connected and when the stop valve is open, air could be drawn in and the pressure in the refrigeration cycle could become abnormally high. This could cause the pipes to burst or injury.

Electrical work should be performed according to installation instructions. Be sure to use special power supply of circuit.

- Fire or electric shock may result from insufficient capacity or incomplete construction for the power supply circuit.

The electrical cover of indoor unit or the service board should be installed correctly.

- If the cover and the service board are not installed well, fire or electric shock may result due to entrance of water and dust.

Safety precautions for Installation

⚠ Warning
<p>Attached or specified parts should be used for installation construction.</p> <ul style="list-style-type: none"> Improper parts may cause fire, electric shock, water leakage or injury from machine falling.
<p>For the power supply circuit, connection in the middle section, extension of power cord or use of multi-cable socket are not suggested.</p> <ul style="list-style-type: none"> Poor contact, poor insulation or overload may cause electric shock.
<p>The connection wire from the middle section of connection wire/signal connection line should not be adopted.</p> <ul style="list-style-type: none"> Misoperation of the unit will occur, causing the unit not to operate normally.
<p>Grounding construction shall be done.</p> <ul style="list-style-type: none"> The air conditioner socket shall be connected with special earth wire. Electric shock may result from no grounding or poor grounding. Don't connect the earth wire to gas pipe, tap water pipe, lightning rod or telephone earth wire.
<p>Don't install the unit in a place where combustible gas may leak.</p> <ul style="list-style-type: none"> In case the combustible gas leaks and accumulates around the unit, explosion may result.
<p>A leakage protector shall be installed.</p> <ul style="list-style-type: none"> If the leakage protector has not been installed, an electric shock may result.
<p>Be sure to implement drainage and piping construction in terms of installation instructions.</p> <ul style="list-style-type: none"> If there are improper drainage and piping construction or inclined indoor unit, furniture will be wet and contaminated by water drop from indoor unit.
<p>Please install the unit in terms of national rules of wiring.</p>
<p>After installation construction, be sure to confirm whether there are positions in which refrigerant gas leakage occurs.</p>
<p>If the power cord is damaged, be sure to replace it with special power cord or with special components bought from manufacturer or service center.</p>
<p>Moreover, if you have no notion of something, contact the specialty shop for help.</p>

2. Attention for R410A refrigerant systems

2-1 Using R410A refrigerant air conditioners

⚠ Caution										
<ul style="list-style-type: none"> Use C1220 copper phosphorus (for copper and copper alloy seamless pipes) to connect the refrigerant pipes. Make sure the insides of the pipes are clean and do not contain any harmful contaminants such as sulfuric compounds, oxidants, debris, or dust. Use pipes with the specified thickness. Use ester oil, ether oil, alkylbenzene oil (small amount) as the refrigeration oil applied to the flared sections. If mineral oil is mixed in the refrigeration oil, oil deterioration may result. Do not use refrigerant other than R410A refrigerant. If another refrigerant is used, the chlorine will cause the oil to deteriorate. Use the following tools specifically designed for use with r410a REFRIGERANT. The following tools are necessary to use R410A refrigerant. Contact your nearest dealer for any questions. 										
<table border="1"> <thead> <tr> <th colspan="2">Tools (for R410A)</th> </tr> </thead> <tbody> <tr> <td>Gauge manifold</td> <td>Flare tool</td> </tr> <tr> <td>Change hose</td> <td>Size adjustment gauge</td> </tr> <tr> <td>Gas leak detector</td> <td>Vacuum pump adapter</td> </tr> <tr> <td>Torque wrench</td> <td>Electronic refrigerant charging scale</td> </tr> </tbody> </table>	Tools (for R410A)		Gauge manifold	Flare tool	Change hose	Size adjustment gauge	Gas leak detector	Vacuum pump adapter	Torque wrench	Electronic refrigerant charging scale
Tools (for R410A)										
Gauge manifold	Flare tool									
Change hose	Size adjustment gauge									
Gas leak detector	Vacuum pump adapter									
Torque wrench	Electronic refrigerant charging scale									
<ul style="list-style-type: none"> Be sure to use the correct tools. If dust, debris, or moisture enters the refrigerant lines, refrigeration oil deterioration may result. Do not use a charging cylinder. If a charging cylinder is used, the composition of the refrigerant will change and the efficiency will be lowered. 										

2-2 Precautions for devices that use R410A refrigerant

⚠ Caution						
<ul style="list-style-type: none"> When installing or moving the air conditioner, use only the specified refrigerant (R410A) to charge the refrigerant lines. Do not mix it with any other refrigerant and do not allow air to remain in the lines. Air enclosed in the lines can cause pressure peaks resulting in a rupture and other hazards. 						
<table border="1"> <thead> <tr> <th colspan="2">MSZ-YE18VA-H1</th> </tr> </thead> <tbody> <tr> <td>Liquid pipes</td> <td>φ6.35mm(Thickness 0.8mm)</td> </tr> <tr> <td>Gas pipes</td> <td>φ12.7mm(Thickness 0.8mm)</td> </tr> </tbody> </table>	MSZ-YE18VA-H1		Liquid pipes	φ6.35mm(Thickness 0.8mm)	Gas pipes	φ12.7mm(Thickness 0.8mm)
MSZ-YE18VA-H1						
Liquid pipes	φ6.35mm(Thickness 0.8mm)					
Gas pipes	φ12.7mm(Thickness 0.8mm)					
<ul style="list-style-type: none"> Do not use pipes thinner than those specified above. Do not share the vacuum pump with R22 refrigerant systems. 						

Safety precautions for Installation

3. Selection of installation location

3-1 Indoor unit

- A place where inlet/outlet airflow shall not be obstructed.
- A place where blown cold air can reach each corner of the room.
- The maximum distance and maximum height difference between indoor and outdoor unit: Refer to Extreme Pipe Length.
- A solid wall where vibration can't occur.
- A place where direct sunlight is avoided.
- A place where drainage becomes easy.
- A place where the unit is 1 meter apart from radio and TV or 3 meters apart from antenna. (Otherwise, the TV image will be disturbed or noise may occur.)
- A place where the unit is far away from fluorescent or incandescent lamp (Otherwise, wireless remote controller may in maloperation).
- A place where it's easy to install and remove the air filter freely.

3-2 Outdoor unit

- A place with less influence from gale and heavy snow. If the unit is installed in a region of heavy snow, measures shall be taken for prevention of heavy snow (You are advised to install a covering or base frame).
- A place with good ventilation and less dust.
- A place with less rain or less direct sunlight.
- A place where operation noise or blown hot air can't bother neighbor. In order to reduce operation noise or vibration, you shall install the unit in a solid frame.
- A place where there is no leaked combustible gas. When installing the unit in a higher place, you have to fix the foot of the unit.
- Be sure to install the unit horizontally.
- Easy for maintenance and repair.

The installation location of the outdoor unit should be at least 3 m away from the antennas for TV sets, radios, etc. In areas where the reception is weak, provide greater space between the outdoor unit and the antenna of the affected device if operation of the air conditioner interferes with radio or TV reception.

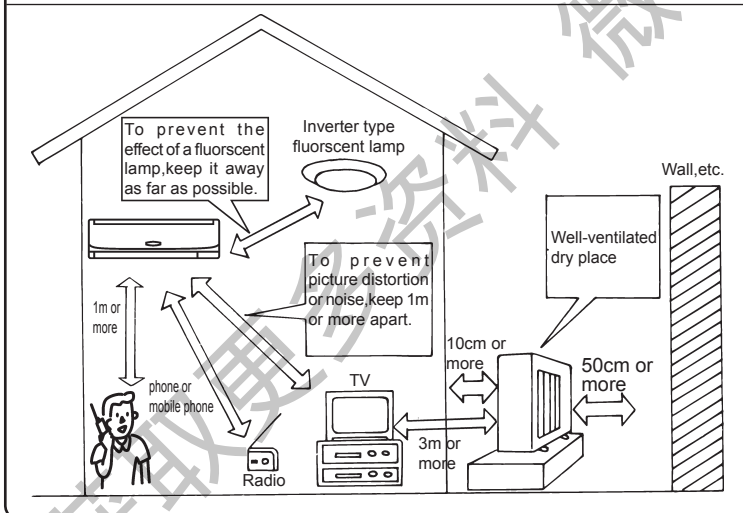

⚠ Notice

Don't install the air conditioner in the following places.

- A place where plenty of machine oil is used.
- Seashore with a great deal of salt.
- A place where there are hot spring and sulfurized gas.
- A place where there is a problem with other environmental atmosphere.
- A place where there are volatile, corrosive and combustible chemicals.
- A place where cranes and ships move.

Installation instructions

1. Installation diagram and accessory

Packing list

(Before installation, users are advised to verify the amount of parts based on the packing list)

Indoor Unit			Outdoor unit		
Installation No.	Part name	Amount	Installation No.	Part name	Amount
	Indoor unit	1		Outdoor unit	1
①	Installation plate	1			
②	Screw 4 x 25mm	5			
③	Battery (No.7)	2			
④	Remote controller	1			
⑤	Felt strap	1			
	Guarantee	1			
	Operating and installing instructions	1			
			A	Connection cable	1
			B※	Connection pipe	1
			C※	Wall hole sleeve	1
			D※	Wall hole cover	1
			E※	Pipe strap	1
			F※	Extension drainage hose	1
			G	Drain Plug	1
			H※	Putty	1

※ This components need to be purchased.

Flared joint

- The unit is equipped with flared joints at indoor/outdoor unit side.
- As shown in the figure below, refrigerant pipe is used to connect indoor/outdoor unit.

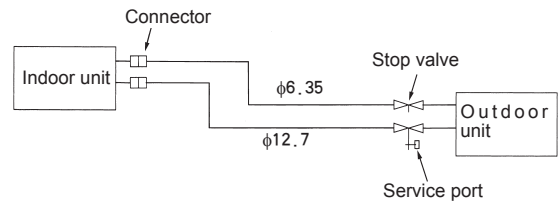

Limit	
Pipe length	12m
Height difference	8m
Amount of bends	10 pieces

• Adjustment of refrigerant . . . If the pipe length exceeds the scope in the table below, refrigerant (R410A) should be supplemented. (Filling refrigerant to the outdoor unit with refrigerant shall be subject to the following pipe length.)

Pipe length	Type	Dosage of refrigerant
Over 6 meters	MSZ (Inverter)	30g × (pipe length (m)-6)

• Note: Excessive extension of piping will cause cooling and heating capacity to decrease.

Note:

- (1) Don't use the drainage pipe connector and rubber stopper in cold areas. Failure may result from drainage freezing.

Steps for installing drainage pipe

- (1) Select a drain hole in the base for draining and connect the drainage pipe connector to the hole.
- (2) Block residual drain holes in the base with rubber stopper.
- (3) Connect the drainage pipe to the connector. Keep the drainage pipe to tilt downwards to make a smooth draining.

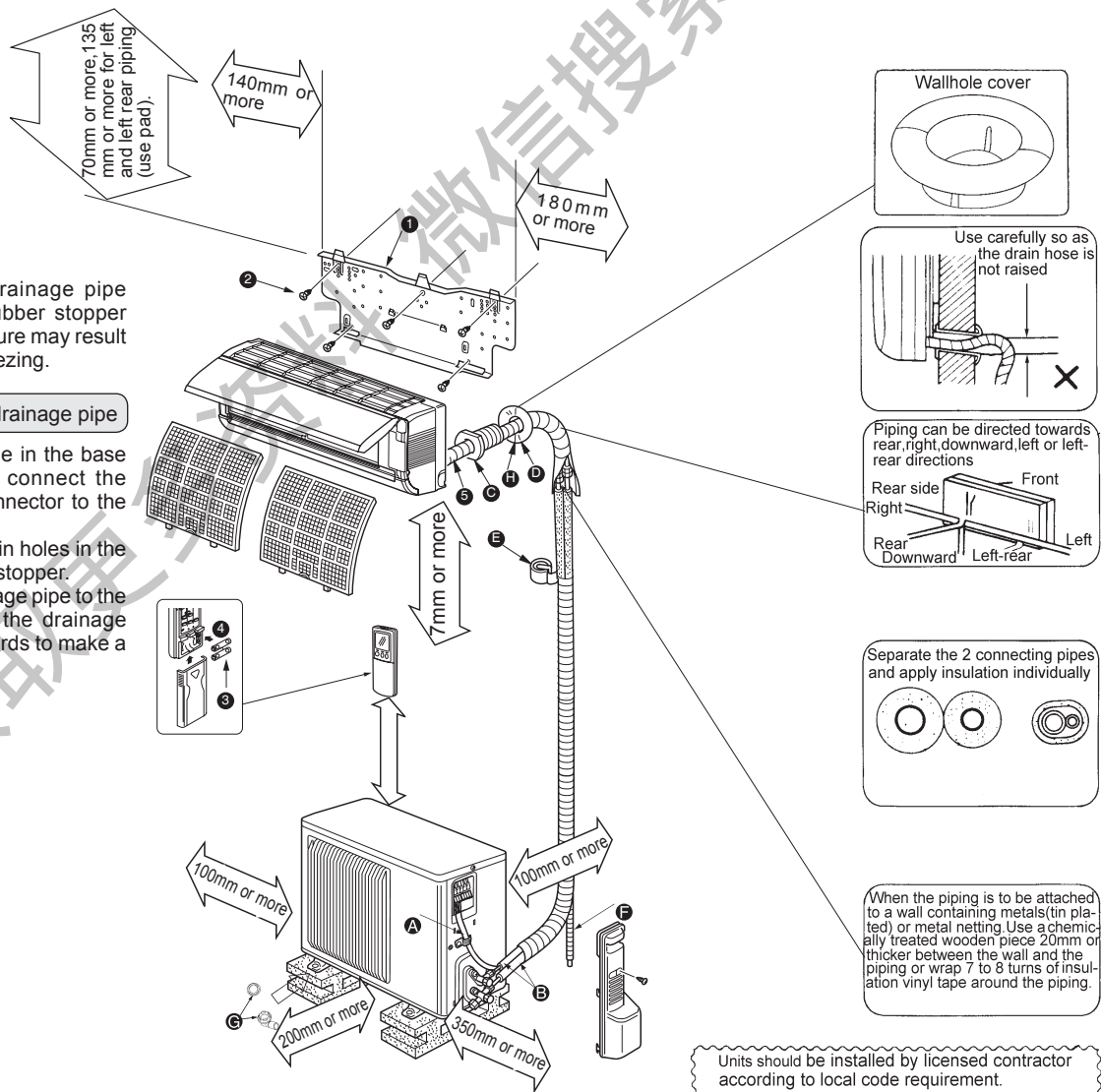

Units should be installed by licensed contractor according to local code requirement.

Installation instructions

Installation dimension

(Unit: mm)

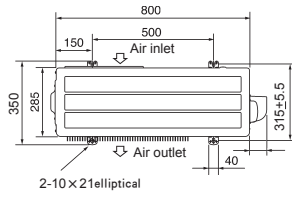

1-1 HOW TO SWITCH OVER <REMOTE CONTROLLER>

- ① The details of slide switch.
Remove the front lid.
- ② Be sure to set switch inside the remote controller to an appropriate position in accordance with the installed position of the indoor unit. If the switch is not set correctly the air-conditioner not function properly. (refer to the Page 30)

NOTICE:

- If the indoor unit uninstalled more than 50cm away from the side walls, cabinets or other nearby objects, set the side switch to the "center" position.
- ③ Insert the two batteries (AAA) in the place.
- ④ Reattach the front lid.
- ⑤ Press the RESET button with a pen, etc.

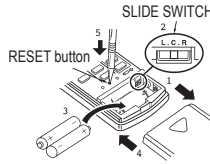

2. Installation for indoor unit

2-1 Fixing of mounting plate

- Look for a structural part (such as a pole) so that you are sure to fix the mounting panel horizontally. If the indoor unit declines, the furniture will be wet and contaminated by water drop from the unit.

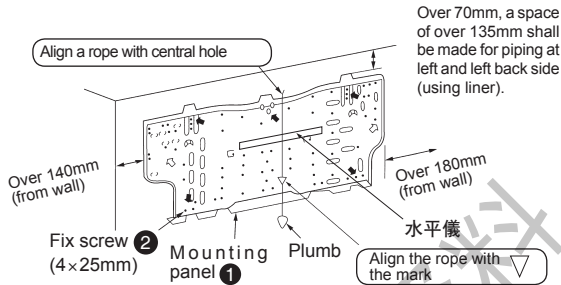

In order to avoid slight vibration of the mounting plate, Holes marked with ◀ should be fixed, and parts marked with ▶ should be also fixed as possible.

When using expansion screws buried into cement wall, you shall use elliptical holes of 11 x 20 and 11 x 26 with 45cm apart from each other to fix the mounting panel. If the expansion screw is too long, use short screws sold in market.

2-2 Drill holes in wall

- ① Confirm the hole position in wall.
- ② Drill a hole (diameter: 65mm) tilting slightly downwards from inside to outside.
- ③ Insert wall hole sleeve ㉞ in the wall hole.
- ④ Embed the putter filler ㉟ between wall hole and sleeve.

Confirm the hole position

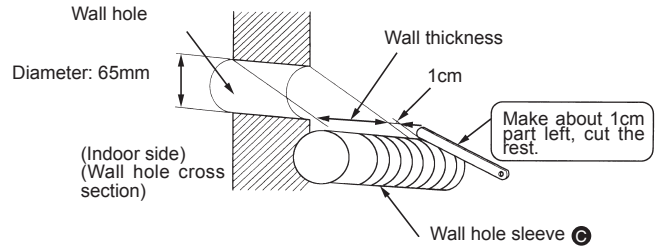
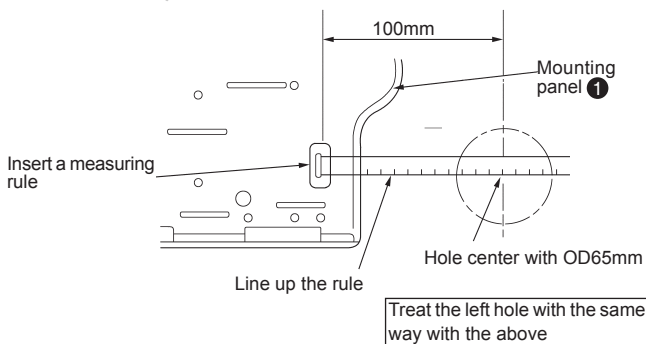

Always use the wall hole sleeve ㉞, which prevents the connection wires between indoor and outdoor unit from contacting the metallic parts inside wall and rodent pest from occurring.

2-3 Specifications for power cord and connection wires

- Use special cables for air conditioner.

Power cord length (Length stretching from left/length stretching from right)	0.65/1.35m
Connection wires between indoor and outdoor unit.	With a section area of 1.5mm ² . YZW type cable

- Lead out a power cord from the left or right bottom of the indoor unit.

Warning

- Each air conditioner should be equipped with special power supply line. Power supply specification should accord with national regulations and be installed with independent switch.
- Don't cut off the power cord and connect it to other lines, or fire may occur.

Don't bind the rest power cord together, keep it in good order as shown below.

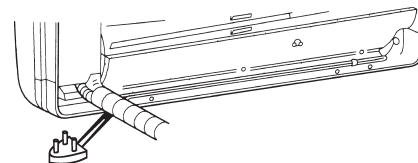

2-4 Connection of indoor/outdoor wires

- ① Open the front panel.
- ② Remove the screw which fixed electrical cover to open it.
- ③ Pass the indoor/outdoor unit connecting wire from the back of the indoor unit, then connect it to the terminal bed. Connect the earth wire to the marked grounding terminal on the electrical box.
- ④ Place the electrical cover securely.

(Figure 1)

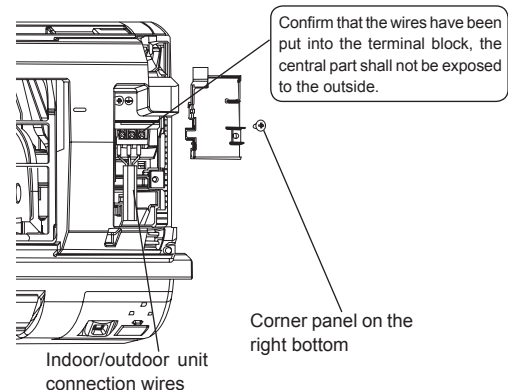

Installation instructions

Warning

- Cables between indoor and outdoor unit shall be connected in good order using specified cables and connecting terminals be fixed well without being affected by external force. Fire may result from poor connection or fixture.
- Electrical cover shall be fixed well, otherwise, fire or electric shock may result from entry of dust and moisture.
- Be sure not to make wrong connection.
- Electric shock may result from wrong grounding.

Note

- Tighten terminal screws to avoid looseness.
- After tightening of the screws, pull the wires slightly to verify whether they are tightened.
- If the wires are not connected to the terminal block, the air conditioner can't operate correctly.

Warning

- Wires between indoor and outdoor terminal block shall be marked with number for corresponding connection.



MSZ

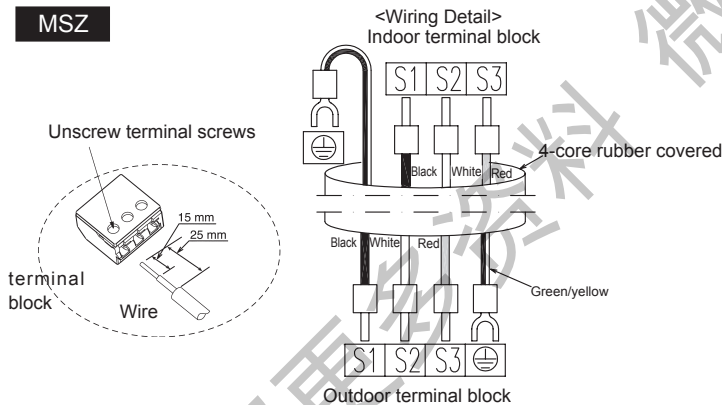

Warning

- Neutral line, live line and earth wire inside power socket shall be connected as shown in figure reliably without wrong connection and internal short circuit.
- Fire may result from wrong connection.

Power supply check Diagram for power socket in user's home

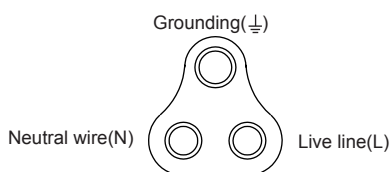

2-5 Auto restart function

When the air conditioner is controlled by the remote controller, indoor unit electrical board will memorize operation mode, set temperature and fan speed. If there is a power-off during operation, Auto restart function is enabled to restart the air conditioner after recovery of power supply. If the air conditioner operates in the mode of "I FEEL CONTROL" before power-off, the mode will be memorized. In "I FEEL CONTROL" mode, air conditioner operation depends on indoor temperature at restarting.

How to set Auto Restart Function

- ① Remove the front panel
- ② Remove the screws of electrical cover.
Remove the electrical cover
- ③ Remove the connector of blade motor from CN151.
Remove the wires of blade motor inside the electrical terminal block.
Remove the temperature sensor from CN111, CN112.
Remove the MOVE EYE sensor from CN110.
- ④ Pull out the electrical board and disconnect the resistance JR07 on it.

Operation

- ① The operation setting is still reserved at power-off.
- ② 3 minutes after recovery of power supply, the air conditioner will restart automatically according to the memory.

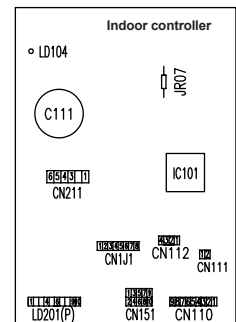

Note:

- 10 seconds after operating the remote controller, the operation setting will be reserved.
- When the Auto ON/OFF timer is activated, the timer setting will be cancelled in the event of power-off or power failure. As Auto Restart function is equipped inside the types, once the power is recovered, the air conditioner will start to operate three minutes later.
- If the air conditioner is turned off by the remote controller before power-off, Auto Restart function will be disabled due to power button's OFF status in the remote controller.
- In order to prevent impulse current from affecting the power supply, please arrange a sequence to start other household appliances to avoid simultaneous power-on.

2-6 Piping work

- Be sure to place drainage hose under refrigerant pipe.
- Don't upheave or bend the drainage hose.
- Don't bind up the hose by pulling it.
- Be sure to bind up the drainage hose with commercially available insulated material when the hose goes through room.
- Wrap pipes and drainage hose with felt tape ⑤ and put them into the pipe keeping section behind the indoor unit.

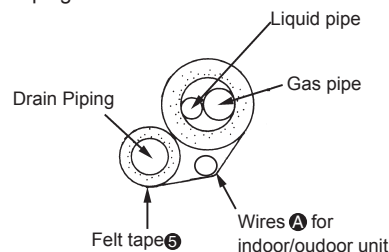

Installation instructions

Laying pipes backwards, rightwards and downwards

Piping

- Pipe layout
- Put refrigerant pipe and drainage pipe together, wrap them with band.

Take care not to raise the drainage hose.

Cut this part when connecting pipe downwards.

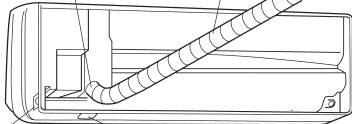

Cut this part when connecting pipe rightwards.

Cut this part when connecting pipe downwards.

- Insert the refrigerant pipe and drainage pipe into the wall hole sleeve ③, hang the indoor unit's upper half on the mounting panel ①.
- Move the air conditioner right and left to check if it is hung on the panel ① firmly.
- Push the unit's lower half into the mounting panel ①.

Lay pipes leftwards or rear leftwards.

- Pipe layout
- Put refrigerant pipe and drainage pipe together, wrap them with band first and then with felt tape ⑤.

Take care not to raise the drainage hose.

Cut this part when connecting pipe leftwards.

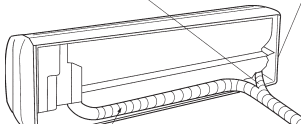

Felt tape ⑤ (Pipe band ⑤)

Use a tape to fix the end of the felt tape ⑤.

Wrap the pipe from pipe end with felt tape ⑤ (The folded part of the felt tape ⑤ shall be one third of its width)

Refitting for drainage hose

The drainage hose should be refitted in the event of piping leftwards and rear leftwards. Otherwise, water dripping may result.

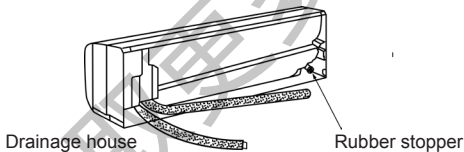

1 The rubber stopper at the rear right of indoor unit.

Remove the rubber stopper by grasping the sharp lug.

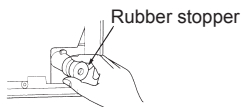

2 Remove the drainage hose at the rear left side of the indoor unit.

Pull out the drainage hose by grasping the handle knob shown by arrow in the direction

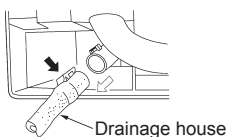

3 Slip the rubber stopper into the position in which the drainage pipe is installed at the rear of indoor unit.

Use an allen key to press the stopper into the joint of the drain plate.

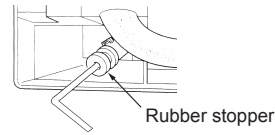

4 Connect the drainage hose to the corresponding connection position at the rear right of indoor unit.

Insert the drainage hose in the joint of the drain plate. Be sure to confirm if the hose is clamped into the prominent detent.

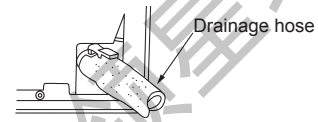

Connection between the refrigerant pipe and extension pipe

If extension pipes or wires have been buried into a wall, please perform piping as described in the following key points.

- ① Hook the mounting plate ① with indoor unit's upper part. After considering inclusion of the pipe and placing the unit as possible as close to the left, cut off a piece of packing material (used as liner) to lock the rear lug, raise the indoor unit as shown in right figure.

- Connect the refrigerant pipe and extension pipe ②.
- Cut off a part of packing material (used as liner)**
- Lock the rear lug**

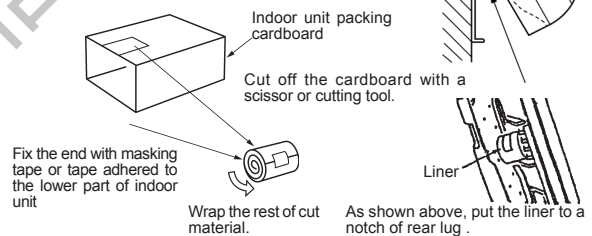

Installation of indoor unit

- Pass the pipe through the wall, hang and install the unit on the mounting plate ①, then push in the unit until a click is heard.

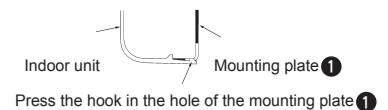

2-7 Laying drainage pipe

In order to make a smooth drainage, the drainage pipe shall be connected tilting downwards. (figure 1)
Don't connect the pipe as shown in figure 2-3.

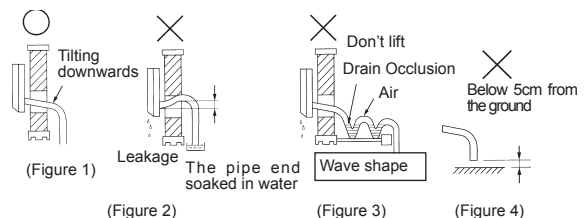

If it is not long enough for the drainage hose installed at the indoor unit, you can use the hose ⑦ in accessory for connection. When the hose goes through room, be sure to bind up the drainage hose with commercially available insulated material.

Installation instructions

3. Installation of outdoor unit

Connection between indoor and outdoor unit

- Connect the wires from the indoor unit to the terminal block correctly.
- Take care not to enable the wires to contact pipe.

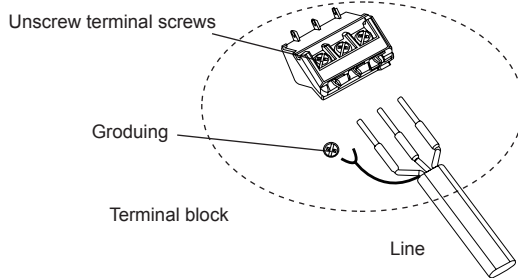

⚠ Note

- Don't make wrong connection. The air conditioner can't operate normally in case of wrong connection.
- Tighten the screws to avoid looseness.
- Pull the wires slightly to verify whether they are tightened.

Be sure to use this wire clip to fix indoor/outdoor unit's connection wire **A** in good order.

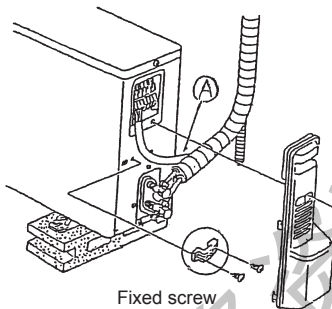

⚠ Note

Fix the service board of outdoor unit well. Otherwise, fire and electric shock may result from entry of dust and moisture.

⚠ Note

- The mounting surface of the air conditioner should be solid enough to bear the weight. The bearing capacity shall not be lower than actually born weight (at least 200kg/m²).
- The mounting surface is decorated with wooden, metallic or non-metallic structure. Corresponding measures like reinforcement, support and anti-vibration shall be taken in case of insufficient strength.
- Installation rack shall be such a fixture that the air conditioner can be fixed securely on the mounting surface.
- Confirm the diameter and depth of the mounting hole for the fixture based on hardness of the mounting surface material, select applicable expansion bolt to ensure unit's stability, firmness and reliability.
- Try to avoid rainy days, windy and snowy days as well as thundery days during installation. If necessary, relevant measures shall be taken to protect people from injury.

4. Complete indoor/outdoor unit connection and perform test run

4-1 Piping connection

① Indoor unit piping

Connect liquid and gas pipes to the unit.

- First, align with the center, tighten the pipe nut with hand until you can't proceed.
- Refer to the following torque table, use two wrenches to tighten the indoor unit side connection pipe connector. Take care not to tighten it excessively to avoid damaging the flared part.

Pipe diameter		Torque tightened	
mm	Inch	N · m	kgf · cm
6.35	1/4	13.7-17.7	140-180
12.7	1/2	49.0-56.4	500-575

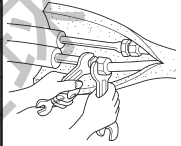

⚠ WARNING

- When installing the unit, securely connect the refrigerant pipes before starting the compressor.

② Outdoor unit connection

As the same connection with that of indoor unit, connect the pipe to the outdoor unit stop valve (two or three-way) pipe connector.

- Tighten the connector with the same torque as that of indoor unit by torque wrench or common wrench.

Heat insulation and wrapping band

① Pipes and valves connected at side of indoor unit should be heat insulated.

② All pipes starting from the outdoor unit's pipe entrance shall be wrapped with band **E**.

- Fix the end of band **E** with tape.
- If the pipe goes through ceiling, toilet or other locations with high temperature and high humidity, please wrap the pipe with commercially available heat insulated band to avoid condensation.

4-2 Vacuumizing and leak detection test

Vacuumizing

Connect the refrigerant pipe(liquidnd gas) between the indoor and out door unit

Remove the stop valve's service cap at the gas pipe of outdoor unit
(Vacuumizing can't be done without removing the cap)

When vacuum pump is recommended to be used

Connect the manifold valve with gauge and vacuum pump to the stop valve's service port at the gas pipe of outdoor unit

Run the vacuum pump(vacuumize the pipe over 15 minutes)

Check the vacuum with the manifold valve with gauge, close the valve and stop the pump.

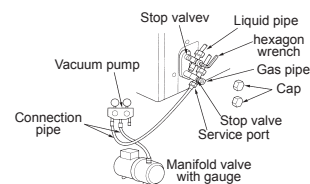

Remove the manifold valve with gauge from the stop valve service port quickly.

Open all the stop valves at liquid and gas pipes, or performance reduction or failure may result.

It's unnecessary to add refrigerant if pipe length is within the scope.

It's necessary to add proper refrigerant if pipe length exceeds the scope

Screw the service cap securely.

Screw the caps of two stop valves securely.

Make a leakage detection test.

Installation instructions

	Tightening torque	
	N · m	kgf · cm
Service cap	13.7-17.7	140-180
Stop valve cap	19.6-29.4	200-300

4-3 Test run

MSZ INVERTER

- Before the test run, recheck if there is wrong connection. Wrong connection may hinder normal operation or lead to fusing as well as malfunction.
- Perform the test run by emergency button. At the time of pressing the button, the machine begins to operate in cooling mode based on optional mode for 30 minutes. The thermostat will be disabled within the 30 minutes. After the duration, the machine starts emergency operation in cooling or heating mode at the set temperature of 24°C
- Test run shall be performed in the following process.

Operation process

- Press the emergency button
 - First press of the button enables cooling operation in emergency. After running 30 minutes.
 - Second press of the button enables heating operation in emergency.
 - Third press of the button disables the operation.
 Each press of the emergency button enables the unit to operate following the order of ①→②→③ repeatedly.

	model		
①	emergency cooling	AREA L (light) R <input type="checkbox"/> (gray)	
②	emergency cooling	AREA <input type="checkbox"/> L (gray) R (light)	
③	stop	AREA <input type="checkbox"/> L (gray) R <input type="checkbox"/> (gray)	

NOTE:

In emergency operation AREA setting is not work.

Make sure to receive the signal from the remote controller

After pressing the ON/OFF button of the remote controller, please confirm whether there is beep from the indoor unit. Then press the button again to turn off the unit.

Under the control of remote controller, the unit will quit the emergency operation when receiving the signal from the remote controller.

- In order to protect the compressor, the outdoor unit will not be enabled even if the air conditioner restarts three minutes after stopping operation.

4-4 Notice for users

- Based on operating instructions, please describe the way to adjust and control temperature, disassembly of air filter and vertical vane, way of cleaning and precautions in operation.

5. Relocation and maintenance after installation

5-1 How to install front panel

- Set the horizontal vane to position No.3 (page 37) before installing the front panel.
- Insert the bottom side of front panel under the horizontal vane.
- Fix the top of the front panel securely.
- Press the agraffe of front panel and fix the front panel on the air conditioner.

5-2 Remove the indoor unit

Pull out the bottom part of indoor unit from the mounting panel.

Loosen two corner parts

As shown below, pull the left and right corner part of indoor unit downwards and forwards and loosen the hook.

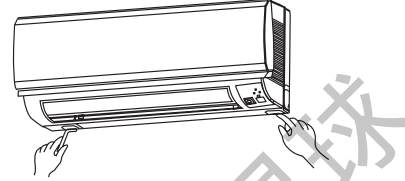

If the above methods can't be adopted

If the above methods can't be adopted, remove the front panel, insert a hexagon wrench into left and right square hole, then push it upwards. The hook will be loosened when the indoor unit bottom is pressed.

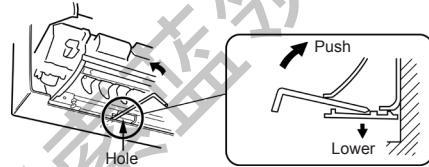

5-3 Supply of refrigerant

- Connect a gas bottle to the service port of stop valve(three way).
- Purge the pipe or hose using the refrigerant from the gas bottle.
- Supply the refrigerant with specified amount during air conditioner operation in cooling mode.

⚠ Note

- During supply of the refrigerant, don't place the gas bottle upside down, or problems may result.

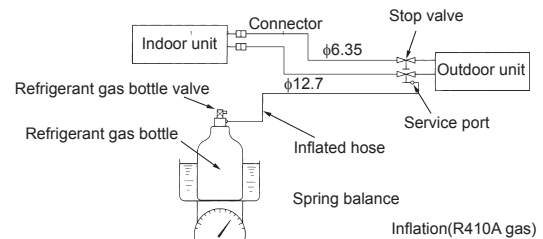

In order to keep high pressure in gas bottle, heat the bottle with warm water (40°C) in cold weather. But don't heat it with fire or steam.

Note:

- An indoor wiring diagram is stuck inside indoor unit front panel.
- Outdoor wiring diagram is stuck on outdoor unit electric control box.

5-4 How to recycle refrigerant

- Be sure to use a pressure gauge.
- Enable a cooling operation first.
- Then, close the valve (liquid valve) at high pressure side completely with the readings of 0-0.05MPa (about 30-40s) in pressure gauge, finally close the valve (gas valve) at low pressure side to stop operation immediately.
- You can't remove the connection pipe until you ensure the closure of the two valves (liquid and gas) and power-off.

⚠ WARNING

- When pumping down the refrigerant, stop the compressor before disconnecting the refrigerant pipes. The compressor may burst if air etc. get into it.

Specifications

Model	MSZ-YE18VA-H1
Electric shock proof protection	I Type
Power supply	220V~50Hz
Cooling capacity (W)	5000(1250~5200)
Heating capacity (W)	6100(1100~8100)
Power input of cooling (W)	1920(240~2170)
Power input of Heating (W)	2080(200~3150)
Cooling rated current (A)	9.4
Heating rated current (A)	9.7
Medium cooling capacity (W)	2400
Medium heating capacity (W)	3000
Power input of medium cooling (W)	540
Power input of medium heating (W)	650
Heating capacity in low temperature (W)	5850
Power input of heating in low temperature (W)	2690
Air flow volume (cooling/heating) (m ³ /h)	612/640
Refrigerant charging (g)	1500
Indoor noise cooling (dB(A)) (SHi/Lo)	43/32
Indoor noise heating (dB(A)) (SHi/Lo)	40/31
Outdoor noise (cooling/heating) (dB(A))	50/51
Indoor net weight (kg)	10
Outdoor net weight (kg)	36
Indoor size: Height × Width × Depth (mm)	295×834×252
Outdoor size: Height × Width × Depth (mm)	550×800*×285
Highest work pressure of discharge	4.15MPa
Highest work pressure of suction	1.64MPa
Maximum work pressure of heat exchanger	4.71MPa
Limit pressure of accumulator	1.94MPa

※ Adding the service board is 869.

Note:

- ① Guaranteed operating range:

		Indoor	Outdoor
Cooling	Upper limit	32°C DB	43°C DB
		23°C WB	-
	Lower limit	21°C DB	21°C DB
		15°C WB	-

		Indoor	Outdoor
Heating	Upper limit	27°C DB	24°C DB
		-	18°C WB
	Lower limit	20°C DB	-8.5°C DB
		-	-9.5°C WB

- ② The noise value is measured under the environment of laboratory (No background noise) before product's leaving factory.
- ③ The standard applied to the product: GB/T7725 IEC 60335-1 IEC 60335-2-40 IEC 62233

获取更多资料 微信搜索蓝领星球

 **MITSUBISHI ELECTRIC CORPORATION**

TOKYO BLDG., 2-7-3, MARUNOUCHI, CHIYODA-KU, TOKYO, 100-8310, JAPAN

WG79A464H01