





**MITSUBISHI  
ELECTRIC**  
SPLIT-TYPE AIR CONDITIONER  
分體掛壁式房間空調器

# 使用說明書

## OPERATING INSTRUCTIONS

MSD-LD23VD-H1

 <b>警告</b>	由於處置錯誤將造成死亡、重傷或財產損失的可能性很大。
 <b>注意</b>	由於處置錯誤，可能造成空調機不能正常使用或造成損失。
 <b>WARNING</b>	Incorrect handling could cause a serious hazard, such as death, serious injury, property loss etc. with a high probability.
 <b>CAUTION</b>	Incorrect handling could make the conditioners not working normally or causing damage.

## 目 錄

安全事項	1
各部件名稱	5
操作前的準備工作	7
“I FEEL...”(體感...)自動運轉	9
用戶自己選擇運轉模式時(製冷・除濕・送風)	11
風速・風向的調節	13
超遠送風	15
涼感運轉(健康・舒適・省電運轉)	16
定時器設定(定時關・定時開)	17
長期不使用時	18
室內機組的清理	19
茶精清新網的清理	20
在請維修人員之前，請再次檢查以下項目	21
當您認為「發生故障？」時	22
安裝・移機・檢查	24
技術性能表	25

## CONTENTS

SAFETY PRECAUTIONS	26
NAME OF EACH PART	30
PREPARATION BEFORE OPERATION	32
"I FEEL..."AUTO OPERATION	34
MANUAL OPERATION (COOL, DRY, FAN)	36
AIR FLOW VELOCITY AND DIRECTION ADJUSTMENT	38
LONG OPERATION	40
ECONO COOL OPERATION (HEALTHY, COMFORT, ECONOMICAL OPERATION)	41
TIMER OPERATION(OFF TIMER-ON TIMER)	42
WHEN THE AIR CONDITIONER IS NOT GOING TO BE USED FOR A LONG TIME	43
MAINTENANCE	44
CLEANING THE CATECHIN FILTER	45
BEFORE CONTACTING THE SERVICEMAN, CHECK THE FOLLOWING AGAIN	46
WHEN YOU THINK THAT TROUBLE HAS OCCURED	47
INSTALLATION, RELOCATION AND INSPECTION	49
SPECIFICATIONS	50

非常感謝您選用三菱電機房間空調器。

- 為了確保正確安全地使用本機，在使用前，務必請先閱讀過說明書。讀過以後請妥善保存，以備必要時查閱。
- 購買機器時，須在出售店收取記載有「購買日期・店名」的有效證明。
- 顧客請不要自己安裝機器(自行安裝，將不能保證安全和功能)。

**Thank you very much for purchasing this Mitsubishi room air conditioner.**

- To use this unit correctly and safely, be sure to read this instruction manual before use. Keep this manual carefully for later reference.
- Be sure to receive a guarantee card from your dealer and check that the purchased data and shop name, etc. are entered correctly.
- This air conditioner should not to be installed by the customer (Safety and performance functions cannot be assured).



# 安全事項

- 使用前，一定請先詳讀此「安全事項」。
- 這裏所示的注意事項，是有關安全的非常重要的內容，一定請遵守。

文中所用“符號”的意思如下。

	絕對不可做。
	一定請按指示做。
	一定要接地綫。
	一定請拔下電源綫插頭。
	禁止踩到室內/室外機組上面或在它們上面堆放東西。
	請小心觸電的危險。
	禁止插進指頭或棒條等。

- 閱讀後，請和安裝說明書一起收藏在使用者容易發現的地方。

## 禁止在放置或使用揮發性、腐蝕性、可燃性化學制品的環境中使用空調。

- 在室內使用揮發性、腐蝕性、可燃性化學制品(如二甲苯、香蕉油、甲醇等)期間，必須禁止使用空調。
- 室內裝修油漆未干，必須打開門窗，進行通風，等房間內各種稀釋劑氣體揮發散盡，方可使用空調。
- 否則會引起機器腐蝕、變形，甚至引起火災。

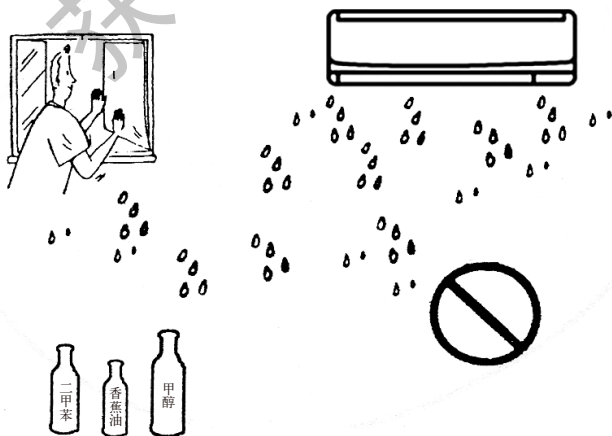

## 警告

### 禁止充電或解剖電池或將其扔入火中。

- 可能導致液體泄露，火災或爆炸。



### 如果鹼性電池內液體弄污皮膚或衣服，請用清水衝洗。

- 如果鹼性電池內液體弄污皮膚或衣服，請用清水衝洗并立即向醫師諮詢。

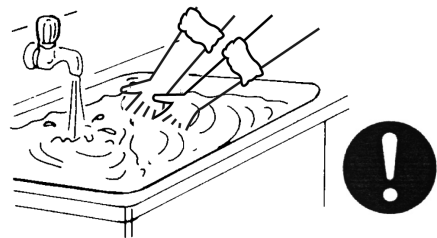

### 同時更換2節電池。

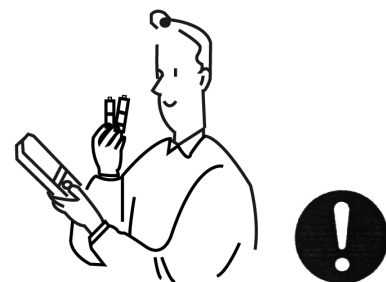

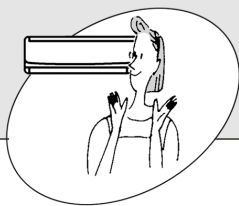

# 安全事項

## 警告

### 使用時禁止開關電源。

- 可能因打火導致火災。
- 必須使用遙控器關閉組后才可以切斷電源。

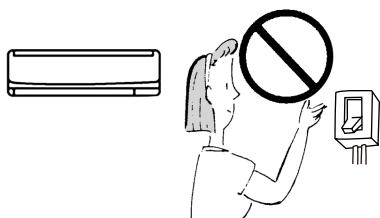

### 禁止用水洗刷空調機。

- 機器中如果進水，會降低絕緣性能，有發生觸電的危險。

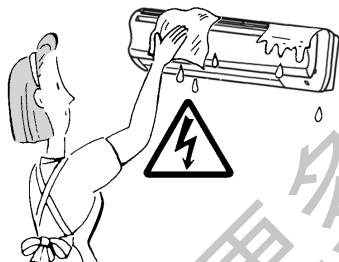

### 發覺異常時(燒焦味等)，關閉空調并切斷電源。

- 如果機組在異常情況下繼續運轉，可能導致火災、故障等。請與銷售商聯系。

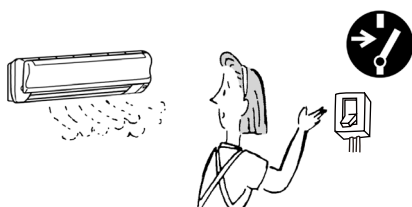

### 禁止手指或木條等插入通風口。

- 因風扇高速旋轉，可能導致人身傷害。
- 兒童應當受到監護，禁止玩弄空調器。

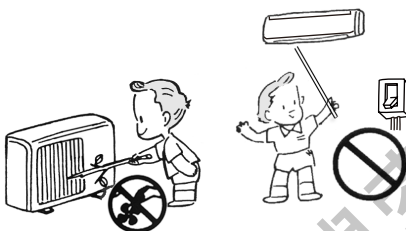

### 用戶不可自己進行修理或移設。

- 因為若處理不當，將可能引起火災、觸電、機器掉落傷人或漏水。請與出售店或技術服務中心聯系。

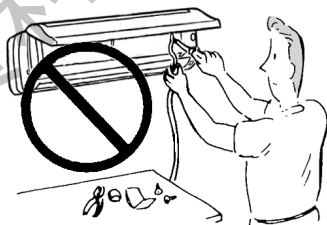

### 不要自己安裝機器。

- 因為若安裝不當，將可能引起火災、觸電、機器掉落傷人或漏水。請與出售店或技術服務中心聯系。

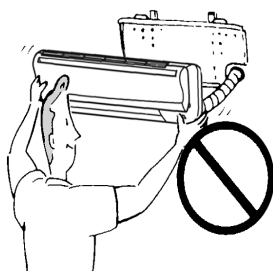

### 在拆卸空氣過濾網時，小心不要碰到室內機組的金屬部分。

- 有被刮傷的可能。

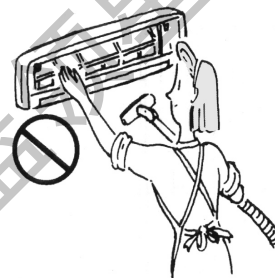

### 清潔機組時，關閉空調并切斷電源。

- 因為運轉中，有高速旋轉着的風扇可能傷人。

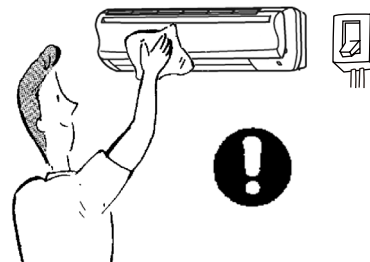

### 禁止用潮濕的手去操作開關。

- 有觸電的危險。

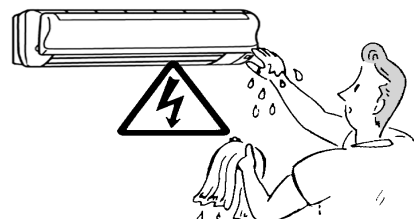

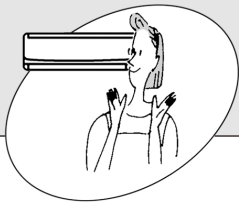

# 安全事項

## 警告

不要長時間讓冷風直吹肌膚。

- 可能會損害身體健康。

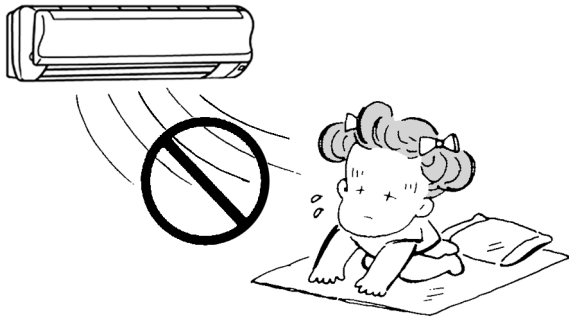

裝、卸面板時、禁止站在不穩固的腳台上。

- 可能跌倒受傷。

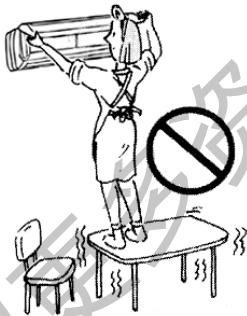

禁止用殺蟲劑・可燃性噴霧材料噴吹。

- 可能引起火災、機身變形。

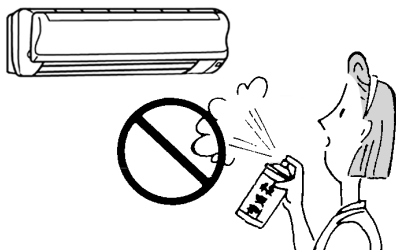

和燃燒器具一起使用時，應該時常換氣，保持充足的通風。

- 可能產生氧氣不足的現象。

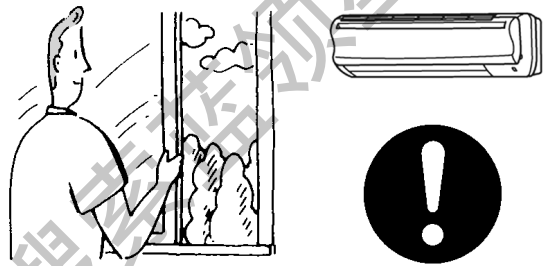

禁止燃燒器具放在風直接吹到的地方。

- 可能引起燃燒器具的不完全燃燒。

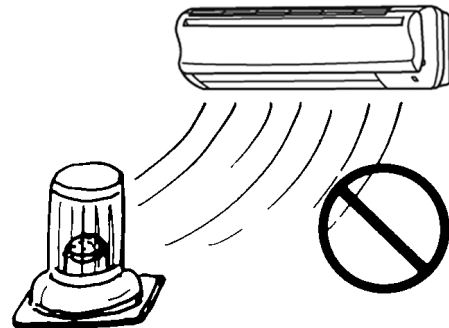



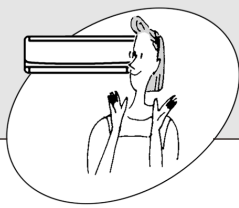

# 安全事項

## 警告

### 機組長期不用時請切斷電源。

- 否則，機組集塵可能導致火災。

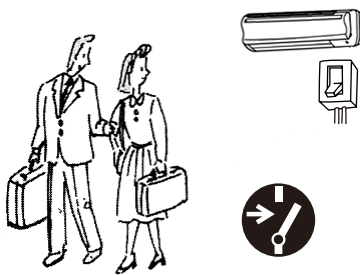

### 禁止站到室外機組上去，或在上面堆放東西。

- 可能跌下受傷。

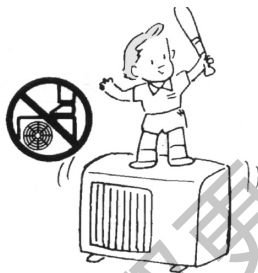

### 安裝台如果已陳舊不堪，不可置之不理。

- 機組有翻倒傷人的可能。

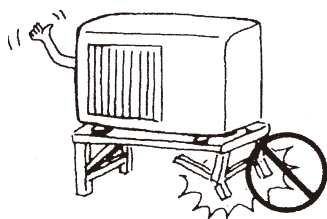

- 安裝機器，請與購買機器的出售店或技術服務中心聯系。

### 必須接地線。

- 空調插座應連接有專門接地線，地切綫勿接到煤氣管、自來水管、避雷針導綫、電話接地綫上。
- 如果没有接地綫或地綫没有連接好，可能引起觸電事故。
- 在使用前請務必確認是否有接地綫或接地綫是否按要要求連接。



### 某些安裝場所(例如濕氣高的地方等)，須安裝漏電斷路器。

- 若不裝漏電斷路器，便可能有觸電的危險。



### 禁止安裝在有可能泄漏腐蝕性、可燃性氣體的地方。

- 萬一發生漏氣而聚集在機組周圍時，便有發生爆炸或損壞機器的危險。



### 排水口須保證能順利排水。

- 如果有排水不良狀況，機組將可能滴水而浸濕弄污家具。



## 注意

### 禁止開着門窗，及在高濕度狀況下作長時間的運轉。

- 開冷氣時，若在高濕度(80%以上)下作長時間連續運轉，空調機可能有冷凝水滴下，從而浸濕弄污室內家具。

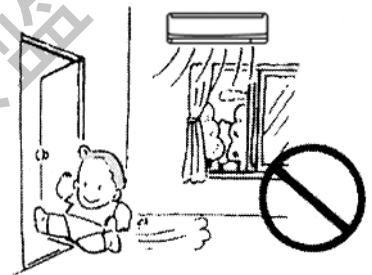

### 禁止當其它特殊用途。

- 不能作為保存精密機器、食品、動植物、美術品的用途。  
因為有降低保存品質的可能。

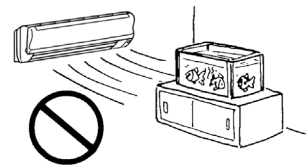

### 禁止在風直接吹到的地方放置動植物。

- 可能對動植物有不良影響。

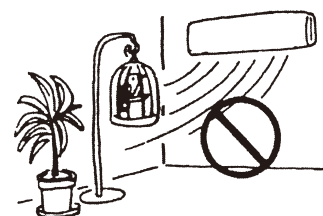



# 各部件名稱

## 室內機組

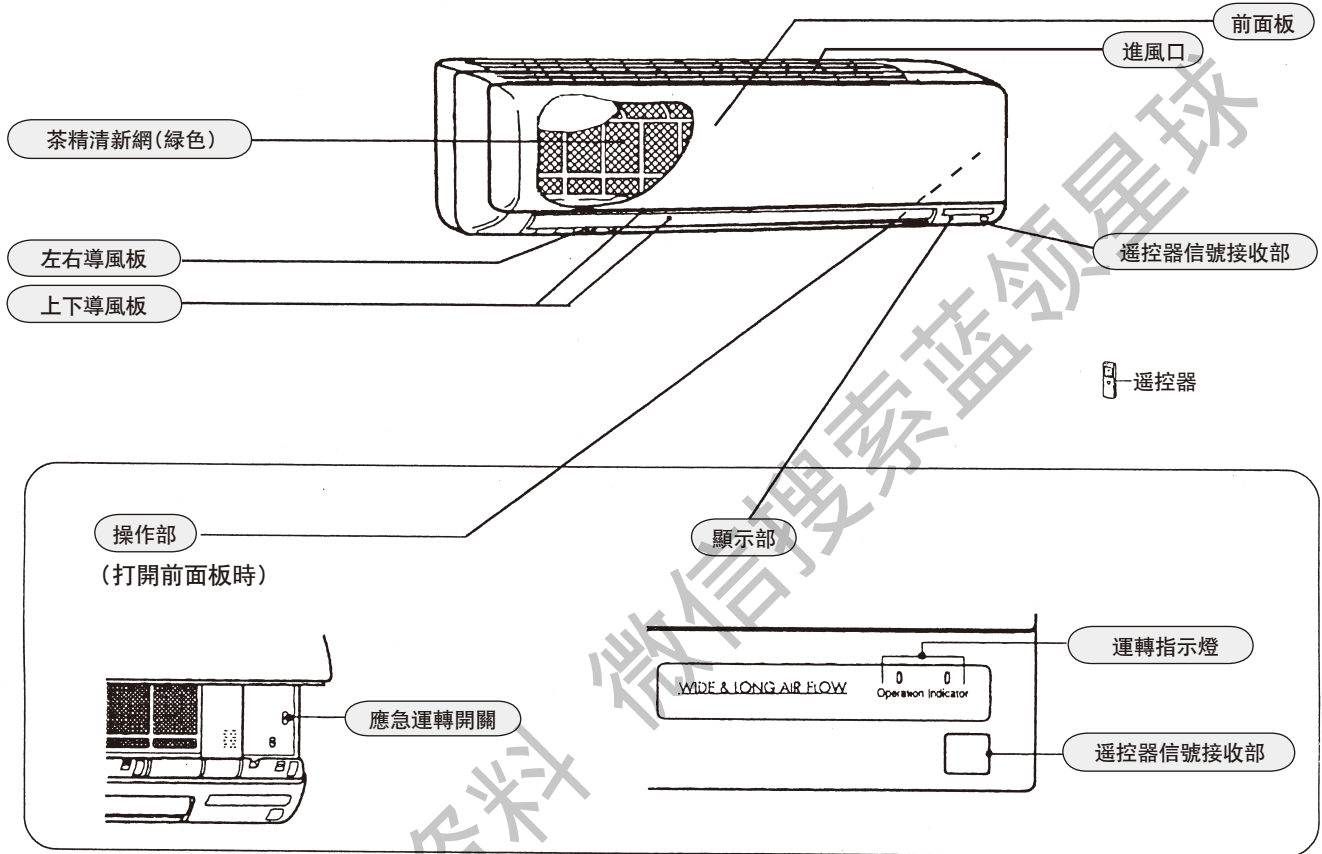

## 室外機組

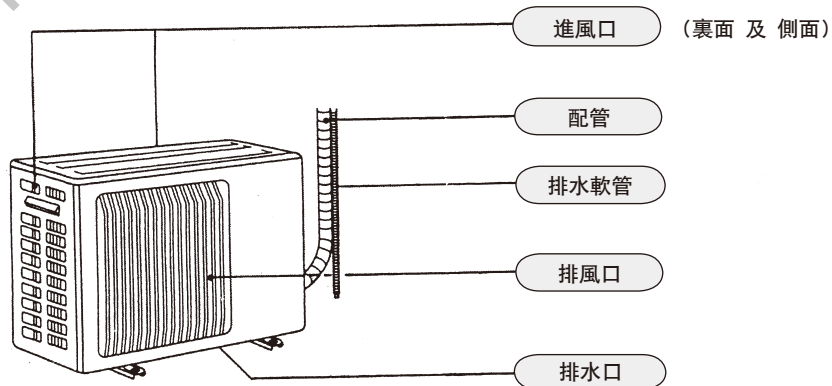



# 各部件名稱

## 遙控器

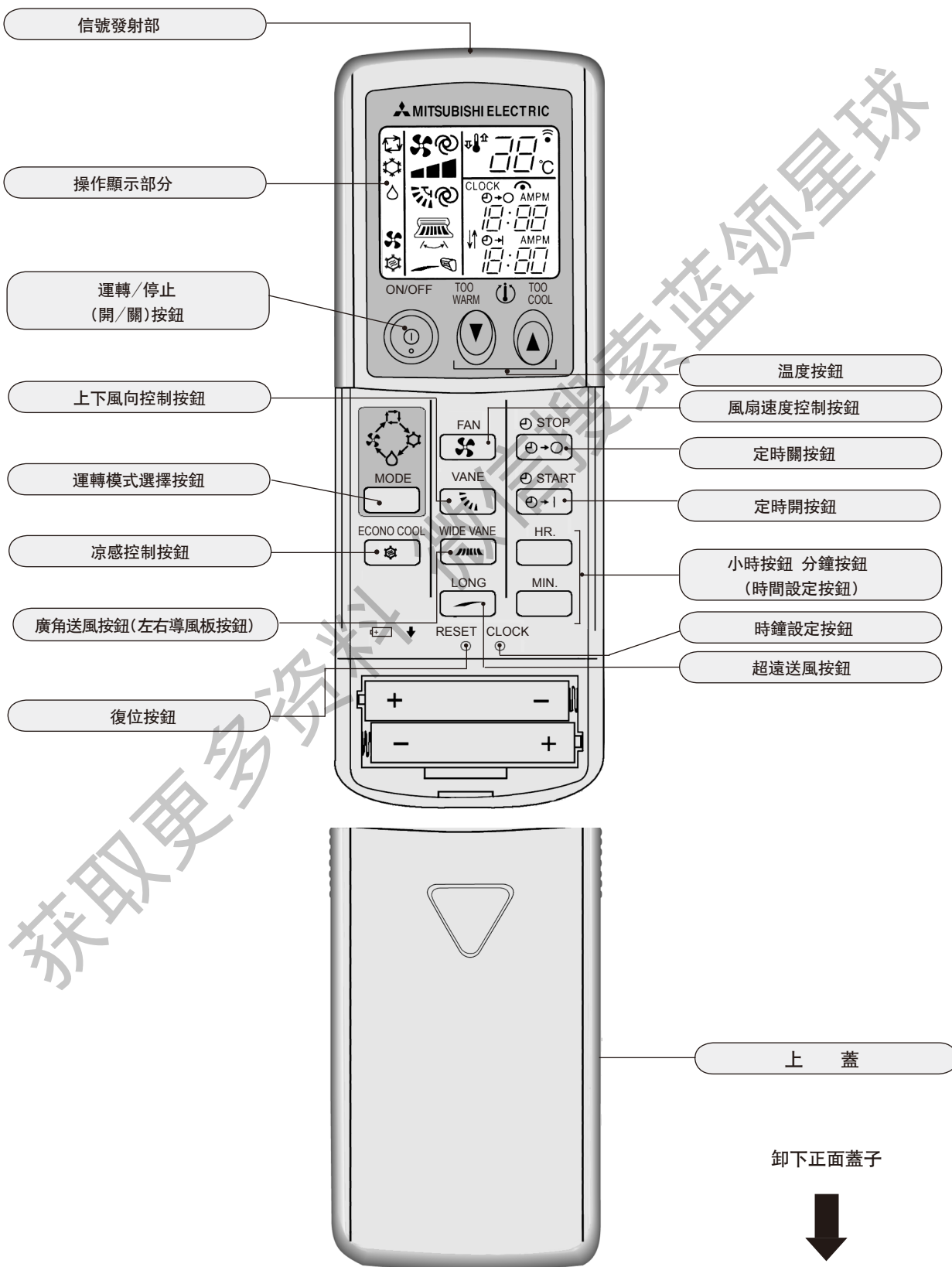



# 操作前的準備工作

## 自動重新啓動功能

該機型具有自動重新啓動功能，但在工廠出貨時，此功能設為關閉。如您需要使用自動重新啓動功能，請與技術服務中心聯系。

### 自動重新啓動功能就是...

當使用遙控器控制室內機組時，記憶體記憶運轉模式，設定溫度和風扇速度。如果運轉過程中發生斷電或關閉了主電源，當電源恢復後，“自動重新啓動功能”會自動啓動機器并以斷電前用遙控器設定的模式運轉。

## 室內機組

將撥動開關推到開的位置。

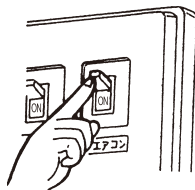

### 警告

須清除電源插頭上的灰塵，確實插頭穩固。  
如果附着有灰塵或插座不良時，將有發生火災、觸電的危險。

## 遙控器

**1** 移去前蓋，裝入電池，重新裝好前蓋板。

先插入電池的負極。檢查電池的極性是否正確。

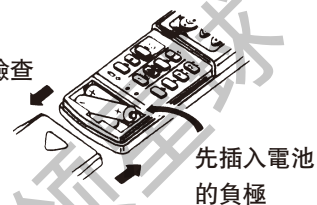

**2** 按下復位按鈕。

用尖細東西按下

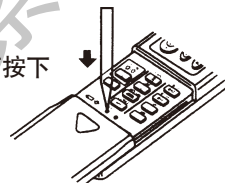

如果復位按鈕未按下，遙控器不能正常使用

**3** 按下 時鐘 設定按鈕

用尖細東西按下

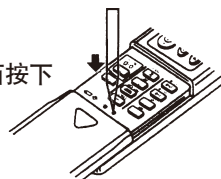

**4** 按下小時與分鐘按鈕（時間設定按鈕）設置當前時間

- 每按一下 小時 按鈕，時間增加1小時。
- 每按一下 分鐘 按鈕，時間增加1分鐘。

**5** 再次按下 時鐘 按鈕并合上前蓋板



# 操作前的準備工作

## 遙控器使用注意事項

- 信號可到達範圍是對着室內機組正面的直綫距離6米以內。
- 按下按鈕時，室內機組將發出“嗶!”或“嗶嗶!”的接收了信號的聲音。  
如果沒此響聲時，請再作一次按鈕操作。
- 遙控器必須小心使用。  
如果讓它掉落地上，隨便投擲，或浸了水則可能出現不能發送信號的情況。
- 不要用力擰扭遙控器，或用較強外力故意或作故意壓迫遙控器，這樣做可能會損壞其內部部件。

## 電池

### 更換乾電池的標準

信號機組難以接受到信號，或顯示變淡時，便請更換兩個7號鹼性電池(LR03)。

- 電池必須2個同時更換，且須屬同種電池。
- 不要使用充電式電池。
- 為防止電池漏液引起故障，在準備長期不使用時，應把電池都卸除。
- 鹼性電池壽命大約一年。  
但要考慮乾電池底面的建議期限(年月)，如果接近期限，則必須盡早更換電池。
- 遙控器信號機組難以接受到，並且顯示變淡時，按下按鈕液晶顯示屏全亮，空調器作體感自動運轉。

## 遙控器的安放

### 安放位置

- 便于操作使用及當眼的地方。
- 幼兒的手摸不到的地方。

## 注意

在有熒光燈的房間由于使用周期接通的高壓脈衝穩壓器或斷續振蕩器，有時室內機組接收不到來自遙控器的信號。

## 遙控器不能使用時(應急運轉)

當遙控器的乾電池用完了電，或遙控器故障時，可利用本機上的應急運轉開關應急控制運轉。

- 1** 按下應急運轉開關。  
每按下一次按鈕，即作應急冷氣→停止的順序變化。  
應急運轉開關一旦按下，機組將試運轉30分鐘後切换到應急方式。

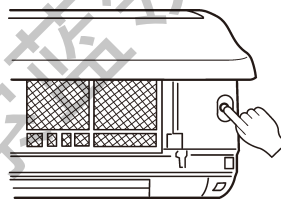

應急方式如下詳述。

溫控在測試運轉30分鐘內不起作用，而且機組處於連續運轉狀態。試運轉時風扇速度設置為高速并在30分鐘後切换到中速。

運轉模式	制冷
設置溫度	24°C
風扇速度	中
水平風葉	自動
垂直風葉	前

運轉模式將體現在室內機組的運轉指示燈上。

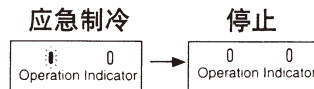

- 2** 要停止時，請按下應急運轉開關設定為停止。  
每按下一次按鈕，即作應急冷氣→停止的順序變化。



# “I FEEL...”(體感...)自動運轉

## 要選擇體感自動運轉時

在 “(I FEEL...(體感...))” 自動運轉模式下，一次操作就可自動使室內環境條件達到最佳狀態。

按下 按鈕。

顯示 (自動運轉)時，空調機即可自動地控制為最適當的溫度。

● 要停止時

請按下 按鈕。

開始運轉後大約經過15分鐘，  
如果你仍感到太熱時，

要降低溫度時，可按下 按鈕。  
按一次，大約下降1°C。

如果您仍感到太冷時，

要升高溫度時，可按下 按鈕。  
按一次，大約上升1°C。

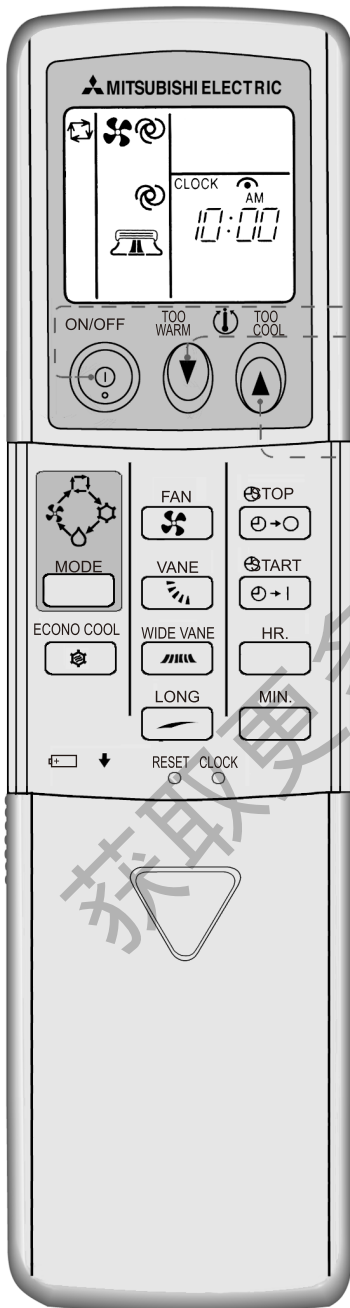

## 注意

不顯示自動運轉時，請按 按鈕以設定自動運轉模式。  
每按下一次，運轉模式即按照 (自動運轉) → (製冷) → (除濕) → (送風) 的順序的變化。

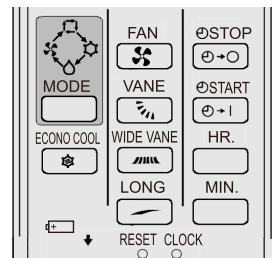



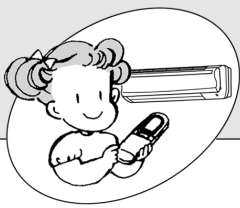

# “I FEEL...”(體感...)自動運轉

## 自動運轉的結構

運轉模式選擇（製冷、除濕、送風）

開始運轉時，將根據室溫自動地設定製冷或除濕運轉，但在停機後2小時以內再運轉時，則將與上次運轉進行同樣內容的運轉。一旦設定好運轉內容後，室溫雖有變化也不受影響。

如果不喜歡運轉內容，可按下  按鈕，再選擇適當的運轉內容。

體感自動運轉內容

開始運轉時的室溫	運轉模式	目標溫度的標準(初期狀態)
大約25℃以上	製冷	大約24℃
大約13℃~25℃	除濕	初始室溫減去2℃

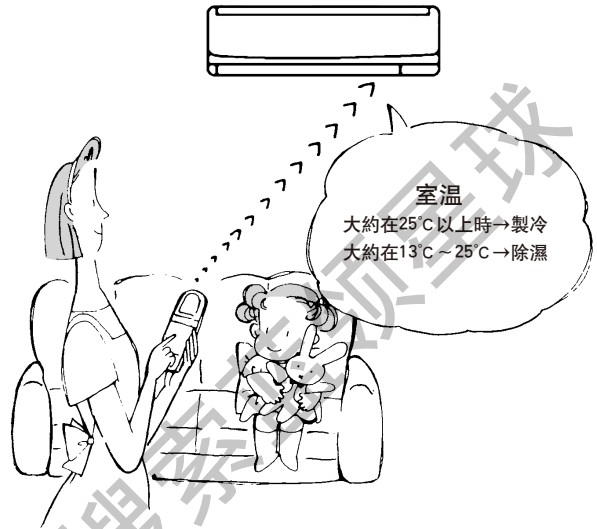

## 注意

製冷：室溫高於設定溫度2℃以上時，因空調正運轉以達到目標(設定)溫度，設定溫度可能不能改變。請耐心等待，直至室溫高於設定溫度2℃以內時再進行操作。

室內機組的顯示內容

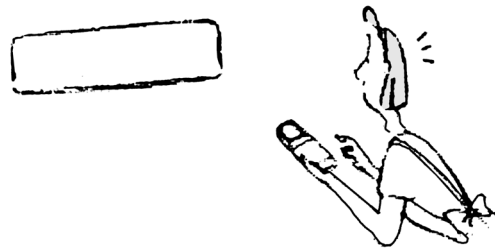



室內機組右邊的運轉指示燈指示運轉狀態。



● 點亮  
○ 不亮

運轉指示燈

指示燈	運轉狀態	目標溫度與室溫的差異
	空調正運轉以達到目標溫度。 請耐心等待。	2℃以上
	室溫接近目標溫度。	2℃以內

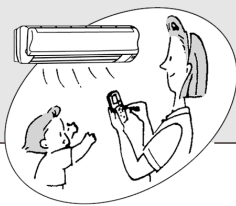

# 用戶自己選擇運轉模式時(製冷·除濕·送風)



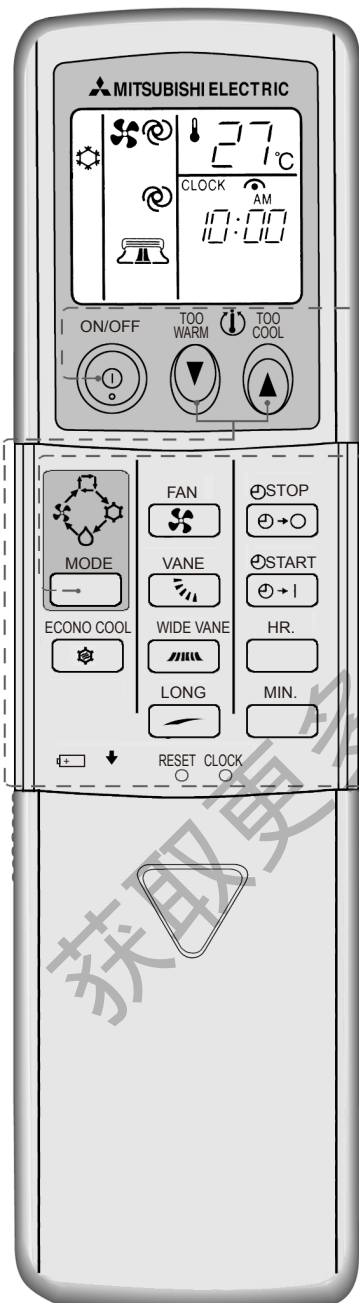

選擇運轉模式，  
可細微地調節溫度或風向



## 要選製冷·除濕·送風模式時

**1** 請按下 。

**2** 按下  選擇運轉模式。

每次按下按鈕，運轉模式即作  (自動運轉) →  (製冷) →  (除濕) →  (送風) 順序的變化。

● 要停止時

請按下 。

運轉模式設定以後，只要按下  按鈕，空調機即以設定模式進行運轉。

■ 要改變溫度時

■ 要降低溫度時，請按下  按鈕。

每次按下按鈕，溫度將下降 1°C。

■ 要升高溫度時，請按下  按鈕。

每次按下按鈕，溫度將上升 1°C。



## 除濕運轉時

■ 不能調節設定溫度。

■ 以稍低於室溫的溫度進行運轉。

## 注意

■ 環境溫度太高時，因為製冷運轉負載太大的關係，室內溫度可能無法達到設定的溫度。

■ 室內機組的顯示內容與“i FEEL”所顯示相同(請參看10頁)

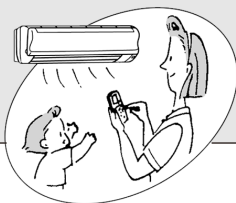

# 用戶自己選擇運轉模式時(製冷·除濕·送風)

## 使用空調須知

### 製冷 如何讓製冷運轉更有效率

① 關緊窗戶，放下窗簾，減少日照量。



② 在窗玻璃上貼市售的熱綫遮蔽用薄膜，也可減少進入室內的熱量。



③ 室外機組安裝在不易受太陽直射的地方。

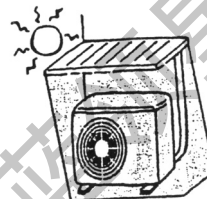

### 除濕

70%是人們感覺舒適的濕度分歧點。

人覺得悶熱，是因為空氣中的水蒸氣含量多，即濕度高的關係。濕度受溫度、風影響。一般認為人感到最舒適的濕度條件是夏季60%~75%，冬季55%~70%。

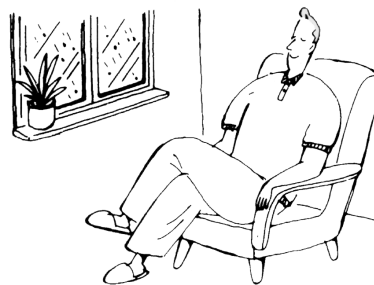



# 風速・風向的調節

選擇喜歡的风速與風向

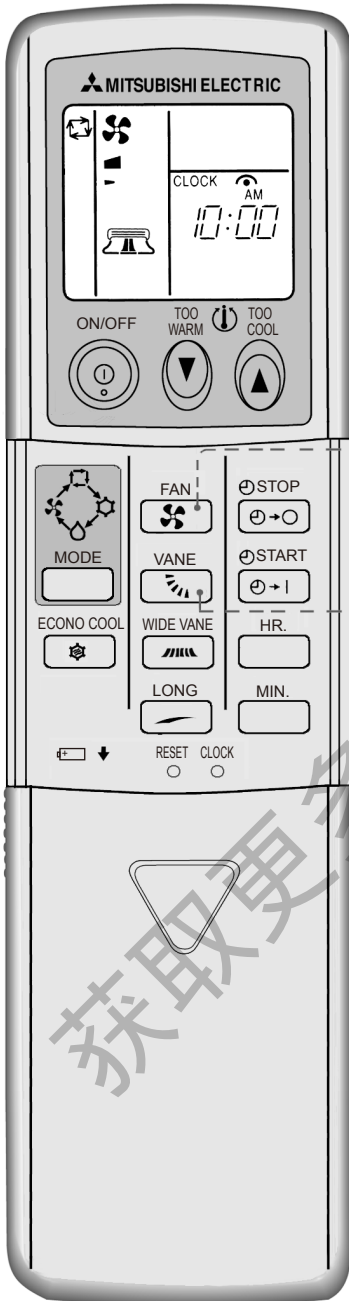

## 要改變風速・風向時

FAN

要改變風速時，請按下 按鈕。

每次按下按鈕，即按照 (弱) → (中) → (強) → (自動) 順序改變風速。

- 要使整個房間都降溫時，請用 (強) 模式 (製冷時)。
- 如果空调机的运转声音乾扰休息，就可选择 (低速) 档。

VANE

要改變上下的風向時，請按下按 鈕。

每次按下按鈕，即按照 (1) → (2) → (3) → (4) → (5) → (擺動) → (自動) 順序改變上下風向。

## 上下風向的推薦範圍

- 平常請用 (自動)
- (製冷) 或 (除濕) 請用 (1) (2) 的位置

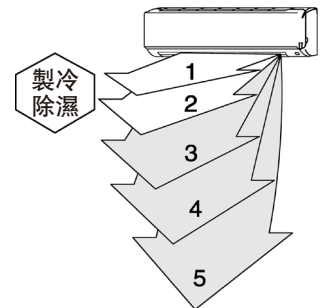

## 注意



- 除濕或製冷運轉，用 (4)， (5) 方向向下吹1個小時後，為防滴水，將自動地變成水平送風。
- 調節上下風向，請用遙控器操作控制。強制去轉動上下導風板，可能引起故障。
- 這裏的上下風向 (1) → (2) → (3) → (4) → (5) 僅為示意表示，并非表示導風板實際的角度。



# 風速 · 風向的調節

## 自動風向

VANE

當用  按鈕把風向設定為自動  時，將根據運轉模式自動地決定上下導風板的位置進行最有效率的運轉。

(1) 製冷 · 除濕時  
將以水平方向吹風。

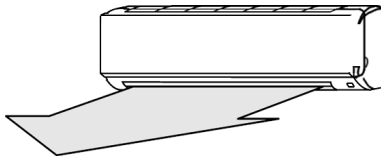

(2) 送風時  
將以向下方向吹風。

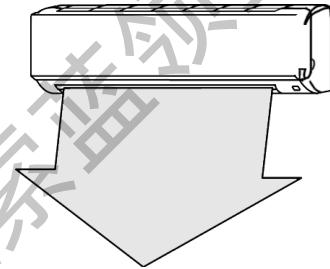

WIDE VANE

按  按鈕改變左右風向。

每按一次鍵，左右導風板的角度按以下順序變化。



左右送風範圍

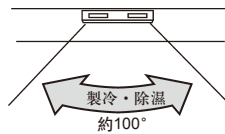

## 擺動送風

■ 使用擺動送風運轉，可使風到達房間每個角落。

## 注意

■ 使用遙控器調節左右風向時，如果手動調節左右導風板，可能會引起故障。



# 超遠送風

要選擇超遠送風時

運轉中，請進行如下操作

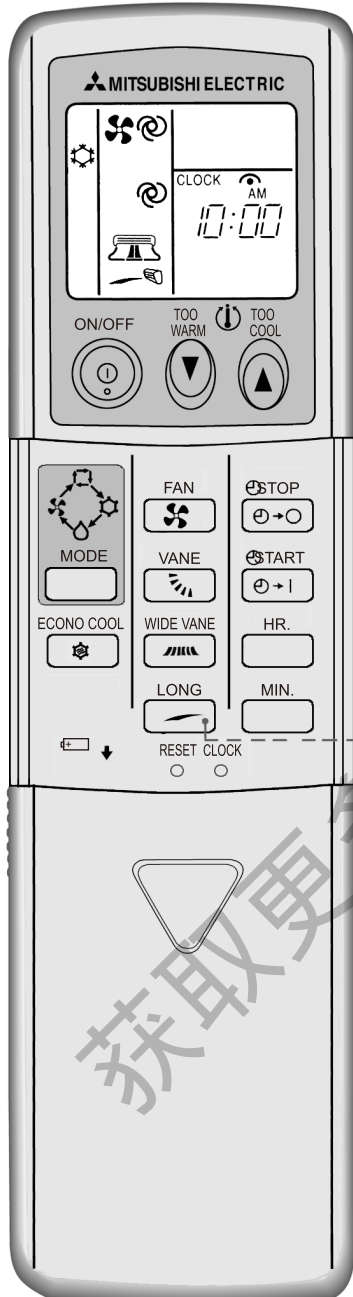

按下  按鈕。

風扇速度提高

風扇速度設置為自動時，風扇速度高於室溫與設定溫度所決定的速度。

此外，上下導風板轉向長距離位置。

超遠送風運轉機制

如下例所示，左右導風板設置為  前

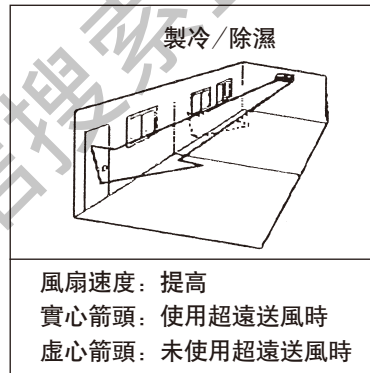

● 要取消時

請再按一次  按鈕。



## 注意

■ 按以下按鈕也會取消超遠送風方式。

● 按  按鈕

● 按  按鈕（僅當制冷時）

■ 即使使用超遠送風時，因空調安裝位置不當，氣流也可能達不到超遠。

此時，按  按鈕將風扇速度設置為高速檔，然後按  按鈕。

■  運轉模式選擇按鈕、 風速按鈕、 廣角送風按鈕、溫度按鈕與開/關定時器可繼續使用。





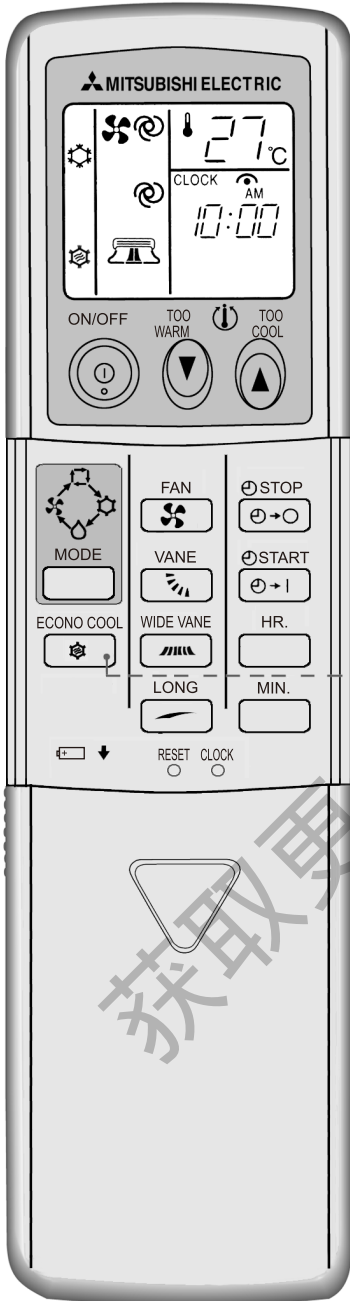

# 凉感運轉(健康·舒適·省電運轉)

要享受健康、舒適、省電的製冷運轉時，請使用此模式。



## 要選擇凉感控制模式時

### 在冷運轉中，請進行如下操作

- 按下  按鈕。  
選擇以凉感控制模式運轉的空調機，將根據室內機出風口溫度控制上下導風板作周期性自動擺動。另外，設定溫度也從製冷運轉時自動升高2°C。
- 要解除時  
■ 請再按一次  按鈕。

### 什麼叫凉感控制?

凉感控制將以往空調的室溫控制改變為體感控制。空調運轉開始後的前十分鐘，室內機大部分時間向下送風，對人的活動區域集中降溫。隨後向上送風，對整個房間進行降溫。同時根據室內機送風口的溫度，間歇性的向下送風，給人體以冷風刺激。送風口溫度低時，向下送風時間短；送風口溫度高時，向下送風時間長，這樣可以防止過冷，也防止了以往空調長時間向下對人體吹風造成的空調病。凉感控制的室溫變化雖與以往空調相同，但因人體降溫先於房間降溫，且有間隔性的凉風刺激，所以即使室溫比以往空調高2°C，也能得到同樣凉爽、舒適之感。(如以凉感控制模式運行時的室溫26°C，與以往空調24°C的凉感相同)省電效果達到20%。

### 注意

- 凉感控制模式僅在製冷運轉時可使用。
- 在凉感控制模式運轉中，按下  按鈕、 或變更運轉模式，凉感控制解除。
-  按鈕、 過暖按鈕、 過冷按鈕、定時開/關可繼續使用。



# 定時器設定(定時關・定時開)

## 定時器

可預設在就寢後或您回家時或起床時開・關空調器。

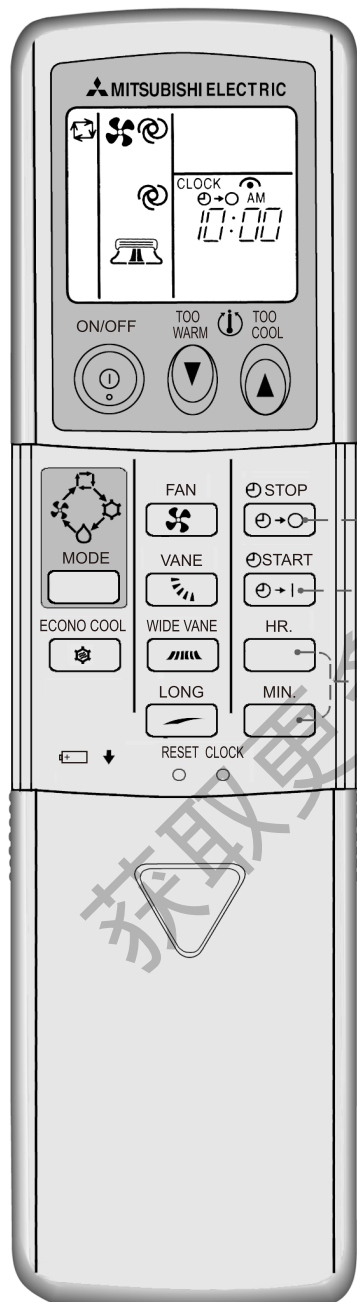

## 如何設置定時器開

**1** 運轉時按  按鈕。

每按一下按鈕，定時開方式在 開/關方式交替變化一次。

**2** 使用  與  按鈕設置定時器時間。

每按一下  按鈕，時間延長1小時，

每按一下  按鈕，時間延長10分鐘。

解除定時器：

按下  按鈕。

## 如何設置定時器關

**1** 運轉時按  按鈕。

每按一下按鈕，定時開方式在 開/關方式交替變化一次。

**2** 使用  與  按鈕設置定時器時間。

每按一下  按鈕，時間延長1小時，

每按一下  按鈕，時間延長10分鐘。

解除定時器：

按下  按鈕。

## 定時器運轉的編程

定時開與定時關可結合使用。先到的設定時間先運轉。（“↓↑”標記指示定時器的運轉順序）

### 注意

- 定時開、定時關能同時設定。
- 設定時間能以1小時或10分鐘為單位。
- 定時器設定中及設定後按  按鈕後，定時器設定取消，所有的運行停止。
- 設定時間最大為24小時。
- 如果未設定當前時間，定時器運轉可能不能使用。

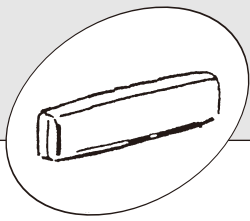

# 長期不使用時

## 長期不使用時

**1** 實施風扇運轉3~4小時，讓空調機內完全乾燥。

- 要進行風扇運轉時，請設定為製冷運行模式並選擇最高設定溫度。

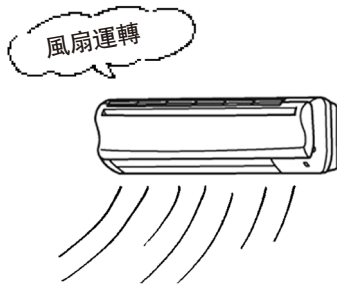

**2** 關掉電源開關。

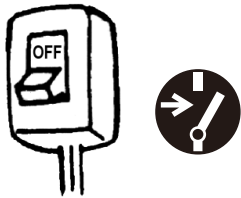

### 警告

長期不使用機器時，應拔下電源插頭。  
因為可能堆積灰塵而引起火災。

**3** 取出遙控器中的電池。

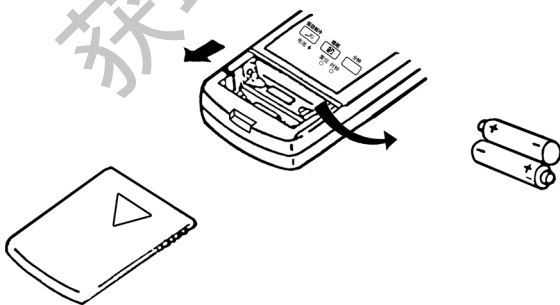

### 警告

為防止漏液，遙控器長期閑置時請取出電池。

## 要再開始使用時

**1** 清掃茶精清新網，並裝回本機。  
(清掃的方法，請參看20頁)

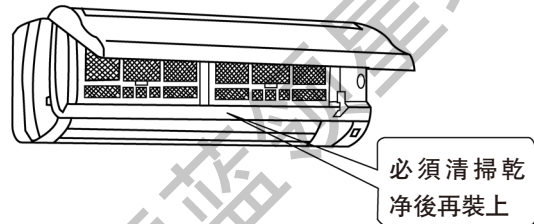

**2** 室內及室外機組的進風口、排風口，須確認是否被遮蔽了。

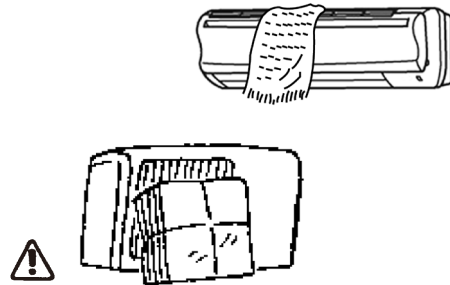

**3** 確認接地線是否牢固。

### 警告

要接地線。

- 地線不可接在煤氣管、自來水管、避雷針、電話線上面。
- 若無接地線或不按要求接地線，可能有觸電危險。



# 室內機組的清掃

## 清掃之前

■ 關掉電源開關。

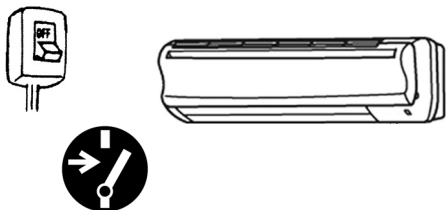

## 室內機組的清掃

■ 請用軟布乾擦

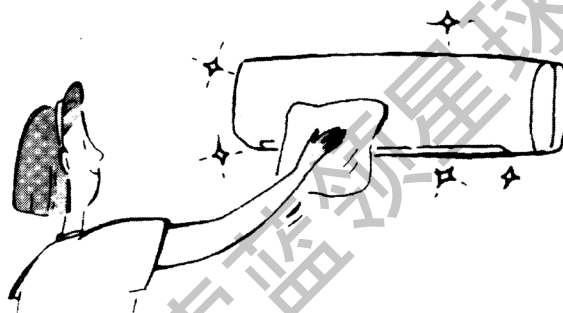

### ⚠ 警告

清掃時，必須停止運轉，拔下電源插頭并關掉電源開關。  
因為運轉中，高速旋轉中的風葉，可能造成人身傷害。

禁止使用汽油、苯、稀釋液、磨粉、洗滌劑、殺蟲劑等會損壞空調器的物品清掃機器。

### ⚠ 警告

## 打開前框不要超過水平位置防止掉落受損

■ 如果拉下前框的搭扣，前框可能掉落。

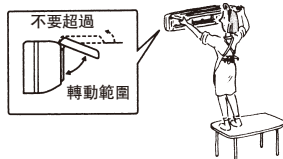

■ 如果前框掉落，如下所示安裝。

一手保持前框水平，另一手將搭扣依次插入室內機組頂部的左邊右邊和中間的凹槽并到位①，然後閉合前框②。

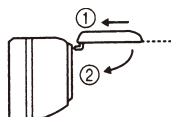

■ 清掃時不要立在不穩定的支撐上，以防跌倒受傷。



# 茶精清新網的清掃

清掃時，只可將前面板打開到如圖示位置，不要打開到水平位置。水平位置時，前面板將會脫落下來。

## 茶精清新網的清掃(兩星期一次為標準)

### 1 卸下茶精清新網。

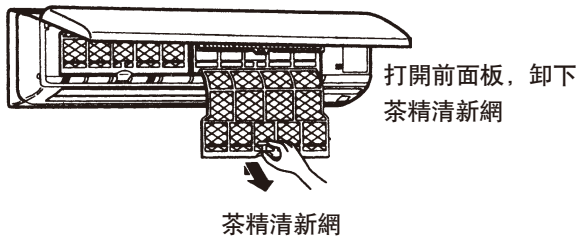

#### ⚠ 注意

拆卸茶精清新網時，請注意別碰到室內機組的金屬部分，因為有被刮傷的可能。

### 2 卸下的茶精清新網，可用吸塵器清掃或用水洗滌乾淨。

- 如果茶精清新網太髒了，可用加入中性洗滌劑的溫水溶液洗刷。
- 禁止用熱水(大約50°C以上)清洗，以免變形。

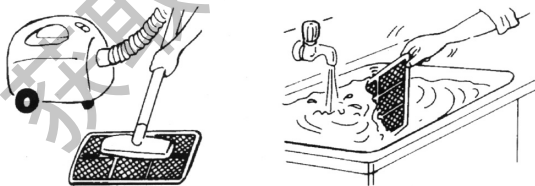

### 3 用水洗滌過後，放在陰涼處待乾才能使用。

- 茶精清新網，禁止利用直射陽光或用火烘乾。

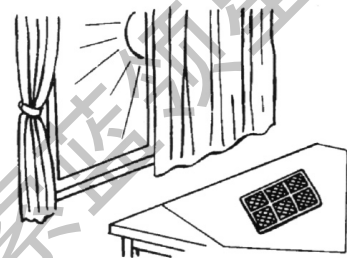

### 3 安裝茶精清新網。

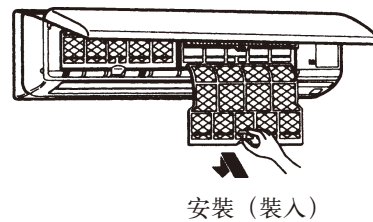

茶精清新網的作用：從綠茶中分解的茶精成分，能清除香烟、汗水等的臭味，更能抑制細菌的產生，成長，繁殖。  
(依照日本紡織檢查協會，纖維產品的定量抗菌性試驗方法。)



# 在請維修人員之前，請再次檢查以下項目

完全不運轉？

↓  
進行下一步檢查！

- 1** 電源開關或保險絲是否切斷了。

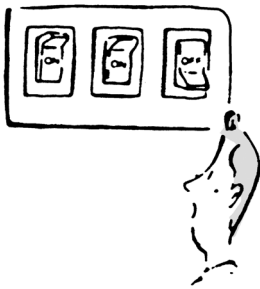

- 2** 是否設定着「定時開狀態」。



製冷運轉無法製冷？

↓  
進行下一步檢查！

- 1** 溫度調節是否適當。



- 2** 空氣過濾網是否髒了。

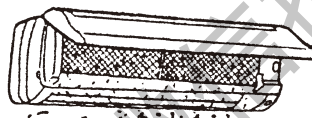

- 3** 室外機組的排風口、吸氣口是否被遮蔽了。

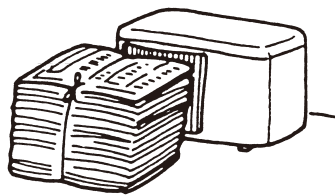

遙控器不顯示，遙控器不靠近機器便不起作用。

- 1** 乾電池是否沒有電了。

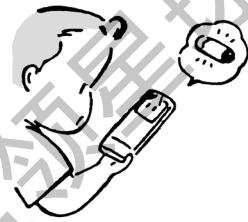

- 2** 乾電池的(+)、(-)電極是否裝反了。

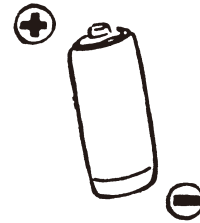

發生停電時？ ⇨ 進行下一步檢查！

空調機處於停止狀態。通電後，請再按運轉/停止按鈕。

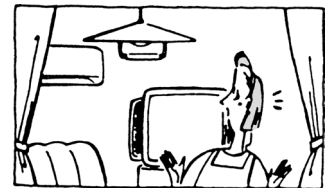

檢查上述各項目後，如果問題仍不能解決時，請立即停止使用，并與機器的出售店或技術服務中心進行聯繫。

在要求維修之前，請注意下列情況。

■ 在使用電子式熒光燈的房間裏，有可能不能接收遙控信號。

■ 在無線電廣播電波弱的地方，可能在空調機運轉的時候，收聽短波廣播會有噪聲。

■ 打雷時，請停止運轉并拔下電源插頭或關掉電源開關器。否則，可能有損害空調電氣部件的危險。





# 當您認為「發生故障？」時

## 是否出了故障？

雖然，重新開機運轉，可是室外機大約3分鐘內并不啓動。

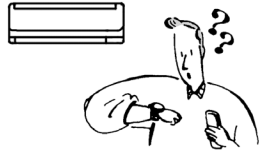

剛開始運轉時，不會馬上就吹風

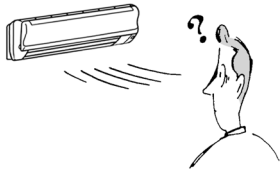

制熱運轉中，有時要停止運轉約10分鐘。

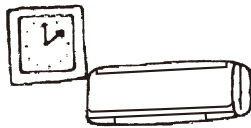

發出“嘩噓！”的聲音。

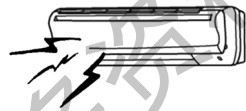

房間裏有臭味兒。

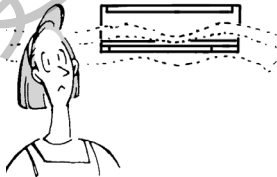

除濕(△)運轉中，風扇停止了。

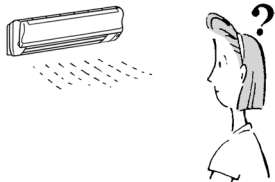

## 答案(不是異常)

■ 這是根據微型電腦的指示以保護空調機的現象，請放心等待。

■ 正在準備能吹出足夠溫暖的風，就這樣請等候。

■ 正在溶化室外機組上的結霜。(除霜運轉)最長10分鐘就完了，就這樣請等候。  
(戶外氣溫低而濕度又高時，便會結霜。)

■ 因溫度變化，前面板發生膨脹、收縮引起的摩擦聲音。

■ 這是空調機吸取牆壁、地毯、家具、衣服所含霉味而吹出到空氣中的現象。

■ 附在室內機組熱交換器上的水分再蒸發時，濕度便會上升。爲了抑制此現象，當室溫已充分下降時，室內機組的送風運轉便會自行停下來。



# 當您認為「發生故障？」時

是否出了故障？

答 案(不是异常)

可從室內機組聽到“咯  
嗒咯嗒”聲音。



■ 這是風扇或壓縮機切換開關的聲音。

室內機發出“布噓！”聲。

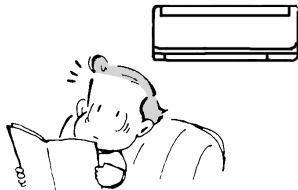

■ 這是空調機啓動或停止冷媒流動的聲音。

室外機組有漏水現象。

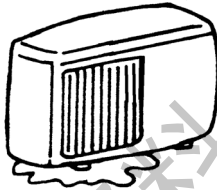

■ 製冷運轉中，管道或管道接頭部分將因冷却而引起水份冷凝。

房間不能充分製冷。

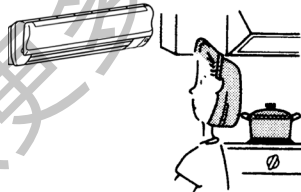

■ 排風扇或液化爐具使用時，製冷負荷加重，導致製冷效果不足。

■ 室外氣溫太高時，製冷效果不足。

左右導風板的  
搖擺送風暫停，15秒後重  
新啓動。

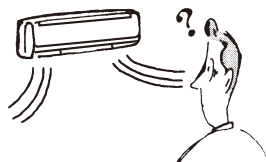

■ 這是使左右導風板的搖擺送風正常運轉所致。



# 安裝 · 移機 · 檢查

## 安裝場所

禁止安裝在如下的場所。

- 有可能洩漏可燃性氣體的地方。

### ⚠ 注意

- 禁止安裝在有可能洩漏可燃性氣體的地方。因為萬一洩漏的氣體聚集在機組周圍，將有引起爆炸的可能。
- 在電波信號較弱的地方，使用無線接受設備（電視機/收音機等）如發生信號明顯受干擾時，建議另購信號放大器，以提高接受質量。

- 有很多機油的地方。
- 海邊等鹽份多的地方。
- 溫泉等會產生硫化氫氣體的地方。
- 飛散油滴，聚集油煙的地方。
- 周圍有高頻機器或無線電設備/無線電或手機。

## 電氣施工

- 電源請一定使用空調機專用的綫路。
- 電源開關須採用規定的容量。

### ⚠ 警告

- 用戶不可自己安裝。安裝不妥，將可能發生火災、觸電、機組掉落傷人，或漏水等問題。
- 禁止在電源綫中途引綫，或用延長電綫，或使用多孔插座。接電不妥，可能因接觸不良、絕緣不良或超過電流容量而發生火災或觸電等事故。請洽詢購買機器的出售店或專業者為您服務。

### ⚠ 警告

- 空調插座應連接有專門接地綫，地綫切勿接到煤氣管、自來水管、避雷針導綫、電話接地綫上。
- 如果沒有接地綫或地綫沒有連接好，可能引起觸電事故。
- 在使用前請務必確認是否有接地綫或接地綫是否按要求的連接。
- 安裝空調機時有些地方（潮濕的地方），須裝漏電保護器。不裝漏電保護器，可能有觸電的危險。

電視機或收音機等無線接受設備需距離室外機3米以上，如這樣還有明顯信號干擾時，可再加長相互間距離，以提高接受質量。

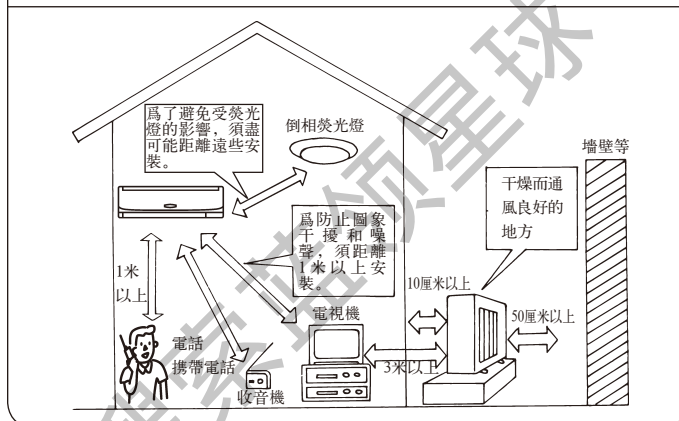

## 檢查維修

- 空調機用過幾年之後，因內部骯髒，性能將減低。
- 因使用狀況而可能發生臭味，或因堆積塵垢而造成冷凝水的排水不良。
- 與普通的檢查維修不同，最好請專門技術人員為您服務。請與本空調器的出售店或技術服務中心聯繫。

## 運轉噪聲問題也須考慮

- 室外機組的排風口附近不可堆置東西。因為將會減低機器效能也可能增大運轉噪聲。
- 運轉作用中，如果發生異常聲音，即請與本空調器的出售店或技術服務中心聯繫。

## 要移機時

- 因增改建房間，遷居而須拆卸空調機及再安裝時，必須找專門技術人員為您服務。

### ⚠ 警告

用戶請不要自己修理或移設空調機。如果處理不當，便有發生火災、觸電、機組掉落傷人、漏水等的危險。請與本空調機的出售店或技術服務中心聯繫。

如果電源軟綫損壞，必須使用專用軟綫或從製造廠或維修部門買到的專用組件來更換。

此外，如果還有不明白的地方，即請找機器的出售店聯繫。

# 技術性能表

制品名	MSD-LD23VD-H1
防觸電保護	I類
電源	220V~50Hz
製冷量(kW)	6.20
製冷輸入功率(kW)	2.15
製冷輸入電流(A)	10.2
循環風量(m <sup>3</sup> /h)	900
冷媒充注量(kg)	1.9
噪聲(室內機)(dB(A))(高速檔/低速檔)	46/38
噪聲(室外機)(dB(A))	50
室內淨重(kg)	16
室外淨重(kg)	52
室內尺寸高×寬×深(mm)	325×1100×261
室外尺寸高×寬×深(mm)	655×860×330
標準配管長(m)	5
排氣側允許工作過壓(MPa)	2.74
吸氣側允許工作過壓(MPa)	1.01
熱交換器的最大工作壓力(MPa)	3.3
儲罐允許工作壓力(MPa)	1.31

注：❶ 本產品適用環境溫度範圍：

		室內	室外
製冷	上限	32°C 乾球	43°C 乾球
		23°C 濕球	—
	下限	21°C 乾球	21°C 乾球
		15°C 濕球	—

❷ 噪音值是表示出廠前全消音試驗室環境下測得數據。

❸ 測試標準：GB/T7725 GB4706.32-2004



# SAFETY PRECAUTIONS

- Be sure to read these safety precautions before use.
- Since these cautionary items shown here are important for safety, be sure to observe them. Marks and their meanings are as shown below.

Meanings of symbols used in this manual are as shown below.

	Be sure not to do.
	Be sure to follow the instruction.
	Be sure to apply grounding.
	Be sure to disconnect the power plug from the power outlet.
	Never step on the indoor/outdoor unit and do not put anything on them.
	Danger of electric shock, be careful.
	Never insert your finger or stick etc.

- After reading this manual, keep it together with the installation manual in handy place for easy reference.

Do not use the air conditioner in an environment where the volatile, corrosive or flammable chemical is in use.

- When the volatile, corrosive, or flammable chemical (e.g. dimethylbenzene, banana oil, carbinol etc.) is in use, be sure not to use the air conditioner.
- When the paint is wet, be sure to open the window to keep ventilation. To use the air conditioner after the dilution gas has been eliminated completely.
- Otherwise the unit may be corroded, or deformed, even it may cause a fire.



## ⚠ WARNING

Do not charge up or decompose the batteries and don't put off the batteries to fire.

- It may cause a liquid leakage, a fire or an explosion.



If the liquid lake from batteries, and dirty your skin or clothes. Please wash by water right away.

- If the liquid lake from batteries and dirty your skin or clothes. Please wash with water right away and go to hospital.

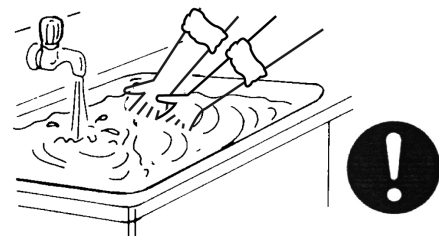

Replace two batteries with new batteries of the same type.





# SAFETY PRECAUTIONS

## ⚠ WARNING

Do not turn on/off the breaker during operation.

- This may cause a fire due to sparks, etc.
- Before turn off the breaker, be sure the unit is turn off by remote controller.

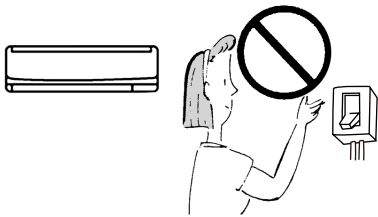

Do not clean the air conditioner with water.

- Water may enter the unit and degrade the insulation. It may cause an electric shock.

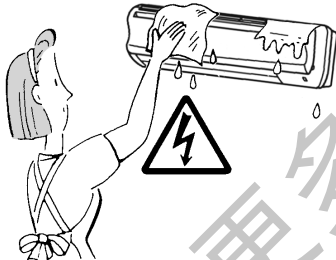

When an abnormality (smell of burning, etc) occurs, stop the air conditioner, and turn off the breaker.

- If the unit continues to be operated in an abnormal condition, it may cause a fire, trouble, etc. In this case, consult your dealer.

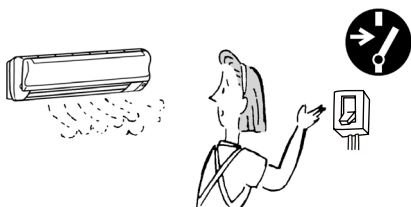

Do not insert your finger or stick, etc. into the air inlet/air outlet.

- Since the fan rotates at high speed, this may cause an injury.
- Children must be prohibited from playing with the unit.



Repair or relocation should not be done by the customer.

- If this is done incorrectly, it may cause a fire, electric shock, injury by dropping of the unit, water leakage, etc. Consult your dealer or service center.



The customer should not install this unit.

- If this is done incorrectly, it may cause a fire, electric shock, injury by dropping of the unit, water leakage, etc. Consult your dealer or service center.

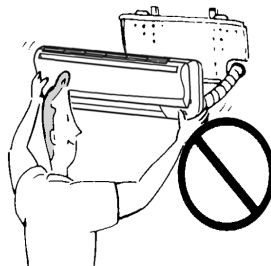

When the air filter is to be removed, do not touch the metal parts of indoor unit.

- It may cause an injury.



When the unit is to be cleaned, switch off, and turn off the breaker.

- Since the fan rotates at high speed during operation, it may cause an injury.

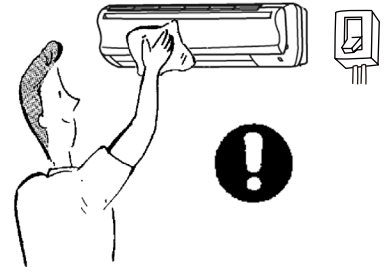

Do not operate switches with wet hands.

- It may cause an electric shock.

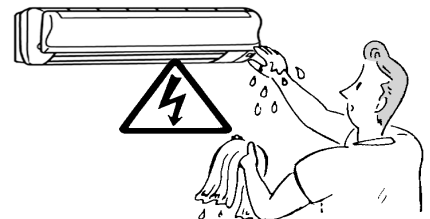



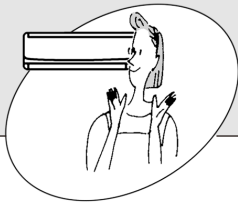

# SAFETY PRECAUTIONS

## ⚠ WARNING

Do not expose the skin to cool air directly for long time.

- This could damage your health.

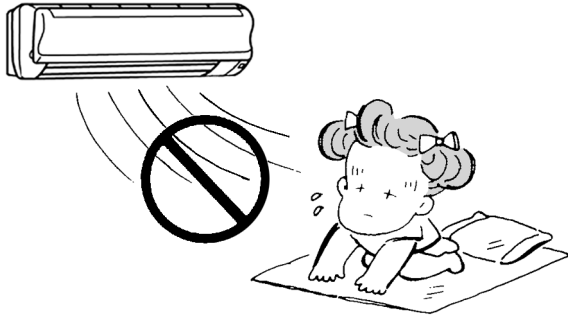

Do not step onto an unstable bench when attaching/detaching the panel.

- It may cause an injury, etc. by falling down.



Do not apply an insecticide or flammable spray.

- It may cause a fire or deformation of the cabinet.

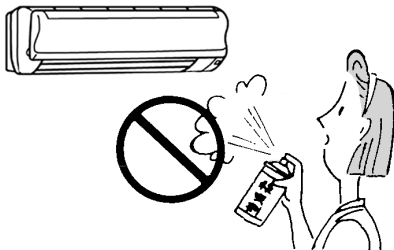

Ventilate well when used together with a stove, etc.

- An oxygen shortage may occur.

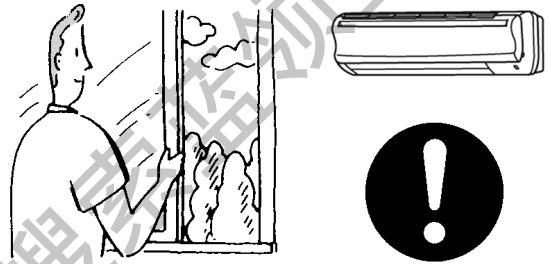

Do not put a stove, etc. where is exposed to direct air flow.

- It may cause imperfect combustion.

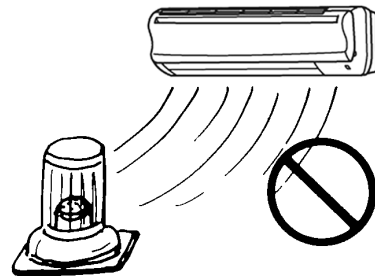



# SAFETY PRECAUTIONS

## ⚠ WARNING

When the unit is not going to be used for a long time, turn off the breaker.

- If not, dirt may collect and cause a fire.



Do not step on the indoor/outdoor unit and do not put anything on it.

- It may cause an injury through dropping or falling down.

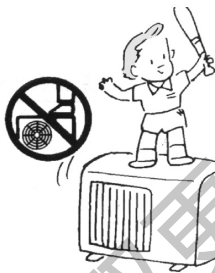

Do not leave on installation stand which is damaged.

- The unit may drop or fall down and cause an injury.

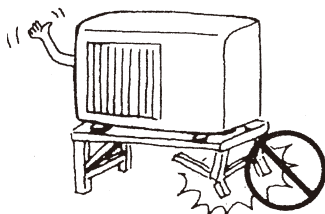

- Consult your dealer or service center for installing the air conditioner.

Apply grounding.

- Air conditioner socket must apply grounding by a special grounding wire. Do not connect the grounding wire to a gas pipe, water pipe, lightning rod or grounding wire of a telephone.
- If a grounding wire is absent or incorrect, it may cause an electric shock.
- Be sure whether there is a grounding wire and whether it is connected correctly.



Install an earth leakage breaker depending on the place where the air conditioner is to be installed (humid place, etc..)

- If the earth leakage breaker is not installed, it may cause an electric shock.



Do not install the unit where flammable or corrosive gas could leak.

- If gas leaks or collects around the unit, it may cause an explosion, or the unit may be damaged.



Drain water should be fully drained.

- If the drainage route is incomplete, water may drop from the unit, it may wet and spoil furniture.



## ⚠ CAUTION

Do not operate for a long time in high humidity, e.g. leaving a door or window open.

- In the cooling mode, if it is operated in a room with high humidity (80% r.h. or more) for a long time, water condensed in the air conditioner may drop and may wet and spoil furniture, etc.

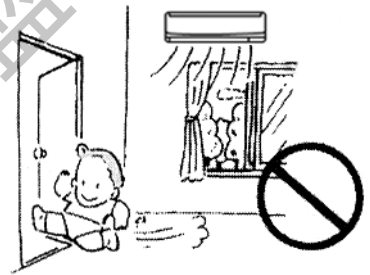

Do not use for special purposes.

- Do not use this air conditioner to preserve precision devices, food, animals, plants and art objects. It may cause deterioration of quality, etc.

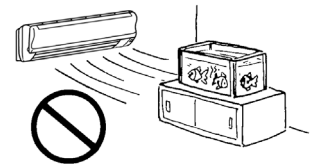

Do not put a pet or house plant where will be exposed to direct air flow.

- This could injure the pet or plant.

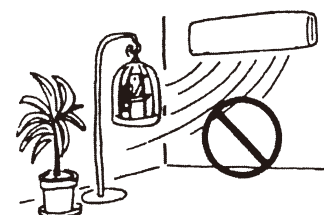



# NAME OF EACH PART

## Indoor unit

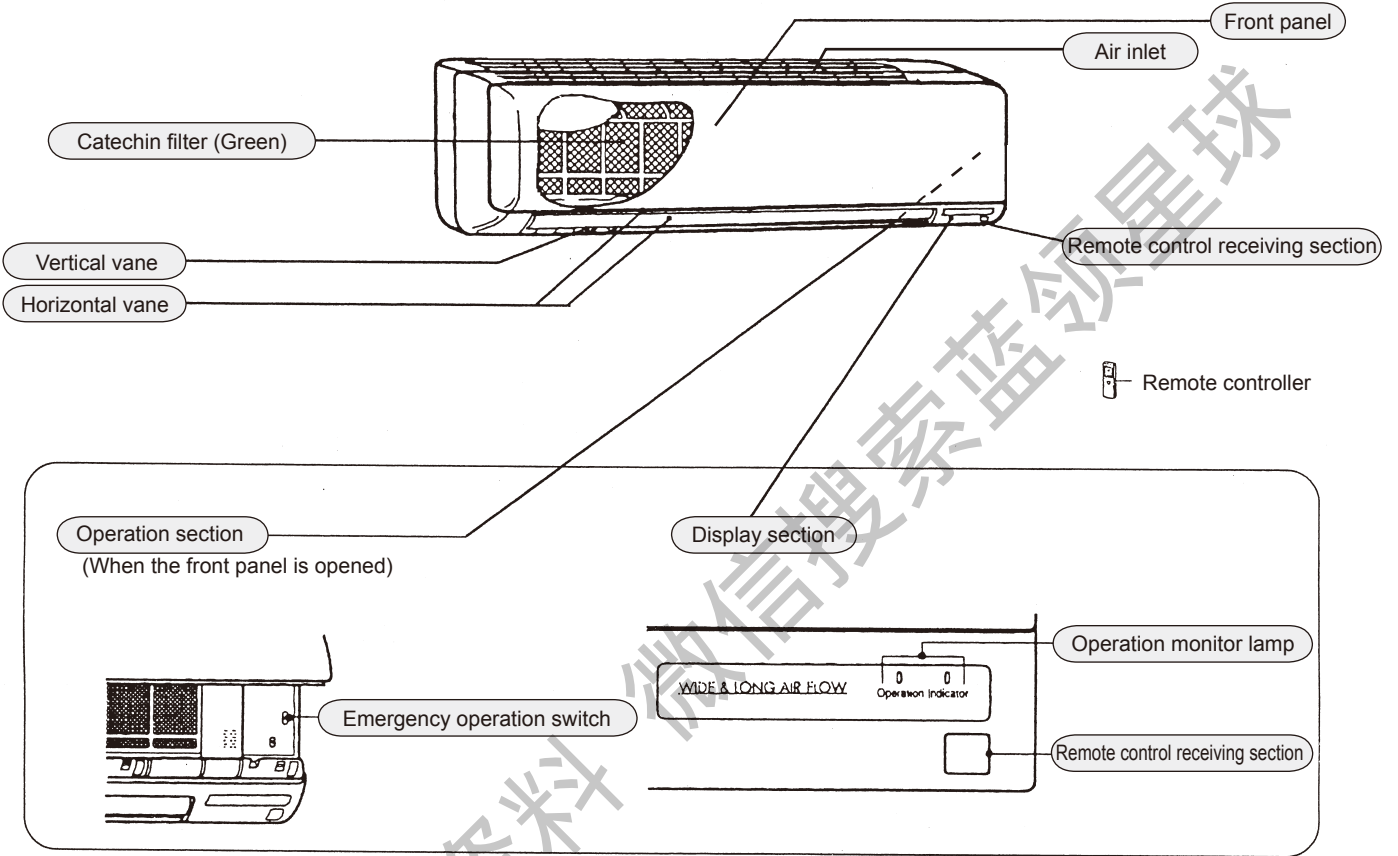

## Outdoor unit

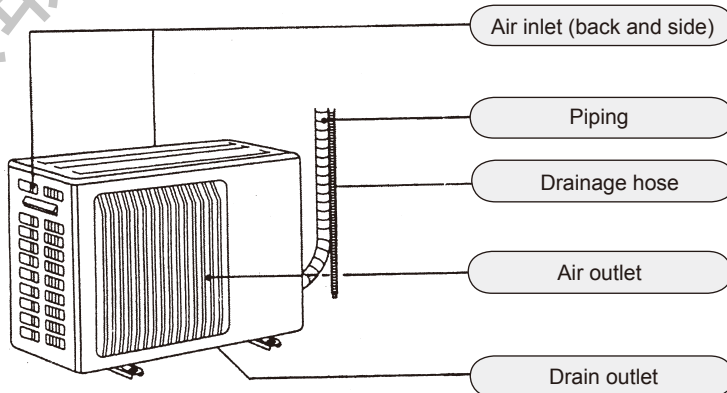



# NAME OF EACH PART

Remote controller

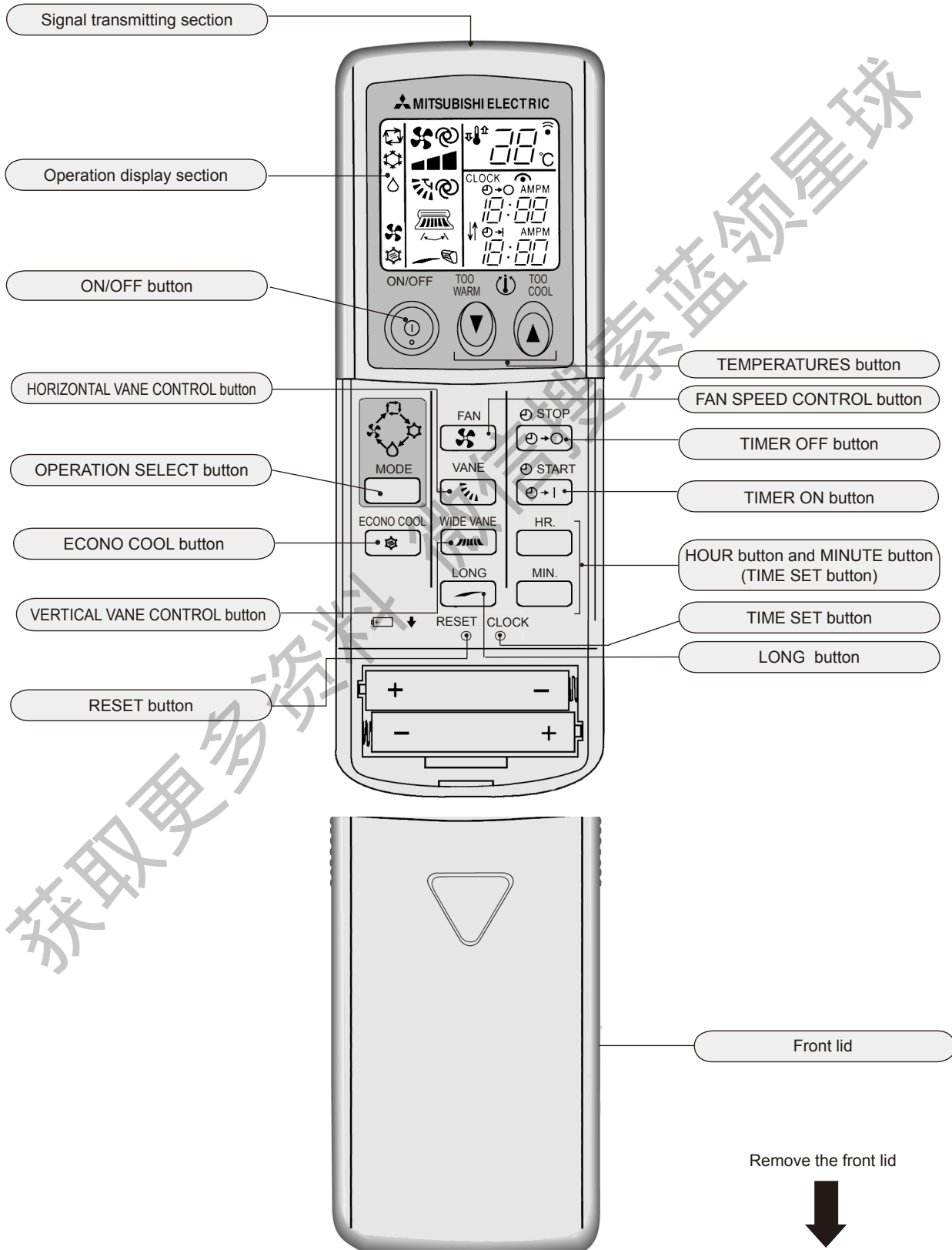



# PREPARATION BEFORE OPERATION

## AUTO RESTART FUNCTION

This unit has AUTO RESTART FUNCTION, but when it is leaving factory, this function is set off. If you need this AUTO RESTART FUNCTION, please contact with the Service Center. Because the configuration of the unit should be changed.

### AUTO RESTART FUNCTION is .....

The operation mode, set temperature and fan speed will be memorized when using the remote controller to control the indoor unit. If a power failure occurs during operation, the AUTO RESTART FUNCTION may start the unit automatically and run it at the mode set by the remote controller before the power is off.

## INDOOR UNIT

Turn the breaker on.

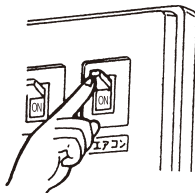

### ! WARNING

Remove dirt from the power plug and insert it securely. If dirt adheres to the plug or insertion is incomplete, it may cause a fire or electric shock.

## REMOTE CONTROLLER

- 1 Remove the front lid and insert batteries, and then reattach the front lid.

Do not confuse(+) and (-).

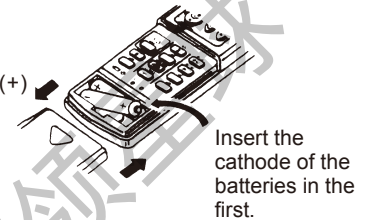

- 2 Press the RESET button.

Press it using a thin stick.

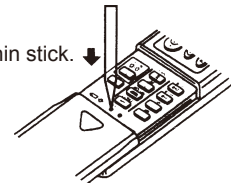

- If the RESET button is not pressed, the remote controller may not operate correctly.

- 3 Press the TIME SET button

Press it using a thin stick.

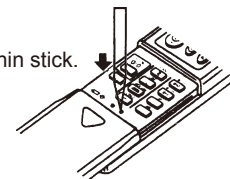

- 4 Press the HOUR button and MINUTE button (TIME SET button) to set the current time.

- Each time the HOUR button is pressed, the time increases one hour.  
Each time the MINUTE button is pressed, the time increases one minute.

- 5 Press the TIME SET button again and close the front lid.



# PREPARATION BEFORE OPERATION

## Notes for using the remote controller

- The range that the signal can reach is about 6m when pointed at the front of the indoor unit.
- When the button is pressed, one or two beeps will be heard from the indoor unit. If no sound is heard, operate again.
- Use the remote controller carefully. If it is dropped, thrown or gets wet, it may not operate.
- Do not wring or press the remote controller, it may cause the components inside the remote controller damage.

## Batteries

### Reference for replacing batteries

When the signal does not operate the indoor unit, or the display becomes dim, replace the batteries with new alkaline batteries (LR03)

- Replace 2 batteries with new batteries of the same type.
- Do not use rechargeable batteries.
- To prevent from liquid leakage, take out all batteries when the remote controller is not going to be used for a long time.
- The service life of an alkaline battery is about 1 year.
- However, since the recommended usable time limit is indicated (month / year) on the bottom of the battery, a battery the time limit of which is approaching may become exhaust sooner.

When the signal does not operate the indoor unit and the display becomes dim, press the button and the OPERATION DISPLAY SECTION display all patterns, at the same time the air conditioner runs as "I FEEL..." AUTO-OPERATION mode.

## Laying the remote controller

### Laying places

- The places where it is easy to operate and easily visible.
- The places where children can not touch.

### NOTE

In rooms where inverter type fluorescent lamps are used, the signal from the wireless remote controller not be received.

## WHEN THE REMOTE CONTROLLER CANNOT BE USED (Emergency operation)

When the batteries of the remote controller run out or remote controller malfunctions, Emergency operation can be done using the Emergency operation switch.

### 1 Press the Emergency operation switch.

Each time the switch is pressed, the unit alternates between the Emergency COOL mode and STOP mode. However, when the EMERGENCY OPERATION switch is once pressed, the unit will operate in test run for 30 minutes and then the operation mode shifts to EMERGENCY MODE.

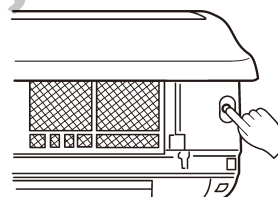

Details of operation are as shown below. However, the temperature control does not work for about 30 minutes at first and the unit is set to the continuous operation mode with the fan speed set to "Medium".

Details of operation	COOI
Set temperature	24°C
Fan speed	Medium
Horizontal vane	Auto
Vertical Vane	Front

## Emergency operation



### 2 To stop the Emergency operation, press the Emergency operation switch.

Each time the switch is pressed, the unit alternates between the Emergency COOL mode and STOP mode.

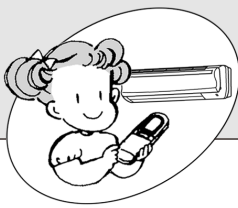

# "I FEEL..." AUTO-OPERATION

With the "I FEEL..." auto-operation mode, the optimum room condition can be set automatically by one-touch operation.

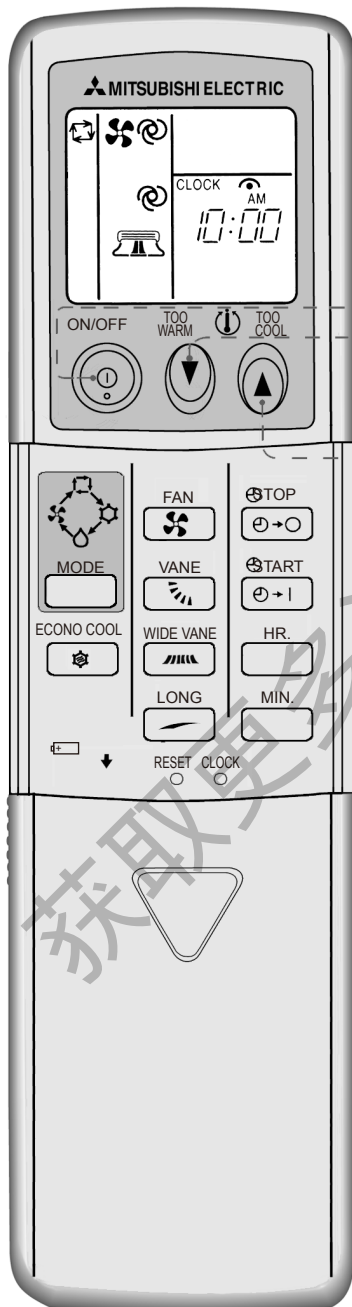

## TO SELECT "I FEEL..." AUTO-OPERATION

Press the  button.

When the "I FEEL..." is displayed, the air conditioner is automatically controlled at the optimum temperature.

To stop operation

Press the  button.

When about 15 min. passes after operation start. If you feel slightly warm,

Press the  button to lower the temperature.  
One press lowers the temperature by about 1°C.

If you feel slightly cool,

Press the  button to raise the temperature.  
One press raises the temperature by about 1°C.

## NOTE

When auto-operation is not displayed, press the  button to set to the "I FEEL..." auto-operation mode.

Each time the button is pressed, the operation mode is changed in sequence, from "I FEEL...", COOL, DRY to FAN.

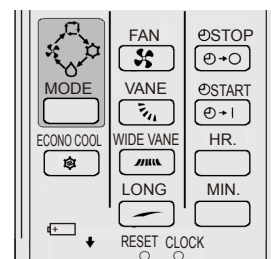





# "I FEEL..." AUTO-OPERATION

## DESCRIPTION OF "I FEEL..." MODE

### Details of operation

According to the room temperature when the operation starts, the operation mode is automatically selected between COOL and DRY. However, when operation is started again within 2 hours after the operation is stopped, the same operation mode before it is stopped is selected. The operation mode selected first is not changed even if the room temperature changes. If the operation mode does not match the room condition, select the requires operation mode by pressing the  button.

### Details of auto-operation

Room temperature when started	Operation mode	Target temperature (initial state)
About 25°C or higher	COOL	About 24°C
About 13°C ~ 25°C	DRY	—

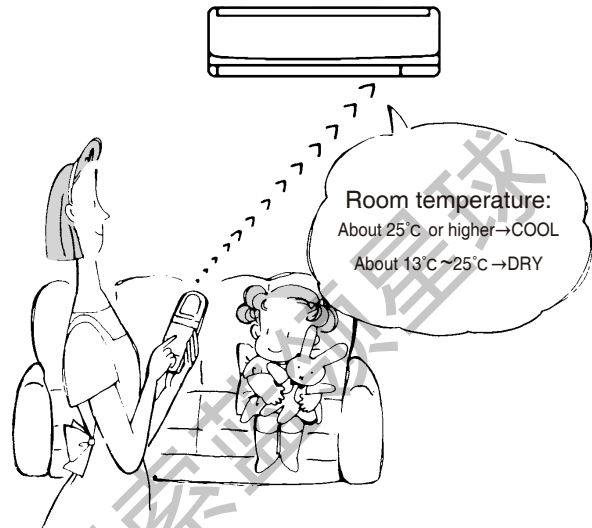

## NOTE

### Display details on the indoor unit



- When the room temperature is 2°C higher than set temperature, the set temperature may not be changed since the unit operates at high power. In this case, wait until the room temperature drops to within 2°C of set temperature.

### Display details on the indoor unit

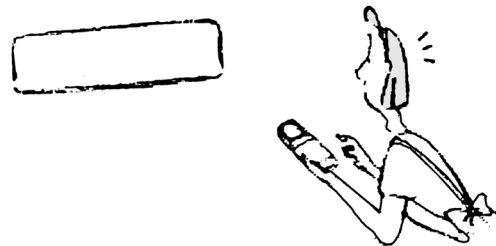
The operation indicator at the right side of the indoor unit indicates the operation state.



### Operation indicator lamp

Operation	Operation state	Difference between target temperature and room temperature
	This shows that the air conditioner is operating to reach the target temperature. Please wait until the target temperature is obtained.	About 2°C or more
	This shows that the room temperature is approaching the target temperature.	About 2°C or less

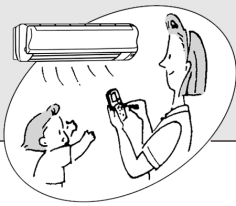

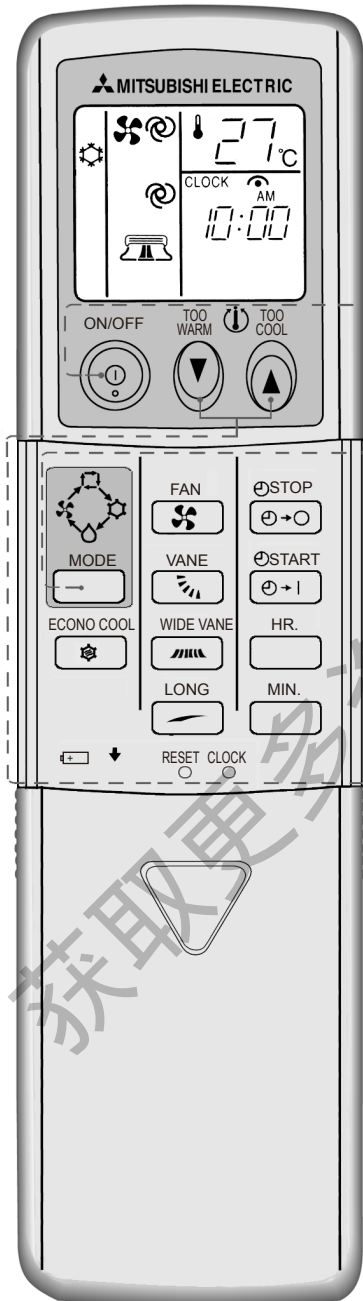

# MANUAL OPERATION (COOL, DRY, FAN)

With this operation mode, the temperature and airflow direction can be finely adjusted by selecting the operation mode.





To select the "COOL", "DRY" OR "FAN" MODE

**1** Press the  button.

**2** Select the operation mode by pressing the  button.  
Each time the button is pressed, the operation mode is changed in sequence, from "I FEEL...", "COOL", "DRY" to "FAN".

● To stop operation:

■ Press the  button.  
After the operation mode is set once, the operation starts in the mode set previously from the next time by simply pressing the  button.

■ When the set temperature is to be changed:

■ Press the  button to lower the temperature.

One press lowers the temperature by about 1°C.

■ Press the  button to raise the temperature.

One press raises the temperature by about 1°C.



## IN DRY OPERATION

- The temperature control (temperature setting) cannot be done.
- The room temperature is slightly lowered in this operation mode.

## NOTE

- When the ambient temperature is too high, the room temperature may not reach the set temperature since the unit operates to cool at high load.

■ The details displayed on the indoor unit are the same as those in the "I FEEL...". See page 31.

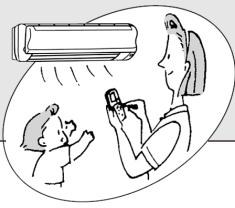

# MANUAL OPERATION (COOL, DRY, FAN)

## CONVENIENT INFORMATION

### COOL For effective cooling

① Close the windows and pull down blinds. Sunshine is reduced and cooling efficiency increases.



② Paste a heat shield film (generally available) on the window. Heat entering the room is reduced.



③ Block the outdoor unit from direct sunlight. This saves energy.



### DRY

The humidity at which humans feel comfortable

When air contains too much moisture, humans feel clammy. Humidity is related with temperature and wind. The humidity at which humans feel comfortable is 60% ~ 75% RH. in summer, 55% ~ 70% RH. in winter.

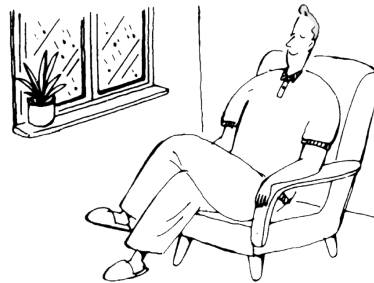



# AIR FLOW VELOCITY AND DIRECTION ADJUSTMENT

## HOW TO CHANGE THE AIR FLOW VELOCITY AND DIRECTION

AIR FLOW velocity and direction can be selected as required.

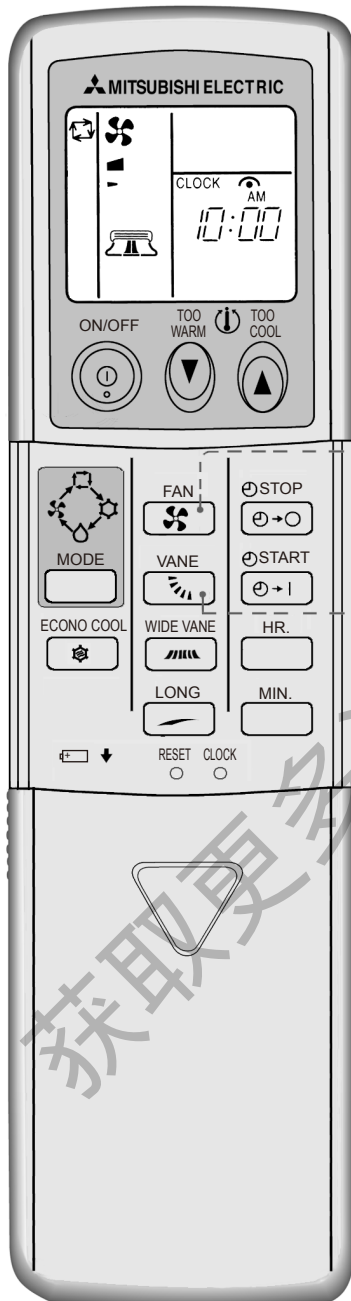







To change the AIR FLOW velocity, press the  button.



Each time the button is pressed, fan speed is changed in sequence, from  [Lo]  [Med]  [Hi]  [AUTO].

- To cool the whole room, use the  (Hi) mode.
- If the sound of the air conditioner operation disturbs your sleep, use the  (Lo) mode.

To change the AIR FLOW blowing direction vertically, press the  button.





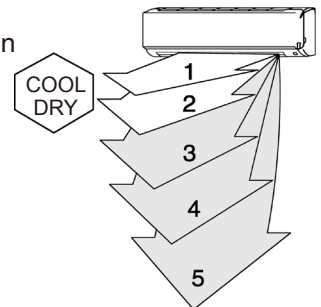

Each time the button is pressed, angle of horizontal vane is changed in sequence, from  (1) →  (2) →  (3) →  (4) →  (5) →  (SWING) →  (AUTO)

## RECOMMENDED HORIZONTAL VANE RANGE

- Use in the  (AUTO) position usually.
- Use positions  (1) or  (2) position (COOL, DRY) when adjusting as required.



## NOTE

- In the cooling or drying operation, when the air conditioner is operated with AIR FLOW blowing down  (4) or  (5) for 1 hour, the AIR FLOW direction is automatically set to level to prevent condensed water from dropping.
- Adjust the vertical AIR FLOW direction using the remote controller. If the horizontal vane are moved manually, it may cause trouble.
- The direction of AIR FLOW at this place  (1) →  (2) →  (3) →  (4) →  (5) just a sketch map and it does not indicate the actual of the vane.



# AIR FLOW VELOCITY AND DIRECTION ADJUSTMENT

## Auto air flow direction control operation

When the AUTO mode is selected with the  button, the position of the horizontal vane are automatically set to correspond to the operation mode to perform effective operation.

(1) COOL, DRY  
The AIR FLOW blows level.

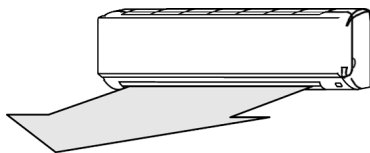

(2) FAN  
The AIR FLOW blows down.

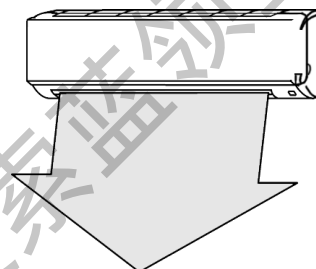

Press the  button to change the direction of the air flow.

Each time the button is pressed, the angle of the vertical vane is changed in sequence,

from  →  →  →  →  (swing) →  → (to) 

## THE RANGE OF THE AIR FLOW

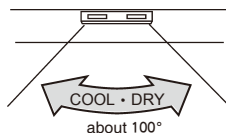

### Swing operation

- By using the vertical vane and horizontal vane swing operation, air flow can reach all corners of the room.

### Note

- Use remote controller to adjust the direction of the air flow. If adjust manually, a damage may occur.



# LONG OPERATION

For AIR FLOW to reach a Long distance, use the long operation.

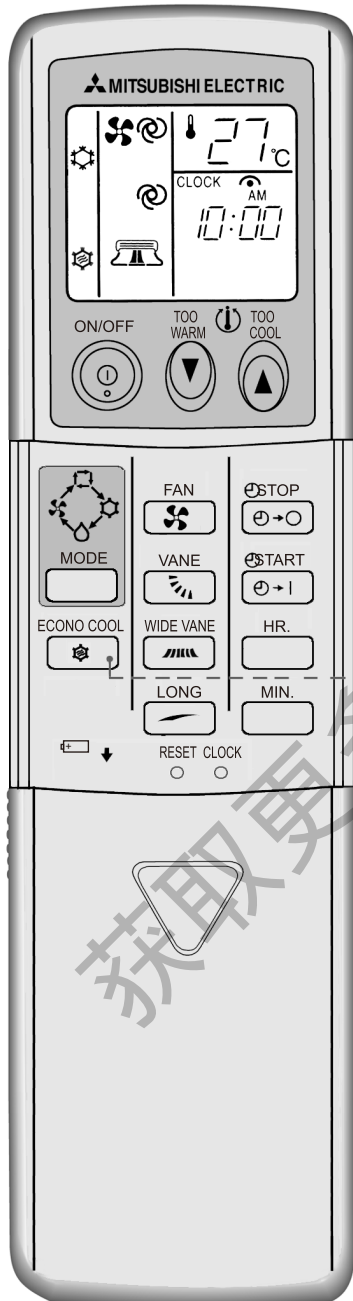

## HOW TO USE LONG OPERATION

Perform the following operations while the unit is operating.

Press the  button.

The fan speed increases.  
When the fan speed is set to  (AUTO), the fan speed is higher than a fan speed determined by the room temperature and the set temperature.  
In addition, the HORIZONTAL VANE moves to the position for LONG mode.

### Mechanism of the LONG operation

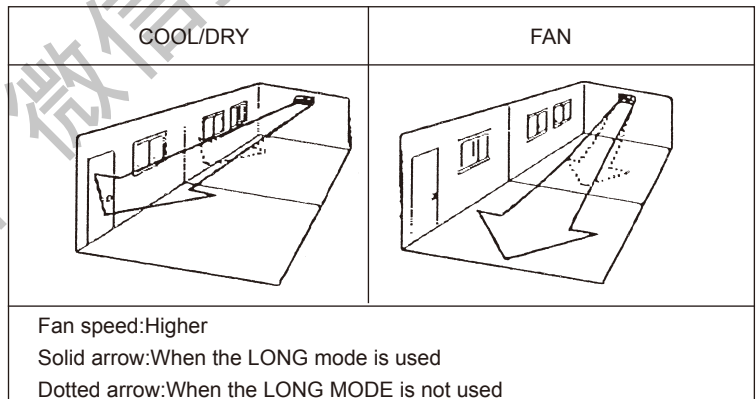

In the following example, the VERTICAL VANE is set to  (front).





To Release the LONG mode.



Press the  button again.

LONG mode is also released in the following ways.

- By pressing the  button
- By pressing the  button (only during COOL mode)

Even when the LONG mode is being used, the air may not reach a long distance due to the installation location of the air conditioner.

In this case, press the  button to set the fan speed to  (Hi), and then press the  button.

Press the ,  and  buttons, temperature buttons and the ON/OFF timer are available.



# ECONO COOL OPERATION (HEALTHY, COMFORT, ECONOMICAL OPERATION)

Use this operation when you want to be comfortable in cool mode even with energy saved.

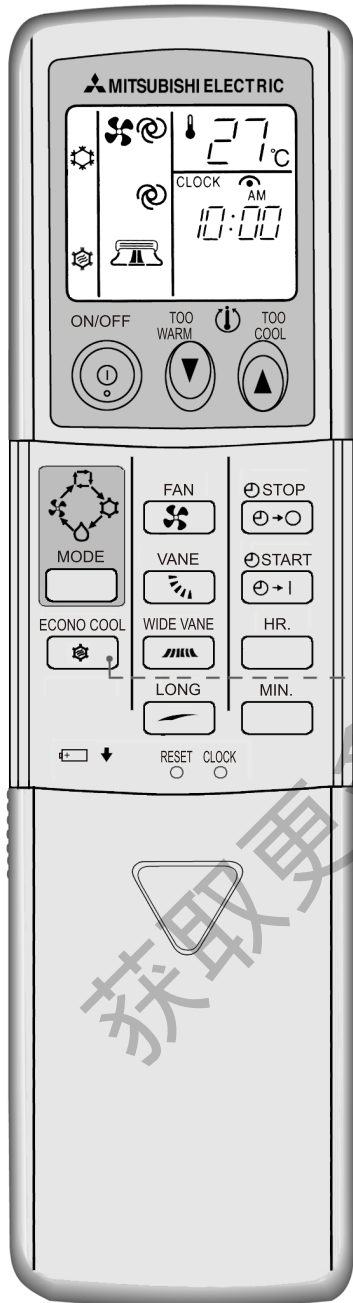

## TO SELECT ECONO COOL OPERATION

Perform the following operations while the unit is operating.

■ Press the  button  
 When the ECONO COOL operation is selected in COOL mode, the air conditioner performs swing operation in various cycle according to the temperature of indoor heat exchanger.  
 Also SET TEMPERATURE is automatically set 2°C higher than in COOL mode.





● To release the ECONO COOL operation:

■ Press the  button again.

What is "ECONO COOL"?

ECONO COOL operation changes the control mode from conventional room temperature control to human body feeling control. In initial 10 minutes of operating, the air flow blows downwards to cool the living area at first, and then it blows upwards to cool the whole room. And the swing operation is performed according to the air outlet temperature. The air flow blows downwards periodically to stimulate human body by cooling wind. When the air outlet temperature is low, the downward blow time is short, otherwise it is slightly long. So it may prevent overcooling and unwell caused by a long time downward blows. The variations of room temperature is same as that of conventional air conditioner. Because human body is cooled ahead of the whole room, and is stimulated by periodic cooling wind, so even though the room temperature is 2°C higher than that of conventional air conditioner, you may have the same cooling feeling, (e.g. you may have the same cooling feeling in ECONO COOL mode while the room temperature is 26°C as in constant cool mode while the room temperature is 24°C) as a result, it can save about 20% energy.

**NOTE**

- ECONO COOL operation is available only in MANUAL COOL mode.
- When the  button is pressed or the operation mode is changed during the ECONO COOL operation, ECONO COOL operation is released.
- The  button, the  or  button and ON/OFF timer are available.







# TIMER OPERATION (OFF TIMER·ON TIMER)



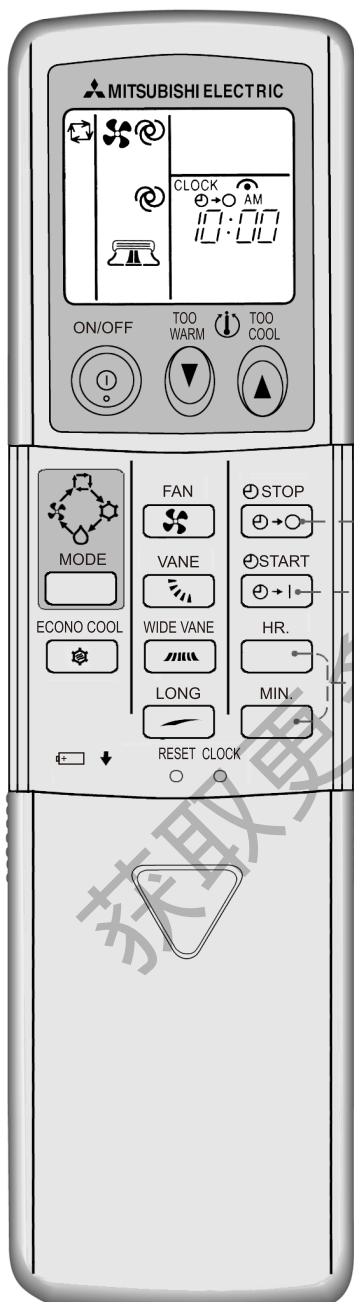

## TIMER

It is convenient to set the timer for the time when you go to bed, when you get home, when you get up, etc.



## HOW TO SET THE ON TIMER

**1** Press the  button during operation.  
Each time this button is pressed, the operation mode is alternates between ON and OFF.





**2** Use  and  buttons set the time of timer.  
Once press  button, the time will increase 1 hour.  
Once press  button, the time will increase 10 minutes.

How to release the timer.

Press the  button.

## HOW TO SET THE OFF TIMER

**1** Press the  button during operation.  
Each time this button is pressed, the operation mode is alternates between ON and OFF.

**2** Use  and  buttons set the time of timer.  
Once press  button, the time will increase 1 hour.  
Once press  button, the time will increase 10 minutes.

How to release the timer.

Press the  button.

## HOW TO COMPILE THE TIMER

ON timer and OFF timer can be set together.  
“↑” and “↓” display shows the order of the OFF timer and ON timer operation.

## NOTE

- ON timer and OFF timer can be set simultaneously.
- Hour set and 10 minutes set are both available.
- During or after setting the timer, if the  button is pressed, the timer will be released, and the air conditioner will be stopped.
- The maximal time which is set is 24 hours.
- If the present time is not set, the timer will not operate.

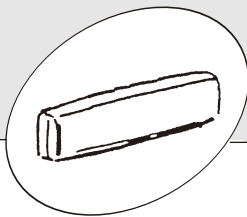

# WHEN THE AIR CONDITIONER IS NOT GOING TO BE USED FOR A LONG TIME

When it is not going to be used for a long time:

- 1 Perform FAN operation for 3 or 4 hours to dry the inside of the air conditioner.
  - Before perform fan operation, please set the unit work under the cool mode, and select the highest temperature.

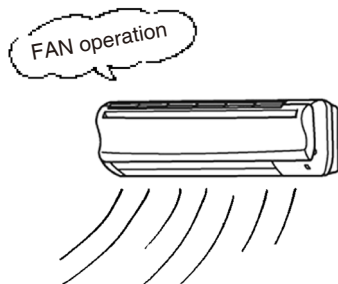

- 2 Turn off the breaker.

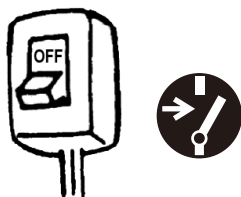

## ⚠ WARNING

Turn off the breaker when the air conditioner is not going to be used for a long time.  
Dirt may collect and may cause a fire .

- 3 Remove the batteries from the remote controller.

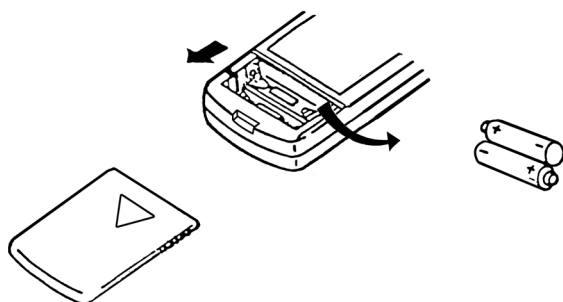

When the air conditioner is to be used again:

- 1 Clean the air filter and install it in the indoor unit .  
(Refer to page 46 for cleaning it.)

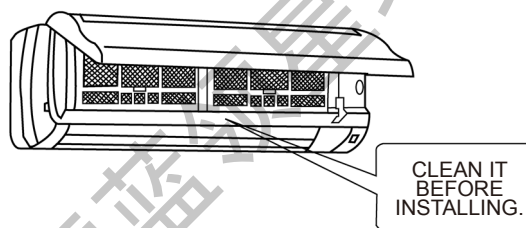

- 2 Check that the ground wire is connected correctly.

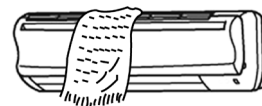

- 3 Check that the air inlet and outlet of the indoor/ outdoor unit are not blocked.

## ⚠ WARNING

Apply grounding.

- Do not connect a grounding wire to a gas pipe, water pipe, lightning rod or grounding wire of a telephone.
- If a grounding is absent or incorrect, it may cause an electric shock.



# MAINTENANCE

## Before starting maintenance

Turn off the breaker.

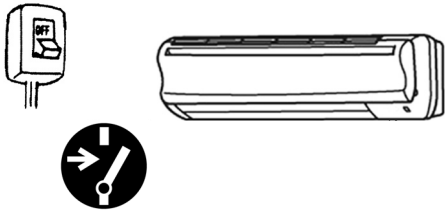

## Cleaning the indoor unit

Clean using soft dry cloth.

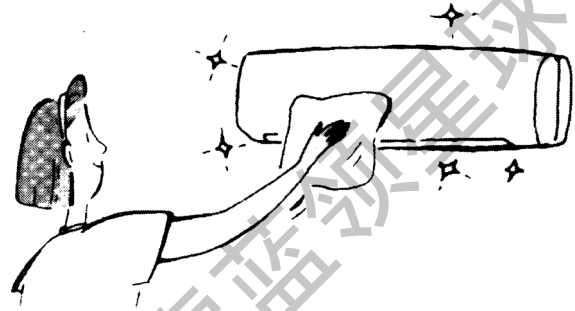

### ⚠ CAUTION

When the unit is to be cleaned, switch it off and turn off the breaker. Since the fan rotates at high speed during operation, it may cause an injury.

Do not use gasoline benzine, polishing powder, detergent and insecticide, or the unit may be damaged.

### ⚠ CAUTION

Do not open the front panel up past the level position.  
The panel may come off in order to prevent it from being damaged.

The front panel may also come off if the upper part of the front panel is pulled down.

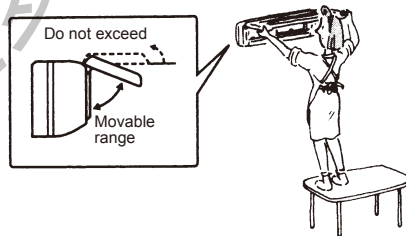

If the front panel comes off, attach it as explained below.

Keeping the front panel level with one hand, insert the hinges one by one with the other hand into the notches at the left, right and center of the top of the indoor unit until they click into place. (①) Then, close the front panel. (②)

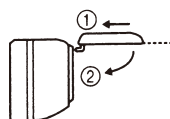

Keep the front panel level and insert the hinges into the notches.

Do not step onto an unstable bench when maintaining the unit, etc. This may cause an injury, etc. If you fall down.



# CLEANING THE CATECHIN FILTER

When the front panel is to be opened, do not open it up to the level position. If you do, the front panel may come off.

Cleaning the catechin filter.  
(about once every 2 weeks)

- 1** Remove the catechin filter.

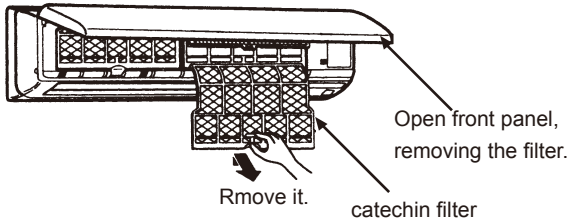

## CAUTION

When the catechin filter is to be removed, do not touch the metal parts of the indoor unit. It may cause an injury.

- 2** Clean dirt from the catechin filter using a vacuum cleaner or by washing with water.

- If dirt is conspicuous, wash with a solution of detergent in lukewarm water.
- If hot water (50°C or more) is used, it may be deformed.



- 3** After washing with water, dry well in the shade.

- Do not expose the catechin filter to direct sunlight or heat from a fire when drying it.

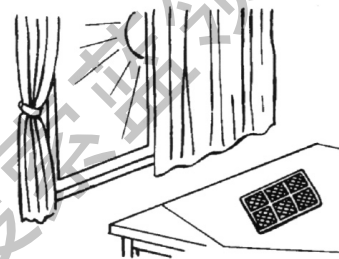

- 4** Install the catechin filter.

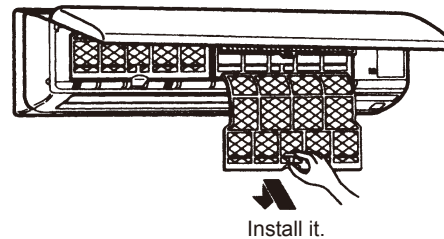

Function of the CATECHIN filter: Along with the resolution of the CATECHIN (composition of green tea), the odour of cigarette and sweat is eliminated, furthermore the germ is restrained to develop, grow up, and breed. (test method: Fiber product's quantitative germproof test method of Japanese textile inspection association.)

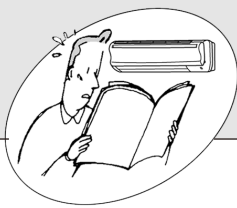

# BEFORE CONTACTING THE SERVICEMAN, CHECK THE FOLLOWING AGAIN

The air conditioner cannot be operated.

Check the following.

- 1 The breaker is turned on and fuse is not blown.

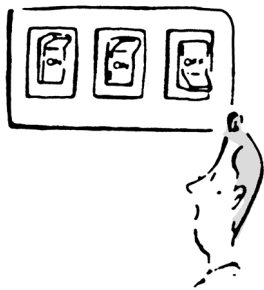

- 2 The ON-timer is not set.



Cannot be cooled sufficiently.

Check the following.

- 1 The temperature setting is correct.



- 2 Air filter is not dirty.

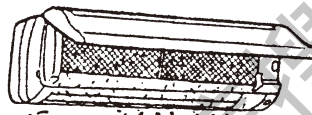

- 3 Outlet of the outdoor unit are not blocked.

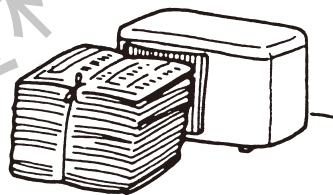

Display of the remote controller does not appear. The remote control signal cannot be received if it is not near the air conditioner.

- 1 The batteries are exhausted.

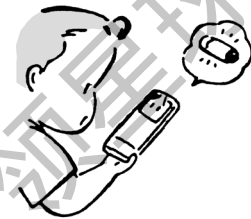

- 2 The polarity(+,-)of the batteries is confused.



When a power failure occurs. → Check the following.

The air conditioner is kept stopping. After the power is restored, pressing the ON/OFF button again.

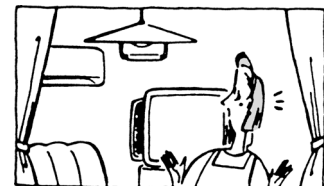



Even if the above items are checked, when the air conditioner does not recover from the trouble, stop using the air conditioner and consult your dealer or service center.

Note the following cases:

- The remote control signal may not be received in a room with an electronic ON/OFF type fluorescent lamp (inverter type fluorescent lamp, etc.) is used.
- In a weak radio wave area, when the air conditioner is operated, noise may be generated in SW radio reception.
- When thunder is heard, stop operation and pull out the power plug or turn off the breaker. Otherwise, the electrical parts may be damaged.



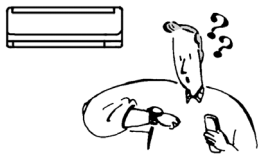

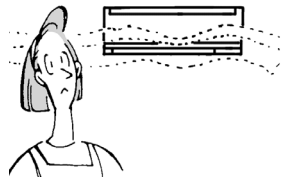
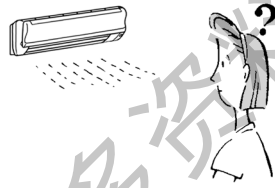
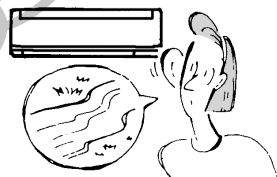
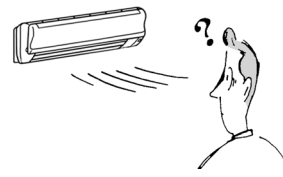
# WHEN YOU THINK THAT TROUBLE HAS OCCURED

QUESTION	ANSWER (not a malfunction)
<p>The air conditioner cannot be operated about for 3 minutes when re-started.</p> 	<ul style="list-style-type: none"><li>■ This protects the air conditioner by instructions from the microprocessor. Wait.</li></ul>
<p>Cracking sound is heard.</p> 	<ul style="list-style-type: none"><li>■ This sound is generated by the expansion/contraction of the front panel, etc. due to change in temperature.</li></ul>
<p>The room smells funny.</p> 	<ul style="list-style-type: none"><li>■ The air conditioner sucks an odor adhering a wall, carpet, furniture, cloth, etc. and blow it out with air.</li></ul>
<p>Fan stops during the DRY operation.</p> 	<ul style="list-style-type: none"><li>■ If water condensing to the heat-exchanger evaporated again, the humidity increases. To prevent this, fan operation of the indoor unit stops when the room temperature has dropped sufficiently.</li></ul>
<p>The sound of water flowing is heard.</p> 	<ul style="list-style-type: none"><li>■ This is the sound of refrigerant flowing inside the air conditioner.</li><li>■ This is sound of condensed water in the heat-exchanger flowing.</li><li>■ This is the sound of the heat-exchanger defrosting.</li></ul>
<p>Air flow direction is changed during operation.</p> 	<ul style="list-style-type: none"><li>■ When the air conditioner is operated in the COOL or DRY mode, if the operation continues with air blowing down for 1 hour, the direction is automatically set to level to prevent condensed water form dtopping.</li></ul>

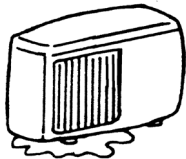

# WHEN YOU THINK THAT TROUBLE HAS OCCURED

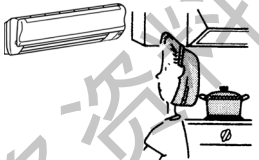
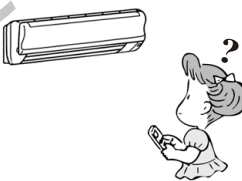
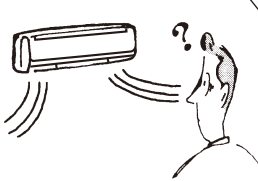
QUESTION	ANSWER (not a malfunction)
<p>Hissing sound is sometimes heard.</p> 	<ul style="list-style-type: none"><li>■ This is the sound when the flow of refrigerant inside the air conditioner is switched.</li></ul>
<p>water leaks from the outdoor unit.</p> 	<ul style="list-style-type: none"><li>■ During the cooling operation, pipe connector sections are cool and this causes water condensed.</li></ul>
<p>Mechanical sound is heard from the indoor unit.</p> 	<ul style="list-style-type: none"><li>■ This is the sound of the switch turning ON/OFF the fan or compressor.</li></ul>
<p>The room is not cooled or heated sufficiently.</p> 	<ul style="list-style-type: none"><li>■ The thermal load is high, because the exhaust fan or stove is in use. So the cooling capacity is not enough.</li><li>■ The cooling or heating capacity is not enough because the outdoor temperature is too high or too low.</li></ul>
<p>All the content displaying on the indoor unit are twinkling, and the horizontal vane doesn't work.</p> 	<ul style="list-style-type: none"><li>■ Check the horizontal vane is installed correctly.</li></ul>
<p>During operation, mirage is blown out from the air outlet of the indoor unit.</p> 	<ul style="list-style-type: none"><li>■ The moisture in the air meets with the cold air from the air outlet of the indoor unit, and cause the moisture condensed.</li></ul>





# INSTALLATION,RELOCATION AND INSPECTION

## INSTALLATION PLACE

Avoid installing the air conditioner in the following places.

- Where flammable gas could leak.

### ⚠ CAUTION

Do not install the unit where flammable gas could leak.

- If gas leaks and collects around the unit, it may cause an explosion.
- If the wireless receiver (TV, radio, etc.) has signal disturb where the signal is weak, a signal amplifier is advised to install to improve the receiving quality.

- Where there is much machine oil.
- Salty place such as the seaside.
- Where sulfide gas is generated such as a hot spring.
- Where oil is splashed or is filled with oily smoke.
- Where there is high frequency machine or wireless device (wireless phone or mobile phone).

## ELECTRICAL WORK

- Provide an exclusive circuit for power supply of the air conditioner.
- Be sure to observe the breaker capacity.

### ⚠ WARNING

- The customer should not install this unit. If this is done incorrectly, it may cause a fire, electric shock, injury by dropping of the unit, water leakage, etc.
- Do not connect using branched outlet or an extension cord, and do not attach many loads to one electric outlet. A fire or electric shock may result from poor contact, poor insulation, exceeding the permissible current etc. Consult your dealer or a specialist.

### ⚠ WARNING

- Air conditioner socket must apply grounding by a special grounding wire. Do not connect a grounding wire to a gas pipe, water pipe, lightning rod or ground wire of a telephone.
- If a grounding is incorrect or absent, it may cause an electric shock.
- Be sure whether there is a grounding wire and whether it is connected correctly.
- Install an earth leakage breaker depending on the place where the air conditioner is to be installed (humid place, etc.). If the earth leakage breaker is not installed, it may cause an electric shock.

TV set, radio or other wireless receiver should be 3m or more away from the outdoor unit. However, if there still is signal disturb, the distance should be lengthened.

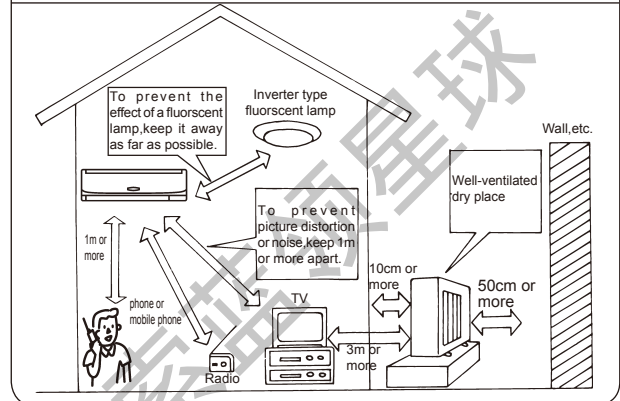

## INSPECTION AND MAINTENANCE

- When the air conditioner is used for several seasons, the capacity may be lowered due to dirt inside the unit.
- Depending on the use condition, an odor may be generated or dehumidified water may not drain out smoothly due to dirt, dust, etc.
- It is recommended to apply inspection and maintenance (charged) by a specialist in addition to normal maintenance. Consult your dealer.

## ALSO CONSIDER OPERATION SOUND

- Do not put an object around the air outlet of the outdoor unit. It may cause lowering of capacity or increase operation sound.
- If abnormal sound is heard during operation, consult your dealer.

## RELOCATION

- When the air conditioner is to be removed or reinstalled because of rebuilding, moving, etc. special techniques and work are required.

### ⚠ WARNING

Repair or relocation should not be done by the customer. If this is done incorrectly, it may cause a fire, electric shock, injury by dropping of the unit, water leakage, etc. Consult your dealer or service center.

If the power supply cord is damaged, be sure to replace it with the special cord or the special wire assembly bought from the air conditioner factory or the service department.

If you have any questions, consult your dealer.

# SPECIFICATIONS

Model	MSD-LD23VD-H1
Electric-shock proof protection	I Type
Power supply	220V ~ 50Hz
Cooling capacity (kW)	6.20
Cooling power input (kW)	2.15
Cooling rated current (A)	10.2
Air flow volume (m <sup>3</sup> /h)	900
Refrigerant charging (kg)	1.9
Noise (Indoor unit)(dB(A))(Hi/Lo)	46/38
Noise (Outdoor unit)(dB(A))	50
Net weight (Indoor unit) (kg)	16
Net weight (Outdoor unit) (kg)	52
Dimensions H ×W×D (Indoor unit) (mm)	325 × 1100 × 261
Dimensions H×W×D (outdoor unit) (mm)	655 × 860 × 330
Connect pipe length (m)	5
Highest work pressure of discharge(MPa)	2.74
Highest work pressure of suction(MPa)	1.01
Maximum work pressure of heat exchange(MPa)	3.3
Limit pressure of accumulator(MPa)	1.31

Notes: ❶ Guaranteed operating range:

		Indoor	Outdoor
Cooling	Upper Limit	32°C DB 23°C WB	43°C DB —
	Lower Limit	21°C DB 15°C WB	21°C DB —

❷ The noise value is tested in the condition of laboratory (No background noise).

❸ Test standard : GB/T 7725 GB4706.32-2004

获取更多资料 微信搜索蓝领星球



MITSUBISHI ELECTRIC CORPORATION

HEAD OFFICE TOKYO BLDG. MARUNOUCHI TOKYO JAPAN 100-8310

WG79A420H01